

CONVENIENT & SAFE ONLINE SHOPPING ON  
SHOP.BITO.COM

More than 5,000 quality products | Direct from the manufacturer |  
Comprehensive customer service | On-site advice | Fast track delivery |

# PRODUCT CATALOGUE

Modern warehousing and logistics solutions

Bins & containers



Shelving & Racking



Steps & Ladders



Environmental protection



Identification & safety



In-house transport



Workstation systems



Cabinets & Cupboards



Storage and order  
picking solutions



A BIT OF YOUR LIFE.



**BITO**  
STORAGE SYSTEMS  
NORDIC

# Our services - Your benefits

## ORDERING IS EASY:

### Hotline:

DK +45 70 21 51 51  
SE +46 (0) 42 151910  
FI +358 10 324 6510

### Email:

DK info@bito.dk  
SE info@bito.se  
FI info@bito.fi

### Online shop:

www.bito.com

## YOUR ONLINE BENEFITS:

- More than 5,000 products
- Product filter
- Payment against invoice, with credit card or with PayPal

## CUSTOMER SERVICE

Our customer service teams look forward to your call. You can count on us to assist you not only with information on our products, but also when it comes to troubleshooting or if you want to return a product.

## QUALITY PROMISE & WARRANTY

We provide a two-year warranty on all BITO products. Many product lines such as our plastic bins and containers come with a 5-year quality promise.

## SUPPORT & ADVICE

A customer service centre with knowledgeable and dedicated staff is available every day to assist you with any questions you may have. If the project grows more complex than expected, our 40 local representatives can be consulted at any time to provide you with personal advice.

## FAST TRACK DELIVERY

Since we ship our products directly from our manufacturing plants, we are able to offer short delivery times for our huge product range with more than 5,000 items. Almost 90 per cent of all products ordered through our catalogue or our webshop are handed over to a freight forwarder within 72 hours. We work with one of the largest and best-known logistics service providers in Europe to deliver your products.

## PROJECT PLANNING

We deliver customised projects. For optimum results, we start with a thorough analysis of your product structures and on-site storage and picking processes before suggesting the appropriate shelving or racking system or the ideal combination of several systems. Our in-house designers, drafters and structural engineers develop a solution that is perfectly tailored to your challenges and application.

## ASSEMBLY SERVICE

If you are short of time or staff to set up your shelving or racking installation, we will be pleased to assist you. Our professionally trained staff makes sure that assembly is carried out efficiently and in line with all safety regulations – if requested at a fixed price. Contact us – we are happy to help!

## AFTER-SALES SERVICE

To complete our services we also offer regular shelving and racking inspections. Depending on national safety regulations, operators of shelving and racking are legally obligated to have their facilities inspected at least once a year by a qualified person. BITO provides this inspection service. Our inspectors are trained and authorised to conduct all necessary tests in compliance with the safety regulations applicable in your country!

BITO. SMART. COMPETENT. RELIABLE.





## LOGISTICS IS THE KEY TO SUCCESS..

Dear Business Partner,

Over the last 2-3 years, we have seen a world in constant change. Logistics challenges, shortage in supply of raw material, but also new technologies, products and commercial patterns have seen the light of day.

Throughout our more than 175 years' history, BITO has been changing, too, developing and proactively seeking new ways of creating a successful logistics platform for our customers. Efficient logistics management is fundamental to any business that wants to stand out from competitors and inspire their customers.

Providing a secure constant supply chain as well as improving the quality and efficiency are challenges that many companies in almost all sectors face on their way to success. This is exactly where we can accompany you as your partner to cater for all your intralogistics requirements and keep your supply chain running smoothly.

It is our mission to contribute to the success of our customers through innovative storage and material flow solutions. Our tools are high quality products and services to help you achieve durable and sustainable results and offer you real added value in all areas of your application.

Our product catalogue holds more than 5,000 quality products to make your warehouse efficient, neat, and green. You can order all products directly or have one of our in-house sales specialists or field representatives make a custom concept in advance.

We look forward to supporting you and wish you lots of success!

Sincerely yours,  
BITO Nordic Team

# Table of contents



## Who we are 6

What we do	8
Our services	10

## Plastic bins & containers 14

### Our product range in detail 16

EPS or EPP foam inlays	20	Trays for automated storage	78
Storage bins with pick opening/Small parts storage	22/36	Nesting and folding containers	80
Modular stacking containers EMB/		Containers with fork entry shoes 800 x 600	112
European size stacking containers	50/52	Large volume containers, plastic pallet boxes	128
XLmotion containers/Small parts containers KLT	66/70		

## Shelving & racking 136

### Our product range in detail 138

Boltless shelving	144	Order picking of palletised loads	210
Shelving with extra large shelves	148	Order picking of light and medium-weight loads	215
Wide span shelving	186	Cantilever racking	226
Pallet racking	194	Sheet racks, wire-mesh partitions	242/243

## Steps & Ladders 244

Access ladders and A-frame ladders	246	Kick steps/Step stools	257
Platform steps	255		

## Environmental protection 258

Drum racking	260	Drum pallets	263
Spill trays	261	Containers for hazardous substances	264
Spill prevention systems	262	Spill containment shelving	265

## Identification & Safety 266

Spray paint marking	268	Security mirrors	283
Edge and corner buffering	270	Display systems	284
Traffic and pedestrian control	272	Document pockets	287
Flexible impact barriers/racking protection	274/278	Stock identification	290
Impact protection/Rack end barriers	279/282	Labels/Label holders	291/293

## In-house transport

LEO Locative	296	Table trolleys	318
Folding sack trucks, tyre trucks, hand trucks	304-305	Shelf trolleys	321
Hand pallet trucks	306	Order picking trolleys	328
TOTALSTOP central locking system, swivel castors	309	Roll containers/Cantilever trolleys/ Sheet material trolleys	331-333
Transport dollies/Swan-neck handle trolleys/ Folding platform trucks	310-312	Transport dollies/Tipping skips	334-337
C+C-trucks/Platform trucks with handle bar	313-315	Roller conveyors and accessories	338
Platform trucks with mesh/timber sides	316-317	Skatewheel expandaveyors	343

## Workstation systems

BITO-TEC	346	Workbenches	350
----------	-----	-------------	-----

## Cabinets & Cupboards

Utility cupboards	360	Cube lockers	374
Cabinets & Cupboards	364	Garment lockers	376
Janitorial, garment and file lockers	368	Z-fronted wardrobes	378
Cabinets for environmentally hazardous goods	370	Cloakroom bench seats	379
Utility cupboards with sliding doors	371	Drawer cabinets	380

## Storage and order picking solutions

Multi-tier installations/mezzanines	388	Drive-in racking	396
Carton live storage	390	PROflow Pallet live storage	398
Automated bin and tray storage	392	Cantilever racking	400
PRO Pallet racking	394	PRomobile racking	402

## Keyword Index

BITO International/Sales points	408
---------------------------------	-----

294

344

358

386

404



## PREMIER QUALITY MANUFACTURED IN OUR OWN PLANTS.



USA

BITO Shelving and racking systems are manufactured in our plant at Meisenheim.

We provide storage solutions to suit every need, whether your goods are small or large, light weight or heavy weight, bulky or long. For load capacities ranging from 50 kg to 4.5 tonnes per storage level.

BITO Plastic bins and containers are manufactured in our plant at Lauterecken.

Customers can choose from a wide range of storage, transport and order picking bins and containers for use in any industry and for almost any application.

Our plant in Zimna Wódka is the second pillar ...

... for manufacturing BITO shelving and racking. This production facility uses the same state-of-the-art technology as our production plant in Meisenheim.

We rely on state-of-the-art technology ...

... for manufacturing all our shelving and racking systems. The high degree of automation in profiling, folding, punching and bending ensures that your products are always dimensionally accurate and have a consistent product quality. Our state-of-the-art equipment provides smooth operation and efficient order processing.





## Our subsidiaries

With our subsidiaries in Europe, Asia and North America as well as partnerships in many other countries, we are always close to our customers!

## Customer specific demands ...

... are met by the BITO R&D department. Customer focus and application orientation are top priorities for our R&D engineers. They coordinate the introduction of a new bin from the first steps of development to the three-dimensional digital model and optimise prototypes until they are ready for serial production on powerful, cutting-edge injection moulding machines. To meet special requirements, our plant in Lauterecken offers additional options. These include, for example, automatic barcode labeling or container milling and drilling to comply with fire protection regulations.

## OUR COMMITMENT TO SUSTAINABILITY

### Working for a sustainable future



Small parts storage in bins made from sunflower seed shells

We use products made from recycled materials! BITO products help you to optimise workflows in storage and order picking areas and to reduce your carbon footprint. Our metal and plastic products are made exclusively from recyclable materials. Plastic bins and containers which are no longer used, are returned to the material cycle after they have been shredded in our recycling plant. In many cases, modern technology opens up the possibility to re-use steel, too, and to create a closed loop for steel products. For us, holistic corporate management means to harmonise the goals of the people who are working for and with our company and the goals of society with environmental demands.

### BITO – the one stop shop

Shelving & racking, bins & containers, workshop equipment & accessories – the BITO product range offers everything you need for material handling and warehousing. Whether you need shelving for light-weight goods or heavy-duty pallet racking. Whether you need a small-size storage bin or a large volume container, a product label or a hand pallet truck. The BITO product range offers more than just the basics for those who “only” need a shelving unit or a bin. We also supply the full range of components, the know-how and a competent concept-to-completion service for realising complex, state-of-the-art storage and order picking facilities. Your benefit: A personal project coordinator will take you from start to finish.

#### FACTS AT A GLANCE

**97%**

In 2019, we recycled 96.76% of our waste.

**60%**

of lighting energy is being saved by replacing traditional lighting sources with LEDs

**12% & 20%**

less energy needed for our new injection moulding machines.

**>1MILLION** kWh/a

of solar energy are generated at our sites in Meisenheim and Lauterecken.

## Our shelving & racking portfolio ...

... includes boltless or bolted shelving, shelving with extra large shelves, wide span and heavy duty shelving, pallet racking, cantilever racking, mobile shelving and racking, multi-tier facilities, carton and pallet live storage as well as automated storage installations. Whether you opt for a conventional solution or an automated live storage installation – the BITO team will be pleased to assist you in making the right choice for your application.

## Our bins & containers

BITO provides a huge range of bins and containers in any size and for any application. Discover our bins for storage, material handling and order picking, our stacking containers in European standard sizes and our successful distribution container series. In addition, we offer bins and trays for automated small parts storage and plastic pallet boxes.

## A broad range of workshop equipment ...

... such as workbenches, transport dollies, order picking and shelf trolleys, cabinets and cupboards, steps and ladders, product markings and labels as well as safety equipment rounds off our product portfolio. Whatever you need for material handling and storage – you can count on BITO as your single source supplier!





# Intelligent supply shelving

## Automated, BITO-cloud monitored replenishment

Intelligent system for cloud-based inventory monitoring and automated replenishment control.

### Your advantages at a glance:



Officially approved and fully automated inventory method



Replenishment requests are triggered automatically



Replenishment requests that come in too late and maverick buying are not accepted



Avoids out-of-stock situations



Identifies non-regular consumption peaks



Reduces tied-up capital and space requirement



Ideal for suppliers as a vendor managed inventory solution



Suitable for liquids, bulk materials, products sold by the yard/metre, goods in bins and cardboard packaging

CONTACT US FOR MORE INFORMATION AT  
+49 6753 122 0 or on [ordershelf@bito.com](mailto:ordershelf@bito.com)

**BITO**  
LAGERTECHNIK



## How does this solution work?

Weight sensors report stock levels to the control unit. Data is transmitted to the cloud by being converted into radio waves. As soon as the minimum stock level is reached, the system automatically sets off an alert to you.



### Sensor unit

- ☑ Wireless, smart, battery operated
- ☑ Can be added later on whenever required

### Control unit

- ☑ Covers an area of 150,000 m<sup>2</sup> or 2,000 sensor units
- ☑ No connection to your IT organisation or WLAN connection necessary



### BITO Cloud

- ☑ Software that manages sensor units, material allocation, stocks, consumption points and email alerts.
- ☑ Secure & GDPR compliant European cloud platform

## Compatible with all standard BITO bins and containers:



Storage bins SK



European size stacking containers XL



Storage and handling bins RK



C-item bins CTB

For more information refer to

[www.bitocom/de-de/loesungen/produktneuheiten/self-ordering-shelf/](http://www.bitocom/de-de/loesungen/produktneuheiten/self-ordering-shelf/)

Standardised warehouse management by implementing best practices

# PULPO Warehouse Management System

The **PULPO WMS** handles both inventory management and process control (order control) in your warehouse by implementing best practices. The **PULPO WMS** can be used as stand-alone system or it can be integrated by interfaces into higher-level host systems, e.g. an ERP or merchandise management system or an online shop system.

Design your warehouse layout with a 3D builder! Flexibility and configurability are at your fingertips!

- Little training required
- Intuitive operation
- Low investment
- Use of mobile devices
- Hardware and software from a single source
- Immediate implementation
- Cancellation on a monthly basis



## Unbeatably efficient

**The PULPO WMS** is a cloud-based warehouse management system for small and medium-sized enterprises (software as a service, SaaS). Digitise your warehouse processes & increase your productivity. Benefit from the advantages of the **PULPO WMS!**



Intelligent tracking of vehicles, load carriers and storage locations.

## Vehicle tracking

- Tracking of parameters such as temperature, geo-position and humidity in real time
- Immediate, secure and transparent shipment tracking
- Automated identification of multiple shipments enables simple and transparent fleet management



[bito.com/en-gb/vehicle-and-shipment-monitoring/](https://bito.com/en-gb/vehicle-and-shipment-monitoring/)

## Tracking solution for shipping pharmaceuticals

- Real-time temperature and humidity monitoring
- GMP, GDP and MHRA compliant
- Hygienic storage and cold chain compliance
- GEO position tracking



[bito.com/en-gb/shipment-monitoring/](https://bito.com/en-gb/shipment-monitoring/)

## Warehouse condition monitoring

- Seamless condition monitoring
- Real-time temperature and humidity monitoring
- The cloud solution allows accessibility across all locations



[bito.com/en-gb/warehouse-condition-monitoring/](https://bito.com/en-gb/warehouse-condition-monitoring/)



**Storage, transport and order picking containers**

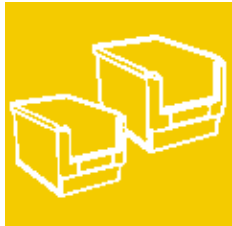

BITO provides an impressive range of bins and containers for any application - from bins and containers for storage and order picking over various stacking container series in European standard sizes, multi-purpose containers, bins and trays for automated small parts facilities to pallet containers.

Our R&D design and construction engineers take pride in working out the optimum, customer-oriented solution. Backed by the most advanced technical facilities, our engineers are able to respond to specific customer demands and to coordinate the introduction of a new BITOBOX □ from the initial steps to the three-dimensional, digital model, from the prototype to the final product ready to be manufactured in series.





... to suit any application!



BINS & CONTAINERS

# BITOBOX





**Contents**

**Our plastic bins and containers ..... 18**

**Key to our symbols..... 19**

**Create economic sustainability with BITO plastic bins & containers! ..... 20**

**Sustainable processes for our business line “Plastic bins & containers” ..... 21**

**Storage bins with pick opening ..... 22**

**Small parts storage bins and containers ..... 22**

Storage bins SK ..... 22

Louvered panel kits complete with bins ..... 24

Louvered panels ..... 25

Bin racks and bin trolleys ..... 27

Boltless shelving complete with SK bins ..... 28

Storage bins PK ..... 29

**European size storage bins and containers ..... 30**

European size stacking containers XL ..... 30

European size stacking containers BN..... 32

Pick walls - ready-to-use setups consisting of stacking containers..... 34

**Small parts storage ..... 36**

**Supply chain logistics with C-item bins ..... 36**

C-item bins CTB ..... 36

Kanban bin shelving for small parts ..... 40

**Storage and handling bins ..... 40**

Storage and handling bins PK..... 41

Storage and handling bins RK..... 42

Boltless shelving complete with RK bins..... 46

**Display storage systems ..... 48**

Tilt-open container modules ..... 48

Stand alone tilt-open container cabinets ..... 49

**Modular stacking containers EMB .... 50**

Modular stacking containers EMB ..... 50

<b>European size stacking containers ... 52</b>	<b>Folding containers ..... 102</b>
<b>European size stacking containers ..... 52</b>	Folding boxes EQ..... 102
European size stacking containers XL ..... 52	Folding distribution boxes MFB ..... 106
European size stacking containers XL with perforated base and sides ..... 56	<b>Stack and nest containers ..... 108</b>
European size stacking containers XL with ribbed base RX ..... 58	Stack and nest containers U-Turn..... 108
European size stacking containers XL with double base ..... 59	Stack and nest containers DSL ..... 110
Insert dividers ..... 60	Stack and nest containers DST ..... 111
Slot-in divider strips..... 60	<b>Containers with fork entry shoes 800 x 600 ..... 112</b>
Insert bins ..... 61	<b>Multi-purpose containers ..... 112</b>
Cut out moulded inserts for components or tools..... 62	Multi-purpose containers MB..... 112
European size stacking containers BN..... 64	<b>European size stacking containers ..... 116</b>
<b>Containers for automated systems ... 66</b>	European size stacking containers XL ..... 116
XLmotion containers for automated systems ..... 66	European size stacking containers XL with double base ..... 117
<b>Small parts containers ..... 70</b>	<b>Heavy duty containers ..... 120</b>
Small parts containers KLT ..... 70	Heavy duty containers SL..... 120
Small parts containers KLT with ribbed base ..... 74	<b>Multi-trip transport solution ..... 126</b>
Small parts containers KLT with double base..... 75	Pallet top cap and pallet dolly ..... 126
Insert bins ..... 77	<b>Large volume containers ..... 128</b>
<b>Trays ..... 78</b>	<b>Pallet boxes ..... 128</b>
Steel trays ..... 78	Pallet boxes ..... 128
Plastic trays ..... 78	Pallet containers CB1 / CB3 ..... 129
<b>Nesting and folding containers ..... 80</b>	<b>Foldable pallet boxes ..... 130</b>
<b>Multi-purpose containers ..... 80</b>	Foldable pallet boxes MAGNUM Optimum ..... 130
Multi-purpose containers MB..... 80	Large volume containers ..... 130
Multi-purpose containers MB with ribbed base ..... 86	<b>Large volume nesting and folding containers ... 131</b>
Multi-purpose containers MB with double base ..... 87	Folding bulk containers..... 131
Multi-purpose containers MB Food & Delivery ..... 88	<b>Pallets ..... 132</b>
BITO PharmaBOX..... 90	Plastic pallets ..... 132
Multi-purpose containers MB for pharmaceutical supply chains..... 92	<b>Case studies ..... 134</b>
Multi-purpose containers MB - Mail custom solution . 95	
Multi-purpose containers MB Eco..... 96	
Multi-purpose containers MB - special applications 100	
Easy peel label holders..... 101	





## BITO bins and containers: Top quality made in Germany



BITO bins and containers are produced in one of the most modern plants of the industry on high performance injection moulding machines with a clamping force of up to 27000 kN. In our finishing centre, a wide variety of bins and containers can be adapted to customer-specific requirements. The entire manufacturing process combines high levels of automation with utmost versatility.



### Marking and identification

Requests as to the application of logos and messages as well as bin and container identification are as diverse as our customers. The easiest way to realise these requests is by print-ons. BITO is able to do more than this: we offer all other options, too: from screen print, pad print, hot stamping and injection moulding to automated barcode labelling.



### Welding, milling, riveting

The use of bins and containers in automated storage installations means observing very narrow tolerances, particularly in view of base deflection. With vibration welded double base containers from our finishing centre, we perfectly meet this requirement. Other bin and container features can also be provided without any difficulty - our modern CNC milling machines realise precision holes, drainage holes and slots as required.



### Closed loop: recycling of used containers

We take back your used BITO bins and containers and recycle them to make new products. In this way we ensure a closed material cycle to support sustainability. We can also assist you if you wish to return bins and containers that are not from BITO. Please contact us!



## Environmental compatibility



Plastic bins and containers not used anymore will be ground in a recycling facility. The regranulated material will then be used to manufacture special application products. Bins and containers marked with this symbol are produced from plastic regranulate.

## 5 year promise on quality



All bins and containers with this symbol are granted a 5 year promise on quality - which is far more than required by law.

## Colours



Many bin and container types are available in special colours when ordered in quantities of 200 and more. Call us!

## Food safety



BITO bins and containers marked with this symbol are safe to come in contact with foods. For hygienic reasons, you should always clean bins and containers before storing or transporting foods.

## ESD



Bins and containers marked with the ESD symbol are made from dissipative material to protect electronic parts and components from damage caused by sudden electrostatic discharge.

## Polypropylene (PP)



Copolymer polypropylene guarantees a long service life, is resistant to most acids and alkalis, organic solvents and greases. In addition, it is odourless, mild on skin, food safe and recyclable.

## Recycled Polypropylene (PP-RE)



Recycled, granulated material. This symbol denotes that bins or containers have been manufactured from recycled polypropylene.

## Polystyrene (PS)



Polystyrene is a highly rigid material. Also available as transparent version.

## Base deflection

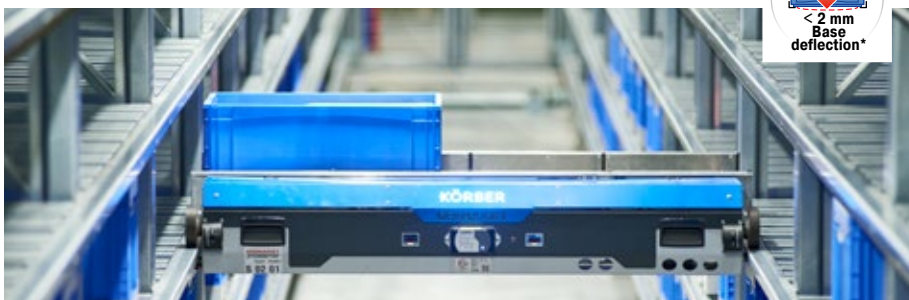

Bins and containers used in automated storage and retrieval systems (AS/RS) must meet special requirements. One of the most important criteria for use on bin carriers or on conveyors is a strong base to minimize deflection. This symbol shows the maximum base deflection of our bins and containers with uniformly distributed loads handled at an ambient temperature of 23°C. It is assumed that bins and containers are handled long side on and placed onto support profiles in AS/RS facilities. Ask us for more details!

## Temperature Resistance

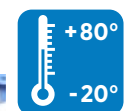

All indicated load capacities refer to an ambient temperature of 23°C. The dimensional stability of our bins and containers is also maintained during short cleaning processes within a specified temperature range. The symbol indicates limit temperatures.

## Create economic sustainability with BITO plastic bins & containers!

Plastic bins help speed up any company's logistics processes, thereby raising productivity levels and saving money and natural resources.

BITO offers a large range of bins & containers: practical storage bins, open-fronted picking bins, stacking containers in European standard sizes, space-saving folding boxes, Kanban bins for small items, large-volume and heavy duty containers, as well as bins and trays for automated storage. There is the right BITOBOX for any application!

Our bins and containers have been designed for a long service life. Accordingly, you will find our 5-year warranty symbol on many products of our bin range informing you of our 5-year quality promise, over and above the legal warranty.

Sturdy and versatile, with many ergonomic features, available in a wide range of standard versions or built to individual standards: BITOBOXES guarantee maximum protection as well as easy, cost efficient and environmentally friendly handling.



### OUR EXAMPLE PRODUCT: BITO DISTRIBUTION CONTAINERS MB

BITO MBs are the ideal answer to the demands of sustainable development throughout the entire value chain. They support manufacturers, logistics providers and end consumers alike in achieving their sustainability goals. MB containers come in European standard sizes and are an excellent alternative to disposable packaging. Compared to one-way cardboard packaging, our MBs have a lot of benefits:

- **Sturdy and hardwearing for a long service life**
- **Suited for storage, order picking and shipping**
- **No packaging waste**
- **Environmentally friendly and resource conserving**
- **Empty container nesting on return trips saves up to 75% of freight and storage costs**

MB containers can be complemented with a wide range of useful accessories. Combined with a snap-lockable drop-on lid and security seals, MB containers are ideal for shipping valuables as well as hazardous substances.



The BITOBOX MB with thermal insulation kit keeps medicines at the right temperature over a long period of time.

## Sustainable processes for our business line "Plastic bins & containers"

### OUR BINS AND CONTAINERS ARE CAPABLE OF BEING RECYCLED

Sustainability does not only focus on reducing emissions and complying with legal requirements. Acting sustainably also means to develop and implement a concept for the entire life cycle of a product.

### Multi-trip MB ECO containers are the environmentally friendly alternative to virgin materials!

Today, our bins and containers already contain 20% recycled material. Production surplus is regranulated in our own recycling facility and returned 100% into the production cycle. On request, almost all bin and container series can be made from regranulate (post-process plastic).

Particularly sustainability-minded customers can also opt for our MB distribution containers made from certified post-consumer plastic derived from end products that have completed their lifecycle.

Although process engineering limits colour options to black for the body of this MB box, customers still have the possibility of colour coding by fitting their MB box with lids in blue, yellow, green and red. Optional equipment such as hinged lids or stacking rails are the same as for the BITO MB standard series.

There is yet another advantage: The new MB ECO is a good alternative not only from an ecological, but also from an economic point of view, as it is somewhat cheaper to manufacture and therefore has a lower selling price than the standard MB container.

## OUR RECYCLING EXAMPLE: BITOBOX MB ECO

Our service special: Although our products are designed for a long service life, we want to make sure they are properly handled when they are no longer in use. This is why we offer our customers to return plastic bins to us that have completed their service life. These are recycled into regranulate which is used for producing new bins and containers. Check out this clever solution!



Multi-purpose containers MB Eco – stacked and nested





### Storage bins SK

Easy-to-view-'n-pick solution for small parts

- 9 variations in 5 base dimensions
- Straight sides and 90° corners allow good volume utilisation
- Integral moulded grips for safe handling
- The textured base and rounded edges ensure optimum travel characteristics on conveyors and in live storage systems
- Positive locators for added stacking safety
- Sturdy corner design provides additional rigidity
- Supplied with 1 label card per container

#### BITO-Plus



STORAGE BINS WITH PICK OPENING

**TOP SELLER!**  
SK1095

**BITOBOX SK**

**i** [www.mybitobox.com](http://www.mybitobox.com)  
Configure colours and logos online!



**i** BITO info  
(R) MB with ribbed base

External dimensions L x W x H mm	Internal dimensions L x W x H mm	Volume litres	Load capacity kg	Stacking load kg	Bin type	Pcs/pack	Ref. no.	Ref. no.	Ref. no.	Ref. no.
85 x 102 x 50	69 x 90 x 43	0,3	1		SK1095	60	2-19578	2-19579	2-19580	2-19581
160 x 103 x 75	139 x 87 x 68	0,8	2		SK1610	40	2-1445	2-1448	2-1446	2-1447
230 x 150 x 125	199 x 129 x 116	3,0	5	35	SK2311	20	2-1449	2-1452	2-1450	2-1451
350 x 210 x 145	299 x 186 x 134	7,5	15	90	SK3521	10	2-1453	2-1456	2-1454	2-1455
350 x 210 x 200	299 x 186 x 188	10,0	20	90	SK3522	10	2-1457	2-1460	2-1458	2-1459
500 x 313 x 145	447 x 281 x 132	17,0	30	180	SK5031	8	2-1461	2-1464	2-1462	2-1463
500 x 313 x 200	447 x 281 x 186	24,0	35	180	SK5032	6	2-1465	2-1468	2-1466	2-1467
500 x 310 x 200 (R)	447 x 281 x 186	24,0	50	180	SK5032R	6	2-1469			
500 x 313 x 300	448 x 282 x 286	36,0	35	150	SK5033	4	2-14896	2-14893	2-14895	2-14894



## Accessories



**A** Insertable windows - permanently attached to bin



**B** Dust covers



**C** Drop-on lids



**D** Longitudinal dividers

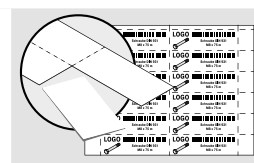

**E** Label sheets



**F** Label covers



**G** Handles

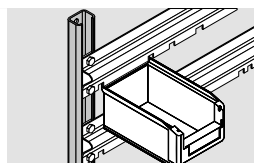

**H** Louvred panel uprights

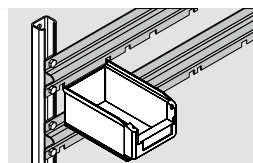

**I** Bin suspension rails

Pos.	Description		Accepts bin type	Pcs/pack	Ref. no.
<b>A</b>	Insertable windows - permanently attached to bin	made from transparent material, can be retro-fitted, mounted to bin to avoid loss, can also be opened when containers are stacked	SK 1610	10	2-1108
			SK 2311	10	2-1109
			SK 3521	10	2-1110
			SK 3522	10	2-1111
			SK 5031	10	2-11969
			SK 5032	10	2-1112
<b>B</b>	Dust covers	from plexiglass, dustproof storage, combined with the viewing window the bin is a completely closed unit	SK2311	10	2-1137
			SK3521, SK3522	10	2-1134
			SK5030, SK5031, SK5032	10	2-1136
<b>C</b>	Drop-on lids	from transparent polypropylene, optimum protection from dust, easy assembly, double function as dust cover and viewing window	SK 1095	10	2-19545
			SK 1610	10	2-19870
			SK 2311	10	2-30261
<b>D</b>	Longitudinal dividers	from polystyrene, colour: grey, can be retro-fitted, special holding fixture prevents labels from slipping out, effortless slot-in fixing	SK3521, SK3522	10	2-1074
			SK5032, SK5033	10	2-1075
<b>E</b>	Label sheets	pre-perforated blank label sheets, ready for direct printing, suited for laser and inkjet printers, on white DIN A4 sheets, 140 g/m <sup>2</sup> , 25 sheets per pack, colour white	SK1095	1600	46-20773
			SK1610	1000	46-20774
			SK2311, SK3521, SK3522	400	46-20775
			SK5031, SK5032	175	46-20776
			SK5033	125	46-20777
<b>F</b>	Label covers	made from transparent material, protect large-size labels from soiling and damage	SK1095	50	2-19547
			SK1610	50	2-1061
			SK2311, SK3521, SK3522	50	2-1063
			SK5031, SK5032	50	2-1066
			SK5033	50	2-14897
<b>G</b>	Handles	from black PVC, supplied ready-mounted upon request; for later-on assembly, bins must be prepared with drilled holes	SK5031, SK5032, SK5033	10	2-19527
<b>H</b>	Louvred panel uprights	galvanised steel profiles CW1 and CW2 for wall mounting, bin suspension rails can be adjusted in height anywhere along louvred panel uprights	L 1000 x W 35 x H 25 mm	1	8-5928
			L 2000 x W 35 x H 25 mm	1	8-5929
<b>I</b>	Bin suspension rails	profiled hanging rail from galvanised steel complete with 2 connector plates and 4 bolts. Notches will accommodate 10 bins SK1095, 10 bins SK1610, 7 bins SK2311, 5 bins SK3521. Louvred panel capacity and dimensions: number of hanging rails = number of bins in a row + 1, panel height = bin height + 45 mm, panel width = 1126 mm)	SK1095, SK1610, SK2311, SK3521	1	8-7869



### Louvered panel kits complete with bins

- Precision formed and finished in non-corrosive galvanised steel
- Easy wall mounting

STORAGE BINS WITH PICK OPENING

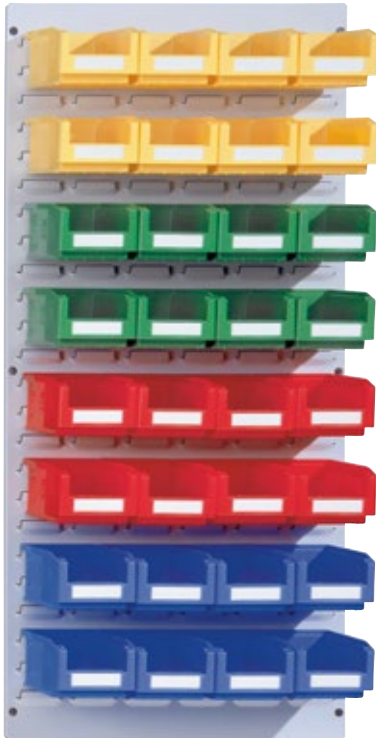

8-14902

8-14903

8-20089

8-20178

Dimensions W x H <i>mm</i>	Features	Ref. no.
457 x 495	16 x SK1610 (160 x 103 x 75 mm)	8-20178
	3 x SK2311 (230 x 150 x 125 mm)	8-14902
	8 x SK1610 (160 x 103 x 75 mm)	
457 x 991	32 x SK1610 (160 x 103 x 75 mm)	8-14903
	16 x SK1610 (160 x 103 x 75 mm)	8-20089
	9 x SK2311 (230 x 150 x 125 mm)	



## Louvered panels

suited for wall and workbench mounting

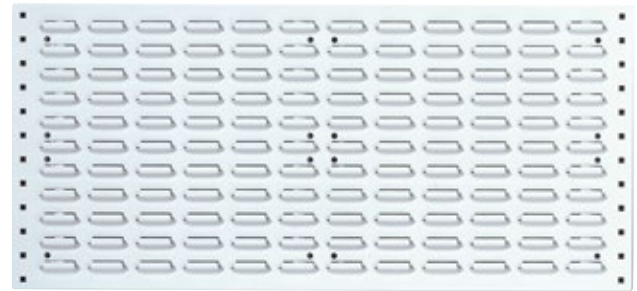

### Suited for wall and workbench mounting

- Reinforcing profiles on the rear, can also be fitted to a desktop
- Easy-to-mount, hardwearing steel sheet panels
- Designed to accommodate storage bins SK1095, SK1610 and SK2311

Width <i>mm</i>	Height <i>mm</i>	Ref. no.
495	457	8-14833
991	457	8-14834
1486	457	8-14835



STORAGE BINS WITH PICK OPENING

### Suited for wall mounting

- Easy-to-mount, hardwearing steel sheet panels
- Designed to accommodate storage bins SK1095, SK1610 and SK2311

Width <i>mm</i>	Height <i>mm</i>	Ref. no.
457	495	8-14837
	991	8-14838
	1486	8-14839

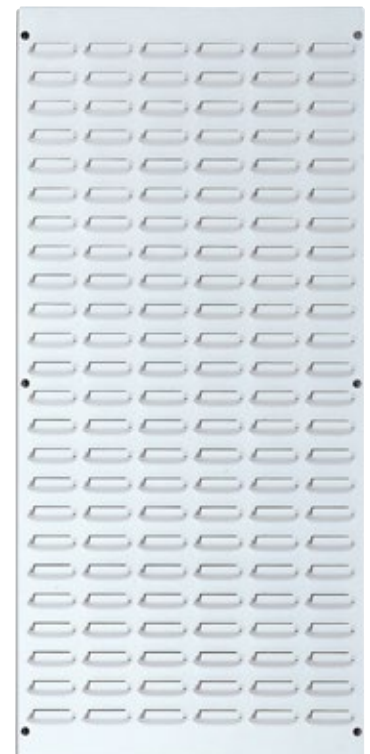

### Accessories



**A** Spigots for louvered panels

Pos.	Description	Dimensions <i>mm</i>	Pcs/pack	Ref. no.
<b>A</b>	Spigots for louvered panels, prong holder for louvered panels	L 150	1	8-14841
		L 200	1	8-14842
		L 300	1	8-14843

### Louvered panels

suited for rack mounting

- Easy-to-mount, hardwearing steel sheet panels
- Designed to accommodate storage bins SK1095, SK1610 and SK2311



Storage bins SK from page 22, 23

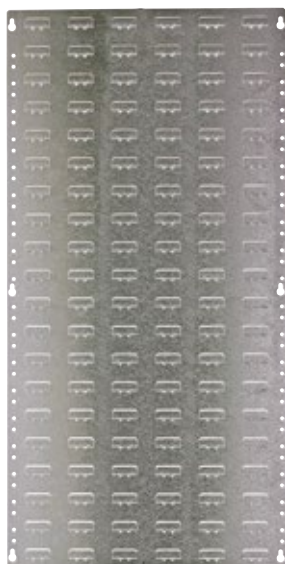

#### Fitted to shelving sides

For a shelving depth of <i>mm</i>	Height <i>mm</i>	Ref. no.
300	1000	8-31329
400	1000	8-31330
500	500	8-31333
	1000	8-31331
600	1000	8-31332
Fixing material	1 set contains 12 bolts M5 and 12 nuts for mounting a louvered panel to the shelving sides	
		8-56505

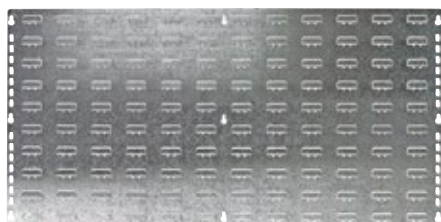

#### Fitted to shelving back

For a shelf length of <i>mm</i>	Height <i>mm</i>	Ref. no.
1000	500	8-31326
	1000	8-31327
1300	1000	8-31328
Fixing material	spring clips, please order 6/12 pcs. per louvered panel (500 mm/1000 mm high) to fix panel to shelving	
		10-12290

STORAGE BINS WITH PICK OPENING



## Bin racks and bin trolleys

Instant product identification, easy access!

### Bin trolleys

- Robust, welded steel construction, galvanised
- 1 push handle
- 2 swivel and 2 fixed castors, Ø 125 mm
- Easy self-assembly

Description	Dimensions H x W x D mm	Features	Ref. no.
single sided use	1705 x 1130 x 510	56 x SK2311 blue	8-19515
		40 x SK1610 red	8-13422
		21 x SK2311 blue	
		10 x SK3521 red	
		35 x SK3521 red	8-19516
		60 x SK1610 red 28 x SK2311 blue	8-19517
double sided use	1705 x 1130 x 710	120 x SK1610 red	8-19514
		112 x SK2311 blue	8-19520
		80 x SK1610 red	8-13423
		42 x SK2311 blue 20 x SK3521 red	
		70 x SK3521 red	8-19521
		120 x SK1610 red 56 x SK2311 blue	8-19522
		240 x SK1610 red	8-19519



### Bin racks

- Robust make
- Easy self-assembly
- Designed to accommodate several bin sizes for maximum use of space

Description	Dimensions H x W x D mm	Features	Ref. no.		
single sided use	1885 x 1130 x 500	70 x SK2311 blue	8-19501		
		60 x SK1610 red	8-19504		
		42 x SK2311 blue			
		50 x SK1095 blue 50 x SK1610 red 28 x SK2311 blue	8-19505		
		40 x SK1095 blue 40 x SK1610 red 21 x SK2311 blue 10 x SK3521 red	8-19503		
		40 x SK1610 red 21 x SK2311 blue 20 x SK3521 red	8-13420		
		45 x SK3521 red	8-19502		
		150 x SK1610 red	8-19500		
		double sided use	1885 x 1130 x 700	140 x SK2311 blue	8-19508
				100 x SK1095 blue 100 x SK1610 red 56 x SK2311 blue	8-19512
120 x SK1610 red 84 x SK2311 blue	8-19511				
80 x SK1095 blue 80 x SK1610 red 42 x SK2311 blue 20 x SK3521 red	8-19510				
80 x SK1610 red 42 x SK2311 blue 40 x SK3521 red	8-13421				
90 x SK3521 red	8-19509				
300 x SK1610 red	8-19507				



STORAGE BINS WITH PICK OPENING



### Boltless shelving complete with SK bins

galvanised finish

Perfect combination

- Shelf load: 70 kg
- Bay load: 500 kg
- Shelving complete with storage bins SK
- Shelves can be retro-fitted with a retaining lip at the rear
- Assembly with beams and cross bracing
- Fast and easy assembly without bolts saves time
- Extensions possible at any time
- Shelf levels adjustable in 25 mm increments
- All loads indicated refer to uniformly distributed loads

#### i BITO info

Bin colours as illustrated. Other colours (blue, red, green, yellow) upon request!

STORAGE BINS WITH PICK OPENING

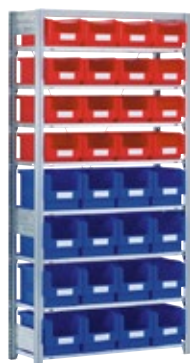

#### With 40 storage bins SK

Number of shelves	Features	Shelving type	Starter bay	Extension bay
		Dimensions H x W x D mm	Ref. no.	Ref. no.
10	40 x SK3521 (350 x 210 x 145 mm)	1850 x 900 x 324	12-53041	12-53042

#### With 32 storage bins SK

Number of shelves	Features	Shelving type	Starter bay	Extension bay
		Dimensions H x W x D mm	Ref. no.	Ref. no.
8	16 x SK3521 (350 x 210 x 145 mm) 16 x SK3522 (350 x 210 x 200 mm)	1850 x 900 x 324	12-53043	12-53044

#### With 30 storage bins SK

Number of shelves	Features	Shelving type	Starter bay	Extension bay
		Dimensions H x W x D mm	Ref. no.	Ref. no.
10	30 x SK5031 (500 x 315 x 145 mm)	1850 x 1000 x 524	12-53045	12-53046

#### With 28 storage bins SK

Number of shelves	Features	Shelving type	Starter bay	Extension bay
		Dimensions H x W x D mm	Ref. no.	Ref. no.
7	28 x SK3522 (350 x 210 x 200 mm)	1850 x 900 x 324	12-53047	12-53048

#### With 21 storage bins SK

Number of shelves	Features	Shelving type	Starter bay	Extension bay
		Dimensions H x W x D mm	Ref. no.	Ref. no.
7	21 x SK5032 (500 x 315 x 200 mm)	1850 x 1000 x 524	12-53049	12-53050



Cabinets with hinged doors 110°/180° and with bins from page 364



## Storage bins PK

Budget bin range with a large storage capacity and useful accessories

■ Good price-performance ratio

**BITOBOX** PK

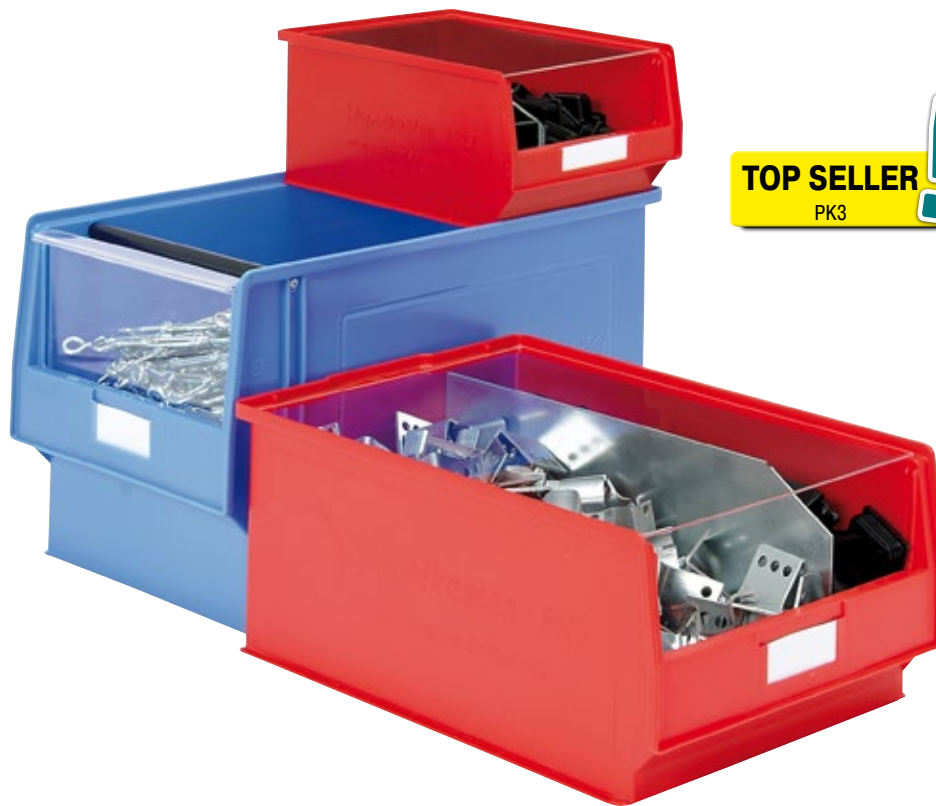

STORAGE BINS WITH PICK OPENING

External dimensions L x W x H	Internal dimensions L x W x H	Volume	Material	Bin type	Description	Pcs/pack	Ref. no.	Ref. no.
<i>mm</i>	<i>mm</i>	<i>litres</i>						
350 x 210 x 145	295 x 185 x 134	7,5	PP	PK3		10	2-1416	2-1419
350 x 210 x 200	295 x 185 x 190	10,0	PP	PK401		10	2-1427	2-1430
500 x 310 x 200	442 x 282 x 187	24,0	PP	PK2		6	2-1412	2-1415
500 x 310 x 300	438 x 280 x 293	38,0	PE	PK1	including handle	4	2-1410	2-1411

### Accessories



**A** Insertable windows



**B** Dust covers



**C** Handles

Pos.	Description	Accepts bin type	Product type	Pcs/pack	Ref. no.	
<b>A</b>	Insertable windows	push-fit viewing windows increase filling volume by up to 25%	PK1	ES1	10	2-1113
			PK2	ES2	10	2-1114
			PK3	ES3	10	2-1115
			PK401	ES401	10	2-1116
<b>B</b>	Dust covers	from plexiglass, drop-on fitting on storage bins to keep off dust	PK1, PK2	SD1	10	2-1124
			PK3, PK401	SD3	10	2-1135
<b>C</b>	Handles	for convenient container handling, easy bolt-on fixing, from black PVC	PK2	TS2	10	2-15849

### European size stacking containers XL

with view and pick opening

European size containers for storage, transport and order picking

- Large volume
- Ergonomic through-grips improve handling convenience
- Supplied with 1 label card per container
- Label holder on all four sides
- Pick opening with window from indestructible polycarbonate (see accessories)

**BITOBOX XL**



**i** [www.mybitobox.com](http://www.mybitobox.com)

Configure colours and logos online!

#### BITO-Plus

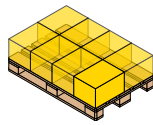
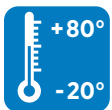

400 x 300 mm

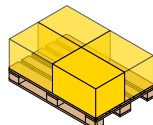

600 x 400 mm

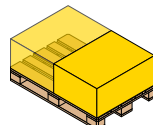

800 x 600 mm



#### With short side pick opening

External dimensions L x W	Height	Internal dimensions L x W x H	Pick opening W x H	Volume	Load capacity	Stacking load	Bin type	Ref. no.	Ref. no.
mm	mm	mm	mm	litres	kg	kg			
400 x 300	170	368 x 268 x 167	212 x 81	15,0	15	200	XL43174	43-14979	43-14980
	220	368 x 268 x 217	212 x 106	19,0	20	200	XL43224	43-14981	43-14982
	270	368 x 268 x 267	212 x 131	24,0	20	200	XL43274	43-14983	43-14984
600 x 400	170	568 x 368 x 166	274 x 81	31,0	15	250	XL64174	43-14985	43-14986
	220	568 x 368 x 216	274 x 106	41,0	15	250	XL64224	43-14987	43-14988
	270	568 x 368 x 266	274 x 131	51,0	15	250	XL64274	43-14989	43-14990
	320	568 x 368 x 316	274 x 156	62,0	20	250	XL64324	43-14991	43-14992
	420	568 x 368 x 416	274 x 206	82,0	20	250	XL64424	43-14993	43-14994
800 x 600	220	762 x 562 x 215	459 x 103	86,0	60	500	XL86224		43-22598
	320	762 x 562 x 315	459 x 153	128,0	60	500	XL86324		43-22613
	420	762 x 562 x 415	459 x 203	170,0	60	500	XL86424		43-22560
	520	762 x 562 x 515	459 x 253	213,0	60	500	XL86524		43-22575

#### With long side pick opening

- Long side pick opening ensures fast and easy retrieval

External dimensions L x W	Height	Internal dimensions L x W x H	Pick opening W x H	Volume	Load capacity	Stacking load	Bin type	Ref. no.
mm	mm	mm	mm	litres	kg	kg		
800 x 600	320	762 x 562 x 315	459 x 153	128,0	60	800	XL86326	43-22614
	420	762 x 562 x 415	459 x 203	170,0	60	800	XL86426	43-22625
	520	762 x 562 x 515	459 x 253	213,0	60	800	XL86526	43-22576



STORAGE BINS WITH PICK OPENING

## Accessories



**A** Insertable windows - permanently attached to bin



**B** Drop-on lids



**C** Drop-on lid

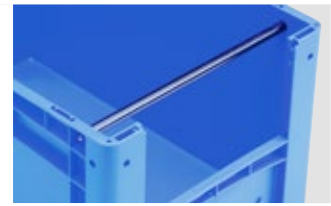

**D** Handles

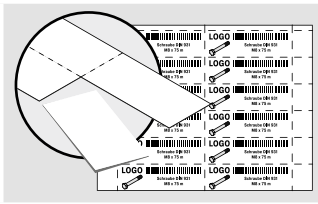

**E** Label sheets



**F** Labels



**G** Transport dollies



**H** Transport dollies

Pos.	Description	Colour	Accepts bin type	Product type	Pcs/pack	Ref. no.	
<b>A</b>	Insertable windows - permanently attached to bin	provides protection against dust, made from polycarbonate to allow instant product viewing, easy product retrieval, mounted to bin to avoid loss, can also be opened when containers are stacked	transparent	XL43174	ES43174XL	10	43-22536
				XL43224	ES43224XL	10	43-18584
				XL43274	ES43274XL	10	43-18585
				XL64224	ES64224XL	10	43-18589
				XL64274	ES64274XL	10	43-18588
				XL64324	ES64324XL	10	43-18587
				XL64424	ES64424XL	10	43-18586
				XL86324/6	ES8632XL	10	43-20271
				XL86424/6	ES8642XL	10	43-22548
<b>B</b>	Drop-on lids	will cover container stacks, can also be used to close individual containers, suited for automated lidding and strap-sealing	blue	L 400 x W 300 mm	AD43	1	43-20303
			red	L 400 x W 300 mm	AD43	1	43-20498
			blue	L 600 x W 400 mm	AD64	1	43-20301
			red	L 600 x W 400 mm	AD64	1	43-20494
<b>C</b>	Drop-on lid	will cover container stacks, can also be used to close individual containers	grey	L 800 x W 600 mm	SLS86-46	1	52-30500
<b>D</b>	Handles	for convenient container handling, easy bolt-on fixing, can be retro-fitted, for short side pick openings only	black	400 x 300 mm	TS43XL	10	43-9409
				600 x 400 mm	TS64XL	10	43-9408
				800 x 600 mm	TS86XL	10	43-22624
<b>E</b>	Label sheets	pre-perforated blank label sheets, ready for direct printing, suited for laser and inkjet printers, on white DIN A4 sheets, 140 g/m <sup>2</sup> , 25 sheets per pack, colour white	white	W 210 x H 74 mm	46-20778	100	46-20778
<b>F</b>	Label covers	angled upper edge allows easy label inserting from the top, suited for all XL and KLT containers	water clear	KLT	KLT-ET1	10	9-20053
	Labels	white card labels, suited for all XL and KLT containers with a minimum height of 170 mm	white	W 210 x H 74 mm	XL21/74	50	43-14557
<b>G</b>	Transport dollies	complete with 4 swivel castors, designed for European size stacking containers: 1 x 600 x 400 mm or 2 x 400 x 300 mm, framework from glassfibre reinforced polyamide	RAL 5007 Brilliant blue	L 620 x W 420 mm	TR64	1	43-1491
				L 620 x W 420 mm	TR64G	1	43-21883
<b>H</b>	Transport dollies	supplied with 2 swivel and 2 fixed castors, suited for containers sized 800 x 600 mm, made from polypropylene	anthracite grey	L 800 x W 600 x H 198 mm	RU86.125	1	43-1150





### European size stacking containers BN

with view and pick opening

Extremely sturdy range with European footprint

- View and pick opening available on short side or on long side
- Ergonomic through-grips improve handling convenience
- Optional transparent plastic window available
- Carry / safety handle from black PVC (see accessories) - for short side pick opening only
- Label covers (see accessories)
- For loads of up to 50 kg
- Colour: blue

**TOP SELLER!**

BN4314



**BITOBOX BN**

#### BITO-Plus

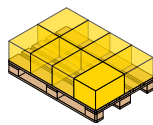

400 x 300 mm

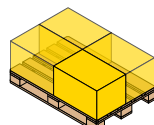

600 x 400 mm



#### With short side pick opening

External dimensions L x W	Height	Internal dimensions L x W x H	Pick opening W x H	Volume	Load capacity	Stacking load	Bin type	Ref. no.
mm	mm	mm	mm	litres	kg	kg		
400 x 300	153	360 x 260 x 150	230 x 85	14	30	150	BN4314	4-1616
	215	360 x 260 x 211	230 x 117	20	40	150	BN4324	4-1288
	265	360 x 260 x 261	230 x 117	24	50	150	BN43264	4-1289
600 x 400	215	560 x 360 x 211	310 x 117	42	40	250	BN6424	4-1290
	315	560 x 360 x 311	310 x 155	62	50	250	BN6434	4-1286
	415	560 x 360 x 411	310 x 200	82	50	250	BN6444	4-1287



#### With long side pick opening

External dimensions L x W	Height	Internal dimensions L x W x H	Pick opening W x H	Volume	Load capacity	Stacking load	Bin type	Ref. no.
mm	mm	mm	mm	litres	kg	kg		
600 x 400	315	560 x 360 x 311	430 x 200	62	40	250	BN6436	4-1617
	415	560 x 360 x 411	430 x 230	82	40	250	BN6446	4-1618



## Accessories



**A** Insertable windows - permanently attached to bin

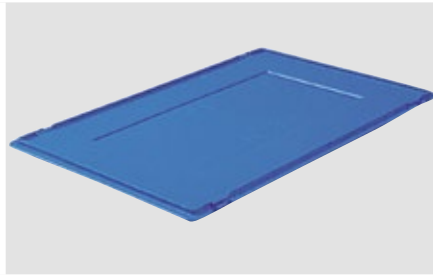

**B** Drop-on lids

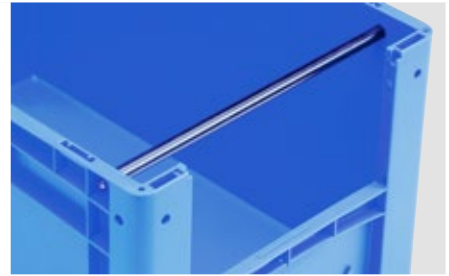

**C** Handles



**D** Label covers



**E** Hinge clips for lids



STORAGE BINS WITH PICK OPENING

Pos.	Description		Colour	Accepts bin type	Product type	Pcs/pack	Ref. no.
<b>A</b>	Insertable windows - permanently attached to bin	provides protection against dust, made from plexiglass to allow instant product viewing - easy product retrieval, mounted to bin to avoid loss, can also be opened when containers are stacked	transparent	BN43264	ES432	10	4-11716
				BN6424	ES6424	10	4-10885
				BN6434	ES6434	10	4-1147
				BN6436	ES6436	10	4-11703
				BN6444	ES6444	10	4-1148
				BN6446	ES6446	10	4-11917
<b>B</b>	Drop-on lids	reliable protection against soiling, excellent stacking capacity also applies for lidded containers	blue	L 400 x W 300 mm	KD430	1	4-1152
				L 600 x W 400 mm	KD640	1	4-1153
<b>C</b>	Handles	for convenient container handling, easy bolt-on fixing, can be retro-fitted, for short side pick openings only	black	400 x 300 mm	TS43XL	10	43-9409
				600 x 400 mm	TS64XL	10	43-9408
<b>D</b>	Label covers	can be retro-fitted, for 95 mm and 68 mm wide labels	water clear	except BD4314, BN6407	ET5	10	4-9454
<b>E</b>	Hinge clips for lids	easy clip-on fitting of lid to container, from white PVC, push-in fitting, 2 hinge clips = lid swings open, 4 hinge clips = lid is closed	white		DSV	100	4-1144

## Pick walls - ready-to-use setups consisting of stacking containers

- Ideal for creating storage and picking areas with minimal effort
- Lightweight, can be relocated in seconds
- Easy to expand and adjust



### Container Pick Walls with small XL containers, with short side pick opening, 400 mm deep

External dimensions W x H x D <i>mm</i>	Features	Individual container dimensions W x H x D <i>mm</i>	Colour	Ref. no.
1200 x 810 x 400	12 x XL43274	400 x 300 x 270	blue	43-36105
1200 x 850 x 400	20 x XL43174	400 x 300 x 170	blue	43-36107
1200 x 880 x 400	16 x XL43224	400 x 300 x 220	blue	43-36106



### Container Pick Walls with medium XL containers, with short side pick opening, 600 mm deep

External dimensions W x H x D <i>mm</i>	Features	Individual container dimensions W x H x D <i>mm</i>	Colour	Ref. no.
1600 x 1600 x 600	20 x XL64324	600 x 400 x 320	blue	43-41967
1600 x 1620 x 600	24 x XL64274	600 x 400 x 270	blue	43-41966
1600 x 1760 x 600	16 x XL64424	600 x 400 x 420	blue	43-41969
1600 x 1760 x 600	32 x XL64224	600 x 400 x 220	blue	43-41965



### Pick walls with BN containers 600 x 400 mm, with long side pick opening, 400 mm deep

External dimensions W x H x D <i>mm</i>	Features	Individual container dimensions W x H x D <i>mm</i>	Colour	Ref. no.
2400 x 1640 x 400	16 x BN6446	600 x 400 x 415	blue	43-36108
2400 x 1890 x 400	24 x BN6436	600 x 400 x 315	blue	43-41963



## Container Pick Walls with large XL containers, with short side pick opening, 800 mm deep

External dimensions W x H x D <i>mm</i>	Features	Individual container dimensions W x H x D <i>mm</i>	Colour	Ref. no.
2400 x 1560 x 800	9 x XL86524	800 x 600 x 520	blue	43-41975
2400 x 1600 x 800	15 x XL86324	800 x 600 x 320	blue	43-41971
2400 x 1680 x 800	12 x XL86424	800 x 600 x 420	blue	43-41973



## Container Pick Walls with large XL containers, with long side pick opening, 600 mm deep

External dimensions W x H x D <i>mm</i>	Features	Individual container dimensions W x H x D <i>mm</i>	Colour	Ref. no.
2400 x 1600 x 600	15 x XL86326	800 x 600 x 320	blue	43-41972
2400 x 1680 x 600	12 x XL86426	800 x 600 x 420	blue	43-41974
2400 x 2080 x 600	9 x XL86526	800 x 600 x 520	blue	43-41976



## Heavy Duty Pick Walls with SL containers

External dimensions W x H x D <i>mm</i>	Features	Individual container dimensions W x H x D <i>mm</i>	Colour	Description	Ref. no.
1800 x 2140 x 800	9 x SL86624K	800 x 600 x 620	grey	with half-drop door on the short side	43-36147
	9 x SL86624K	800 x 600 x 620	grey	with short side pick opening	43-36144
2400 x 1540 x 600	9 x SL86426K	800 x 600 x 420	grey	with half-drop door on the long side	43-36148
	9 x SL86426K	800 x 600 x 420	grey	with long side pick opening	43-36145
2400 x 2140 x 600	9 x SL86626K	800 x 600 x 420	grey	with half-drop door on the long side	43-41964
	9 x SL86626K	800 x 600 x 620	grey	with long side pick opening	43-36143



## C-item bins CTB

### Streamline your workflow with C-item bins!

C-item CTB bins combine the advantages of handling bins with all sides closed and storage bins with pick opening. On top of this, CTB bins come in sizes that have been adapted to standard shelving dimensions.

All bins are supplied with a slide-down window as standard feature. The curved lip serves as carrying handle and as push & pull grip. The bin base is conveniently radiused for easy retrieval even of very small items. Optional extras such as product feeder panels, a safety bar and cross dividers improve handling convenience.

**i** [www.mybitobox.com](http://www.mybitobox.com)  
Configure colours and logos online!

SMALL PARTS STORAGE

### BITOBOX CTB



**Slide-down window**  
The integral handle unites several functions: it can be used to carry bins, to push and pull bins stored in racks and it provides a large label area.



**Front picking**  
By simply pushing down the window smaller quantities can be retrieved without having to pull the bin forward.



**Top picking**  
For retrieving larger quantities, the bin can be pulled forward and tilted; the carrying handle lifts automatically, preventing the bin from falling out and lowers when the bin is pushed back into the rack.



**Slide-down window CSS**  
Prevents small items from spilling out when the bin is tilted or the slide-down window is pushed down.





## C-item bins CTB

from sunflower compound (SFC), grey

### Sunflower-Compound (SFC)

#### i BITO info

BITO C-item bins CTB - so far made from polypropylene - can also be manufactured from environmentally friendly sunflower compound (SFC). This new material is a mixture of polypropylene and fibres from sunflower seed shells, a previously unused waste product from the food industry



SMALL PARTS STORAGE

... made from resource-saving material!

- Opting for bins from sunflower compound means reducing your carbon footprint and saving energy
- The containers are manufactured from sunflower plastic compound that combines traditional polymers with an environmentally friendly by-product of the food industry

**BITO-Plus**



### From sunflower compound (SFC), grey

External dimensions L x W x H	Internal dimensions L x W x H	Volume	Load capacity	Stacking load	Bin type	Pcs/pack	Ref. no.
mm	mm	litres	kg	kg			
300 x 156 x 140	250 x 127 x 129	4.1	15	100	CTB31514SFC	12	C0240-0005
400 x 156 x 140	350 x 127 x 129	5.7	15	100	CTB41514SFC	12	C0240-0006



### C-item bins CTB

polypropylene (PP), dove blue

C-item bins – extremely robust, versatile and unmistakably BITO!

- Simply push down the window for picking smaller quantities without having to pull the bin forward
- Optional product feeder panel to prevent items from spilling out
- The container base is conveniently radiused for easy retrieval even of very small items
- Label holder on the back of the bin to accommodate Kanban cards
- Supplied with slide-down window as standard feature. The window with integral handle can also be used to carry bins, to push and pull bins stored in racks and it provides a large label area.

#### BITO-Plus

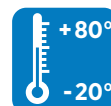

**i** [www.mybitobox.com](http://www.mybitobox.com)

Configure colours and logos online!

**TOP SELLER!**

CTB31514



### Polypropylene (PP), dove blue

External dimensions L x W x H	Internal dimensions L x W x H	Volume	Load capacity	Stacking load	Bin type	Pcs/pack	Ref. no.
<i>mm</i>	<i>mm</i>	<i>litres</i>	<i>kg</i>	<i>kg</i>			
300 x 156 x 140	250 x 127 x 129	4.1	15	100	CTB31514	12	53-31315
400 x 156 x 140	350 x 127 x 129	5.7	15	100	CTB41514	12	53-31316



SMALL PARTS STORAGE

## Accessories



**A** Product feeder panels CDS



**B** Carry/safety handle



**C** Cross dividers CQT



**D** Easy peel label holders

Pos.	Description	Accepts bin type	Pcs/pack	Ref. no.
<b>A</b>	Product feeder panels CDS prevent small items from spilling out when bin the is tilted or the slide-down window is pushed down	CTB31514/ CTB41514	10	53-31304
<b>B</b>	Carry/safety handle spring-mounted safety and carry handle, can be retro-fitted at any time, the optional rear handle securely locks the bin to the shelving as soon as the bin is tilted forward; when the bin is removed from the shelving, the handle makes for easy and safe carrying, prevent bins from being pulled out of the shelving by accident, lowers automatically when bin is pushed into shelving or when weight is applied during stacking	RK*1509, CTB*1514	10	3-31314
<b>C</b>	Cross dividers CQT allows to implement the kanban principle in the same bin by dividing a quantity of same storage items into 2 lots	CTB31514/ CTB41514	10	53-31303
<b>D</b>	Easy peel label holders self-adhesive carrier foil for easy removal of stick-on labels from bin and container surfaces		100	53-31308
<b>E</b>	Dust covers CSD dustproof storage, from transparent material	CTB31514 CTB41514	10 10	53-31341 53-31342

## Kanban bin shelving for small parts

with bins, galvanised finish

Save space and time with the new BITO Kanban solution

- **Shelf load: 150 kg**
- **Bay load: 1250 kg**
- **Ideal for storing C-items**
- **Ultra flat shelves are real space savers**
- **Stores 25% more C-items and provides ergonomic access for order pickers**
- **All bins are supplied with a slide-down window as standard feature. For optional extras such as product feeder panels, cross dividers, safety bars and dust covers refer to CTB bin accessories.**
- **Shelves can be retro-fitted with a retaining lip at the rear**
- **All loads indicated refer to uniformly distributed loads**



Scan this QR code:

**Insertable bins**

[www.bitto.com/web-kltek-de](http://www.bitto.com/web-kltek-de)



Width of starter bay  
1058 mm



Width of extension bay  
1008 mm



Top picking



Front picking

Shelving height <i>mm</i>	Number of shelves	Description	External bay depth <i>mm</i>	Useable depth <i>mm</i>	Features	Shelf width	1000 mm	
						Shelving type	Starter bay	Extension bay
						Bay load	Ref. no.	Ref. no.
						<i>kg</i>		
1850	10	single sided use	324	300	60 x CTB31514 (300 x 156 x 140 mm)	1250	10-53005	10-53008
			424	400	60 x CTB41514 (400 x 156 x 140 mm)			10-53009
		double sided use	624	600	120 x CTB31514 (300 x 156 x 140 mm)			10-53007

### Accessories



**A** Additional shelves



Boltless shelving accessories from page 168

Pos.	Description		Load capacity <i>kg</i>	For a shelf length of <i>mm</i>	For a shelving depth of <i>mm</i>	Pcs/pack	Ref. no.
<b>A</b>	Shelf, 25 mm high	shelf height 25 mm, with shelf perforations for dividers, ultra flat shelves help you make the most of your storage space, all loads indicated refer to uniformly distributed loads	150	1000	300	1	10-C1165-0008
					400	1	10-C1165-0011
					600	1	10-C1165-0017

## Storage and handling bins PK

Sloped bin front for immediate product identification

- Budget alternative to storage and handling bins RK
- Supplied with labels and label covers
- Optionally available as transparent version

**BITOBOX PK**

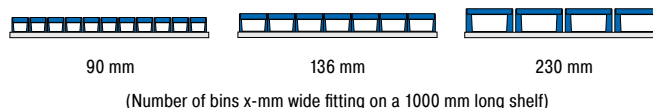
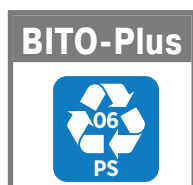
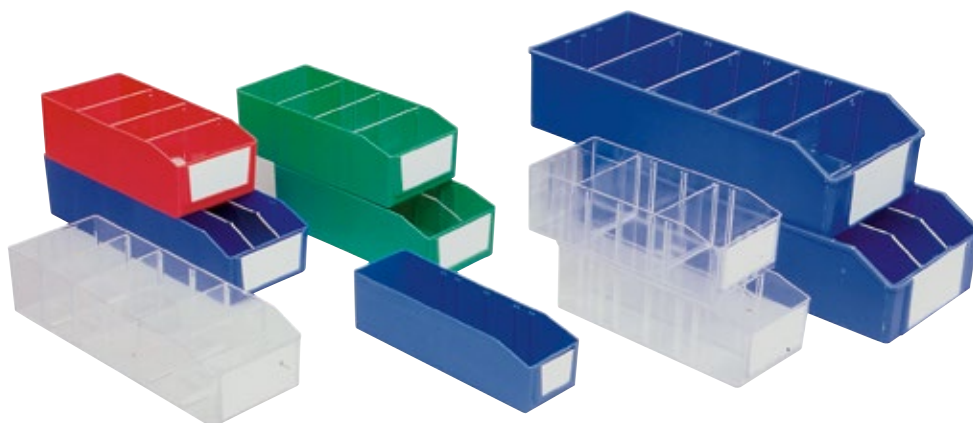

Length	Width	Height	Internal dimensions L x W x H	Volume	Bin type	Pcs/pack	Colour	Ref. no.
mm	mm	mm	mm	litres				
295	90	80	283 x 81 x 77	1.8	PK3091	35	blue	3-1421
	90	80	283 x 81 x 77	1.8	PK3090	35	water clear	3-1420
	136	90	283 x 125 x 87	3.1	PK3131	14	blue	3-1423
	136	90	283 x 125 x 87	3.1	PK3131	14	red	3-1425
	136	90	283 x 125 x 87	3.1	PK3131	14	green	3-1424
	136	90	283 x 125 x 87	3.1	PK3130	14	water clear	3-1422
395	136	90	381 x 125 x 87	4.2	PK4131	14	blue	3-1432
	136	90	381 x 125 x 87	4.2	PK4130	14	water clear	3-1431
500	230	115	486 x 210 x 111	9.2	PK351	14	blue	3-1426

### Accessories

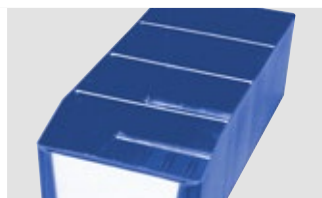
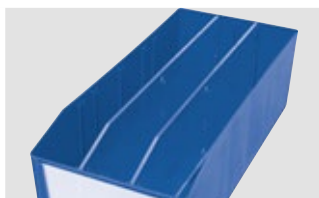

**A** Longitudinal dividers

**B** Cross dividers

Pos.	Description	Colour	Accepts bin type	Pcs/pack	Ref. no.	
<b>A</b>	Longitudinal dividers	subdivide bins front-to-back into two or three compartments	water clear	PK3130, PK3131	10	3-1073
			galvanised	PK351	10	3-1091
				PK4130, PK4131	10	3-1092
<b>B</b>	Cross dividers	dovetail grooves safely hold dividers in place	transparent	PK3130, PK3131, PK4130, PK4131	10	3-1099
				PK351	10	3-1102
				PK3090, PK3091	10	3-1097



### Storage and handling bins RK

## Keep everything in the right place!

Designed to fit perfectly into BITO shelving, the storage and handling bin series RK is ideal for storing small items. The large storage volume, high rigidity and numerous accessories are further benefits. External hand grips and an optional support bar at the rear ensure convenient handling.

### BITOBOX RK



SMALL PARTS STORAGE

### Product features



**Handling**  
The handle and the integral grip allow excellent manual handling. 90° corners, snag-free internal sides and a flat base allow excellent volume utilisation.



**Support bar**  
Retro-fitting the support bar for shelf use turns the bin into a drawer and prevents it from being pulled out by accident.



**Stacking safety**  
Stacking safety is excellent due to the slightly prominent base edging and stacking rim on all sides and does not reduce with use of the lid and lifting/safety bar. Very high load capacity and stacking load.



## Storage and handling bins RK

Ideal for storing small items in a minimum of space and away from dust and dirt

- Fit perfectly into BITO shelving systems
- Comfortable and safe handling improves operational efficiency
- Excellent volume utilisation
- Excellent rigidity – safe stacking
- Broad range of accessories
- Supplied with 1 label card per container
- Colour: dove blue

**TOP SELLER!**  
RK3109



**BITO-Plus**

supplied in any colour for orders exceeding 200 pcs.

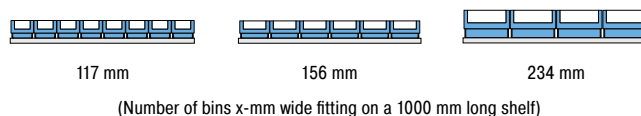

Width	Height	Length	Volume	Load capacity	Stacking load	Internal dimensions L x W x H	Bin type	Pcs/pack	Ref. no.
mm	mm	mm	litres	kg	kg	mm			
117	80	400	2.5	3	9	360 x 95 x 70	RK4108	16	3-19146
	90	300	2.0	2	6	260 x 94 x 80	RK3109	16	3-1433
	90	400	2.7	3	9	360 x 94 x 80	RK4109	16	3-1436
	90	500	3.5	4	12	460 x 94 x 80	RK5109	16	3-1439
	90	600	4.0	5	15	560 x 94 x 80	RK6109	16	3-1442
156	90	300	2.7	3	7	258 x 136 x 80	RK31509	12	3-22677
	90	400	3.8	4	8	358 x 136 x 80	RK41509	12	3-22678
	90	500	4.9	5	15	456 x 133 x 80	RK51509	12	3-22693
	90	600	6.0	6	18	556 x 133 x 80	RK61509	12	3-22695
234	80	400	5.3	6	20	356 x 214 x 70	RK4208	8	3-19145
	90	300	4.4	5	15	256 x 211 x 80	RK3209	8	3-1434
	90	400	6.0	6	20	356 x 211 x 80	RK4209	8	3-1437
	90	500	7.8	8	25	456 x 211 x 80	RK5209	8	3-1440
	90	600	9.4	10	30	556 x 211 x 80	RK6209	8	3-1443
	140	300	7.1	7	20	253 x 210 x 129	RK3214	6	3-1435
	140	400	9.9	10	30	353 x 210 x 129	RK4214	6	3-1438
	140	500	12.0	13	40	453 x 210 x 129	RK5214	6	3-1441
	140	600	15.0	15	45	553 x 210 x 129	RK6214	6	3-1444

**Storage and handling bins RK**

**Accessories**



**A** Cross dividers

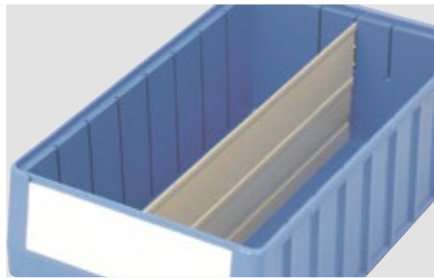

**B** Longitudinal dividers



**C** Carry/safety handle

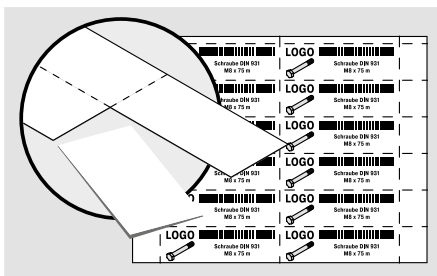

**D** Label sheets



**E** Label covers



**F** Dust covers



SMALL PARTS STORAGE



Pos.	Description	Accepts bin type	Product type	Pcs/pack	Ref. no.
A	Cross dividers from transparent material, label area adapted to size of computer printable labels, adjustable on a 44 mm pitch, dividers safely slot into dovetail grooves, radiused base for ease of component retrieval, even of very small items, supplied with label cards	RK*108	QT108	10	3-19148
		RK*109	QT109	10	3-1588
		RK*208	QT208	10	3-19147
		RK*209	QT209	10	3-1590
		RK*214	QT214	10	3-1591
		RK*1509	QT1509	10	3-22676
B	Longitudinal dividers solid longitudinal sheet divider, with grey beige coating, subdivide bins front-to-back into two or three compartments	RK3209/RK31509	LT3209	10	3-1077
		RK3214	LT3214	10	3-1078
		RK4208	LT4208	10	3-19066
		RK4209	LT4209	10	3-1079
		RK4214	LT4214	10	3-1080
		RK5209	LT5209	10	3-1081
		RK5214	LT5214	10	3-1082
		RK6209	LT6209	10	3-1083
		RK6214	LT6214	10	3-1084
		RK51509	LT51509	10	3-29370
C	Carry/safety handle spring-mounted safety and carry handle, can be retro-fitted at any time, the optional rear handle securely locks the bin to the shelving as soon as the bin is tilted forward; when the bin is removed from the shelving, the handle makes for easy and safe carrying, prevent bins from being pulled out of the shelving by accident, lowers automatically when bin is pushed into shelving or when weight is applied during stacking	RK*109	TSB1	10	3-1514
		RK*209, 214	TSB2	10	3-1515
		RK*1509, CTB*1514	TSB3	10	3-31314
D	Label sheets pre-perforated blank label sheets, ready for direct printing, suited for laser and inkjet printers, on white DIN A4 sheets, 140 g/m <sup>2</sup> , 25 sheets per pack, colour white	QT108, QT109	46-20766	675	46-20766
		QT1509, QT208, QT209, QT214	46-20775	400	46-20775
		RK*108	46-20767	450	46-20767
		RK*109	46-20768	375	46-20768
		RK*208	46-20770	225	46-20770
		RK*209	46-20771	175	46-20771
		RK*214	46-20772	100	46-20772
		RK*1509	46-20769	250	46-20769
E	Label covers made from transparent material, protect large-size labels from soiling and damage	RK*108	SF108	50	3-19140
		RK*109	SF109	50	3-1062
		RK*208	SF208	50	3-19142
		RK*209	SF209	50	3-1067
		RK*214	SF214	50	3-1068
		RK*1509	SF1509	50	3-22681
F	Dust covers from plexiglass, with hand hole	RK3109	SD31	10	3-1126
		RK3209, RK3214	SD32	10	3-1127
		RK4109	SD41	10	3-1128
		RK4208, RK4209, RK4214	SD42	10	3-1129
		RK5109	SD51	10	3-1130
		RK5209, RK5214	SD52	10	3-1131
		RK6109	SD61	10	3-1132
		RK6209, RK6214	SD62	10	3-1133
		RK31509	SD315	10	3-30200
		RK41509	SD415	10	3-30201
		RK51509	SD515	10	3-30202
		RK61509	SD615	10	3-30203





## Boltless shelving complete with RK bins

galvanised finish

Large number of sizes to meet all needs

- Shelf load: 70 kg
- Bay load: 500 kg
- Shelving complete with storage and handling bins RK
- Bin colour: dove blue
- Shelves can be retro-fitted with a retaining lip at the rear
- Assembly with beams and cross bracing
- Fast and easy assembly without bolts saves time
- Extensions possible at any time
- Shelf levels adjustable in 25 mm increments
- All loads indicated refer to uniformly distributed loads

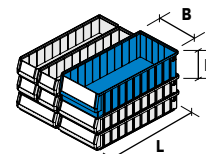

Storage and handling bins RK



Storage and handling bins RK on page 43, 45

SMALL PARTS STORAGE



### With 64 storage and handling bins RK (3 sizes)

Number of shelves	Features	Shelving type	Starter bay	Extension bay
		Dimensions H x W x D mm	Ref. no.	Ref. no.
12	32 x RK3109 (300 x 117 x 90 mm) 16 x RK3209 (300 x 234 x 90 mm) 16 x RK3214 (300 x 234 x 140 mm)	1850 x 1000 x 324	12-53011	12-53012
	32 x RK4109 (400 x 117 x 90 mm) 16 x RK4209 (400 x 234 x 90 mm) 16 x RK4214 (400 x 234 x 140 mm)	1850 x 1000 x 424	12-53013	12-53014
	32 x RK5109 (500 x 117 x 90 mm) 16 x RK5209 (500 x 234 x 90 mm) 16 x RK5214 (500 x 234 x 140 mm)	1850 x 1000 x 524	12-53015	12-53016
12	32 x RK6109 (600 x 117 x 90 mm) 16 x RK6209 (600 x 234 x 90 mm) 16 x RK6214 (600 x 234 x 140 mm)	1850 x 1000 x 624	12-21510	12-21511

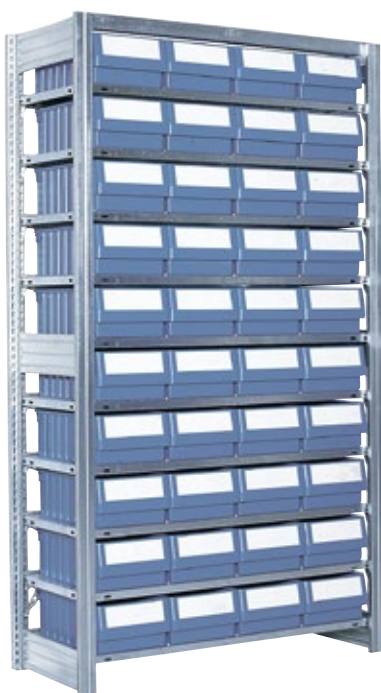

### With 40 storage and handling bins RK

Number of shelves	Features	Shelving type	Starter bay	Extension bay
		Dimensions H x W x D mm	Ref. no.	Ref. no.
10	40 x RK3214 (300 x 234 x 140 mm)	1850 x 1000 x 324	12-53017	12-53018
	40 x RK4214 (400 x 234 x 140 mm)	1850 x 1000 x 424	12-53019	12-53020
	40 x RK5214 (500 x 234 x 140 mm)	1850 x 1000 x 524	12-53021	12-53022
	40 x RK6214 (600 x 234 x 140 mm)	1850 x 1000 x 624	12-53023	12-53024

## With 56 storage and handling bins RK

Number of shelves	Features	Shelving type	Starter bay	Extension bay
		Dimensions H x W x D mm	Ref. no.	Ref. no.
14	56 x RK3209 (300 x 234 x 90 mm)	1850 x 1000 x 324	12-53025	12-53026
	56 x RK4209 (400 x 234 x 90 mm)	1850 x 1000 x 424	12-53027	12-53028
	56 x RK5209 (500 x 234 x 90 mm)	1850 x 1000 x 524	12-53029	12-53030
	56 x RK6209 (600 x 234 x 90 mm)	1850 x 1000 x 624	12-53031	12-53032

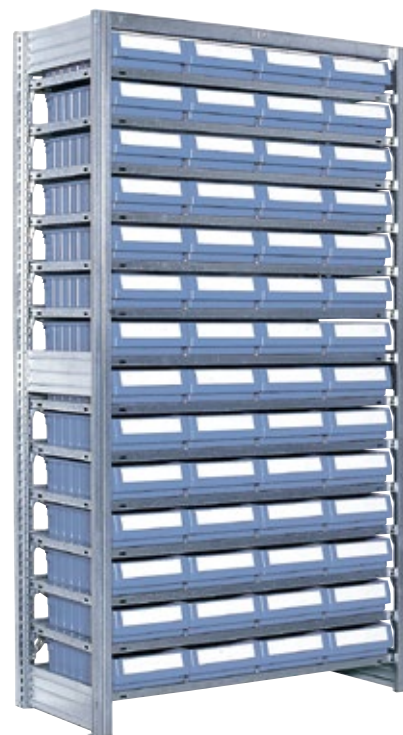

## With 112 storage and handling bins RK

Number of shelves	Features	Shelving type	Starter bay	Extension bay
		Dimensions H x W x D mm	Ref. no.	Ref. no.
14	112 x RK3109 (300 x 117 x 90 mm)	1850 x 1000 x 324	12-53033	12-53034
	112 x RK4109 (400 x 117 x 90 mm)	1850 x 1000 x 424	12-53035	12-53036
	112 x RK5109 (500 x 117 x 90 mm)	1850 x 1000 x 524	12-53037	12-53038
	112 x RK6109 (600 x 117 x 90 mm)	1850 x 1000 x 624	12-53039	12-53040



SMALL PARTS STORAGE

## Accessories



A Shelf ledges

Pos.	Description		For a shelf length of mm	Ref. no.
A	Shelf ledges	for 25 mm high shelves, to be inserted between shelf and shelf clips, prevent goods from slipping off the shelf, galvanised	1000	10-52182



### Tilt-open container modules

Dustproof storage = clean products and easy inventory control

- **Scratch-resistant and extremely durable**
- **Bins can be tilted forward from housing and can also be removed for easy filling**
- **Modules can be stacked or mounted on a louvered panel**
- **Solid design for a long service life**
- **Supplied with label cards**

SMALL PARTS STORAGE



### Tilt-open container modules



External dimensions W x H x D	Number of containers	Features	Ref. no.	Ref. no.
<i>mm</i>				
600 x 77 x 62	9	Klaka Set 9	7-14882	7-22607
600 x 113 x 91	6	Klaka Set 6	7-14880	7-22608
600 x 164 x 133	5	Klaka Set 5	7-14878	7-22609
600 x 207 x 168	4	Klaka Set 4	7-14876	7-22610
600 x 240 x 197	3	Klaka Set 3	7-14874	7-22611
600 x 353 x 299	2	Klaka Set 2	7-14872	7-22612

### Individual containers for tilt-open container modules



External dimensions W x H x D	Number of containers	Features	Colour	Ref. no.
<i>mm</i>				
60 x 66 x 56	20	for Klaka Set 9	water clear	7-14883
93 x 100 x 84	20	for Klaka Set 6	water clear	7-14881
113 x 152 x 129	18	for Klaka Set 5	water clear	7-14879
142 x 190 x 165	8	for Klaka Set 4	water clear	7-14877
192 x 220 x 190	3	for Klaka Set 3	water clear	7-14875
288 x 338 x 285	2	for Klaka Set 2	water clear	7-14873

## Custom-assembled tilt-open container modules



External dimensions W x H x D <i>mm</i>	Features	Colour	Ref. no.
602 x 410 x 108	3 x Klaka Set 6	beige	7-14856
	2 x Klaka Set 9 2 x Klaka Set 6	beige	7-14855
605 x 671 x 171	2 x Klaka Set 9 1 x Klaka Set 6 1 x Klaka Set 5 1 x Klaka Set 4	beige	7-14858
605 x 955 x 171	2 x Klaka Set 9 2 x Klaka Set 6 2 x Klaka Set 5 1 x Klaka Set 4	beige	7-14859

**i**

For standard applications, we offer four modules complete with various size tilt-open containers. The modules are supplied fully assembled and carton-packed (mounted on a wood laminate board with white coating).

## Stand alone tilt-open container cabinets

Sturdy wall mounted cabinets with ready-fixed Klaka kits

- Housing in silver grey or in blue
- Designed to accommodate 4 bin sizes to maximise use of space

### Wall mounted tilt-open container cabinets

External dimensions W x H x D <i>mm</i>	Number of containers	Features	Ref. no.	Ref. no.
665 x 910 x 250	16	4 x Klaka Set 4	7-14868	7-14869
	33	3 x Klaka Set 6 3 x Klaka Set 5	7-14864	7-14865
	42	7 x Klaka Set 6	7-14866	7-14867
	69	5 x Klaka Set 9 4 x Klaka Set 6	7-14870	7-14871



### Stand alone tilt-open container cabinets

External dimensions W x H x D <i>mm</i>	Number of containers	Features	Ref. no.	Ref. no.
665 x 2000 x 250	61	4 x Klaka Set 6 5 x Klaka Set 5 3 x Klaka Set 4	7-14862	7-14863
1270 x 2000 x 250	154	16 x Klaka Set 6 10 x Klaka Set 5 2 x Klaka Set 4	7-14860	7-14861

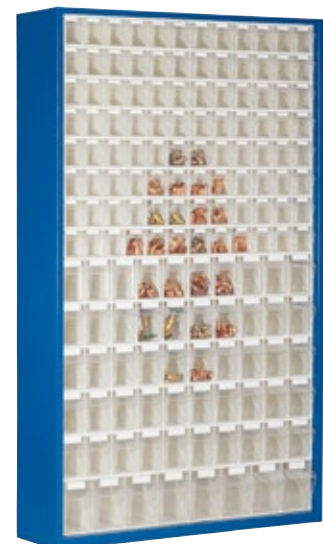



## Modular stacking containers EMB

### Compatibly sized to stack and interstack

EMB Stacking containers have been designed to support the Kanban principle in manufacturing and assembly environments and are also great for safely transporting items to other in-house workstations or to other companies in the supply chain of contract manufacturing business models. With a length of 600 mm, EMB containers are perfect for use in shelving with inclined shelves and on flow shelves of carton live storage installations.

Particular attention has been given to the “base geometry” featuring a pattern of stacking ribs that allows container stacking regardless of size. Even if a stack has been started with narrow-width containers, it is still possible to place broad-base containers on top without the need for de-stacking the existing pile and re-stacking it in the order of size.

Stacking rigidity is excellent and when moved, a container stack remains a stable unit. Unlike many other Kanban bins that often enough do not fit European size pallets, BITO EMB stacking containers make efficient use of the Euro pallet footprint.

**BITOBOX EMB**



**Modular stacking base**  
Allows mixed-size stacking. It is also possible to stack larger containers on top of smaller containers.



**Same height principle**  
Container heights are coordinated so that a stack of two low-height containers has exactly the height of the largest container.



**100% volume utilisation**  
Integrated pocket handles on short sides, hence all container sides are closed.



MODULAR STACKING CONTAINERS EMB

## Modular stacking containers EMB

Compatibly sized to stack and interstack

- **Excellent rigidity – safe stacking**
- **Large volume**
- **Smooth inside surfaces allow easy cleaning**
- **Ergonomic handles for easy handling**

**BITO-Plus**

BITO Quality  
5 years

05  
PP

supplied  
in any colour  
for orders  
exceeding 200 pcs.

+80°  
-20°



MODULAR STACKING CONTAINERS EMB

External dimensions L x W	Height	Internal dimensions L x W x H	Useable height	Volume	Load capacity	Stacking load	Bin type	Colour	Ref. no.
mm	mm	mm	mm	litres	kg	kg			
600 x 132	142,5	569 x 101 x 125	108	7.2	20	150	EMB611	blue	57-31563
600 x 266	142,5	569 x 227 x 125	108	16.2	20	150	EMB621	blue	57-31564
600 x 400	142,5	569 x 368 x 125	108	26.2	25	150	EMB641	blue	57-31565
600 x 400	270,0	566 x 368 x 253	186	52.7	30	300	EMB642	blue	57-31566

### Accessories



**A** Document pockets



**B** Covers for palletised loads

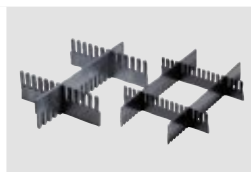

**C** Slot-in divider strips



**D** Transport dollies



**E** Multi-trip transport solution for bins and containers

Pos.	Description		Pcs/pack	Ref. no.
<b>A</b>	Document pockets	ideal for frequent exchange of inserts, adhesive fabric backing provides strong adhesion, colour transparent	10	6-5031
<b>B</b>	Covers for palletised loads	cover palletised bins and containers	1	9-18421
<b>C</b>	Slot-in divider strips	bin and container subdivision to your requirements, made from black recycled polypropylene, can be cut to required length with a wood or metal saw, upon request also available in ESD material, minimum order quantity: 500 pieces	10	43-18420
			10	7-15509
			10	43-18417
			10	43-18419
<b>D</b>	Transport dollies	complete with 4 swivel castors, designed for European size stacking containers: 1 x 600 x 400 mm or 2 x 400 x 300 mm, framework from glassfibre reinforced polyamide	1	43-1491
			1	43-21883
<b>E</b>	Multi-trip transport solution for bins and containers	can be moved without hand pallet truck or forklift truck, standard dimensions of 800 x 600 mm (1/2 Euro pallet), More information on page 126		

**European size stacking containers XL****Our most versatile container sets standards!**

European size stacking containers XL are supplied in a large choice of variations, are very versatile and have an extra large volume.

Ergonomically designed open hand grips are ideal for manual handling. In addition, a wide range of useful accessories make this market favourite perfect for almost any application.

**BITOBOX XL**





**i** [www.mybitobox.com](http://www.mybitobox.com)  
Configure colours and logos online!

## Base options



**Standard base**  
The standard base will be your choice for loads of up to 30 kg.

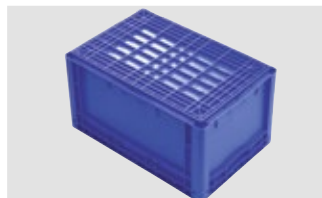

**Ribbed base**  
Ribbed base containers are perfect for loads of up to 50 kg. Base deflection is very low.

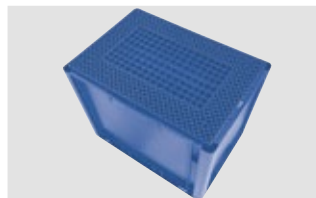

**Ribbed base RX**  
Containers with a ribbed RX base carry up to 50 kg. Base deflection is very low. Diagonal outer base ribbing ensures excellent use on conveyors.

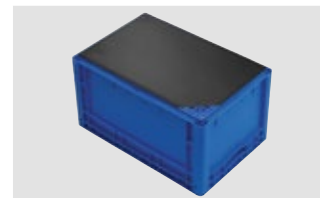

**Double base**  
Double base containers take loads of up to 50 kg and only have a minimum base deflection.

## Lid options



**Snap locked lid**  
Suited for stacking containers XLD21121, ideal for shipping spare parts etc. Additional security tagging with KLTP tags possible.



**Drop-on lid AD**  
Closes an individual container or a container stack and is suited for automated lidding and strap-sealing.



**Drop-on lid ASDV**  
One-piece lid, hinged on one side and closed with 2 snap-on fixtures on the other side.



**Hinged lid**  
Two-part lid suited for strap-sealing and security-tagging with KLTP security seals, excellent for distribution and transportation applications.

## Options



**Softtouch grips**  
Maximum convenience for manual handling. Available for stacking containers **XL4317**, **XL4322**, **XL4327**, **XL6417**, **XL6422** and **XL6427**. Minimum order quantity 100 pcs per type. Please ask for a quote.



**Water drainage holes**  
Supplied with drainage holes (compliant with fire protection directive VdS BG 4.3) upon request.



**Company logos**  
Company logos and messages can be applied by injection moulding, screen printing, pad printing or hot foil stamping – please ask!



**ESD version**  
Bins and containers marked with the ESD symbol are made from dissipative material to protect electronic parts and components from damage caused by sudden electrostatic discharge. Please ask.



## European size stacking containers XL

Our all-rounder for a broad range of applications

- Large volume
- Ergonomically designed open hand grips (except for 120 mm high bins in base dimensions of 200 x 150 mm, 300 x 200 mm, 400 x 300 mm and 600 x 400 mm)
- Several lid options



**BITO-Plus**

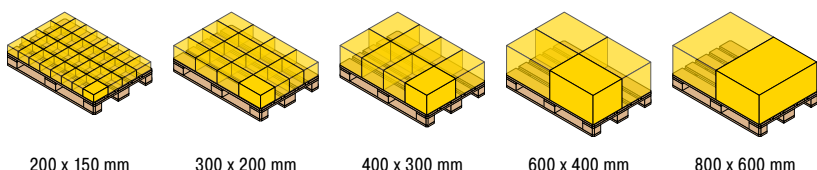

### Standard version

External dimensions L x W	Height	Internal dimensions L x W x H	Volume	Load capacity	Stacking load	Bin type	Ref. no.	Ref. no.	Ref. no.
mm	mm	mm	litres	kg	kg				
200 x 150	120	168 x 118 x 117	1,9	10		XL21121	43-18533	43-15306	43-15305
300 x 200	120	268 x 168 x 117	5,3	15		XL32121	43-18532	43-15239	43-15238
	170	268 x 168 x 167	6,0	15		XL32171	43-30388	43-30389	C0290-0505
	220	268 x 168 x 217	8,0	15		XL32221	43-30390	43-30391	C0290-0552
400 x 300	120	368 x 268 x 117	9,8	30	250	XL43121	43-18510	43-15308	43-15307
	170	368 x 268 x 167	15,0	30	250	XL43171	43-18514	43-14506	C0290-0439
	220	368 x 268 x 217	19,0	30	250	XL43221	43-18520	43-14507	C0290-0553
	270	368 x 268 x 267	24,0	30	250	XL43271	43-18526	43-14508	C0290-0554
600 x 400	120	568 x 368 x 116	21,0	15	300	XL64121	43-18476	C0290-0583	C0290-0555
	170	568 x 368 x 166	31,0	15	300	XL64171	43-18480	43-14509	C0290-0347
	220	568 x 368 x 216	41,0	15	300	XL64221	43-18486	43-14510	C0290-0556
	270	568 x 368 x 266	51,0	15	300	XL64271	43-18492	43-14511	C0290-0252
	320	568 x 368 x 316	62,0	20	300	XL64321	43-18498	43-14512	C0290-0557
	420	568 x 368 x 416	82,0	20	300	XL64421	43-18504	43-14513	C0290-0558
800 x 600	120	762 x 562 x 115	43,0	60	800	XL86121	43-22586		
	220	762 x 562 x 215	86,0	60	800	XL86221	43-22594		
	320	762 x 562 x 315	128,0	60	800	XL86321	43-20259		
	420	762 x 562 x 415	170,0	60	800	XL86421	43-22555		
	520	762 x 562 x 515	213,0	60	800	XL86521	43-22570		



## With hinged two-part lid

External dimensions L x W	Height	Internal dimensions L x W x H	Volume	Load capacity	Stacking load	Bin type	Ref. no.	Ref. no.	Ref. no.
mm	mm	mm	litres	kg	kg				
300 x 200	138	268 x 168 x 117	3,7	15		XLD32121	43-18583	43-30431	C0290-0586
	188	268 x 168 x 167	6,0	15		XLD32171	43-30403	43-30404	C0290-0326
	238	268 x 168 x 217	8,3	15		XLD32221	43-30405	43-30406	C0290-0559
400 x 300	138	368 x 268 x 117	10,0	30	250	XLD43121	43-18512	43-19879	C0290-0589
	188	368 x 268 x 167	15,0	30	250	XLD43171	43-18517	43-14514	C0290-0327
	238	368 x 268 x 217	20,0	30	250	XLD43221	43-18523	43-14515	C0290-0560
	288	368 x 268 x 267	25,0	30	250	XLD43271	43-18529	43-14516	C0290-0561
600 x 400	138	568 x 368 x 116	22,0	15	300	XLD64121	43-18478	C0290-0584	C0290-0562
	188	568 x 368 x 166	32,0	15	300	XLD64171	43-18483	43-14517	C0290-0563
	238	568 x 368 x 216	43,0	15	300	XLD64221	43-18489	43-14518	C0290-0564
	288	568 x 368 x 266	53,0	15	300	XLD64271	43-18495	43-14519	C0290-0313
	338	568 x 368 x 316	63,0	20	300	XLD64321	43-18501	43-14520	C0290-0565
	438	568 x 368 x 416	84,0	20	300	XLD64421	43-18507	43-14521	C0290-0566
800 x 600	138	762 x 562 x 115	43,0	60	800	XLD86121	43-22589		
	238	762 x 562 x 215	86,0	60	800	XLD86221	43-22599		
	338	762 x 562 x 315	128,0	60	800	XLD86321	43-20264		
	538	762 x 562 x 515	213,0	60	800	XLD86521	43-22577		
	438	762 x 562 x 415	170,0	60	800	XLD86421	43-22561		



## Hinged on one side and closed with 2 snap locks on the other side

External dimensions L x W	Height	Internal dimensions L x W x H	Volume	Load capacity	Stacking load	Bin type	Ref. no.	Ref. no.	Ref. no.
mm	mm	mm	litres	kg	kg				
200 x 150	138	168 x 118 x 117	1,6	10		XLD21121	43-14294		
300 x 200	138	268 x 168 x 117	3,7	15		XL32121ASDV	43-31512	43-31513	C0290-0587
	188	268 x 168 x 167	6,0	15		XL32171ASDV	43-30411	43-30412	C0290-0570
	238	268 x 168 x 217	8,3	15		XL32221ASDV	43-30413	43-30414	C0290-0571
400 x 300	138	368 x 268 x 117	9,7	30	250	XL43121ASDV	43-22258	43-22267	C0290-0590
	188	368 x 268 x 167	14,0	30	250	XL43171ASDV	43-22259	43-22268	C0290-0572
	238	368 x 268 x 217	19,0	30	250	XL43221ASDV	43-22260	43-22269	C0290-0573
	288	368 x 268 x 267	24,0	30	250	XL43271ASDV	43-22261	43-22270	C0290-0574
600 x 400	138	568 x 368 x 116	20,0	15	300	XL64121ASDV	43-22252	C0290-0582	C0290-0575
	188	568 x 368 x 166	31,0	15	300	XL64171ASDV	43-22253	43-22262	C0290-0576
	238	568 x 368 x 216	41,0	15	300	XL64221ASDV	43-22254	43-22263	C0290-0577
	288	568 x 368 x 266	51,0	15	300	XL64271ASDV	43-22255	43-22264	C0290-0578
	338	568 x 368 x 316	61,0	20	300	XL64321ASDV	43-22256	43-22265	C0290-0579
	438	568 x 368 x 416	82,0	20	300	XL64421ASDV	43-22257	43-22266	C0290-0580

### European size stacking containers XL with perforated base and sides

Light-weight and robust – with perforated sides to ensure optimum air flow

- **Perforated base and sides**
- **Large volume**
- **The ribbing adds to the height of the base, thus avoiding that your products get in direct contact with the floor**
- **Ergonomically designed open hand grips (except for 120 mm high bins in base dimensions of 200 x 150 mm, 300 x 200 mm, 400 x 300 mm and 600 x 400 mm)**
- **Colour: blue**



EUROPEAN SIZE STACKING CONTAINERS

#### BITO-Plus



Accessories to match from page 60

#### **i** BITO info

120 mm high containers are supplied with solid sides

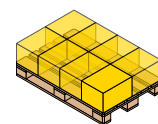

400 x 300 mm

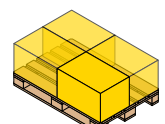

600 x 400 mm



## With perforated base and perforated sides

External dimensions L x W <i>mm</i>	Height <i>mm</i>	Description	Internal dimensions L x W x H <i>mm</i>	Volume <i>litres</i>	Load capacity <i>kg</i>	Stacking load <i>kg</i>	Bin type	Ref. no.
400 x 300	120	with perforated base and solid sides	368 x 268 x 102	8.3	35	250	XL43123	43-18511
	170	with perforated base and perforated sides	368 x 268 x 152	13	35	250	XL43173	43-18515
	220	with perforated base and perforated sides	368 x 268 x 202	18	35	250	XL43223	43-18521
	270	with perforated base and perforated sides	368 x 268 x 252	23	35	250	XL43273	43-18527
600 x 400	120	with perforated base and solid sides	568 x 368 x 102	18	35	300	XL64123	43-18477
	170	with perforated base and perforated sides	568 x 368 x 152	28	35	300	XL64173	43-18481
	220	with perforated base and perforated sides	568 x 368 x 202	38	35	300	XL64223	43-18487
	270	with perforated base and perforated sides	568 x 368 x 252	49	35	300	XL64273	43-18493
	320	with perforated base and perforated sides	568 x 368 x 302	59	35	300	XL64323	43-18499
	420	with perforated base and perforated sides	568 x 368 x 402	79	35	300	XL64423	43-18505



## With hinged two-part lid

External dimensions L x W <i>mm</i>	Height <i>mm</i>	Description	Internal dimensions L x W x H <i>mm</i>	Volume <i>litres</i>	Load capacity <i>kg</i>	Stacking load <i>kg</i>	Bin type	Ref. no.
400 x 300	188	with perforated base and perforated sides	368 x 268 x 152	14	35	250	XLD43173	43-18518
	238	with perforated base and perforated sides	368 x 268 x 202	19	35	250	XLD43223	43-18524
	288	with perforated base and perforated sides	368 x 268 x 252	23	35	250	XLD43273	43-18530
600 x 400	188	with perforated base and perforated sides	568 x 368 x 152	29	35	300	XLD64173	43-18484
	238	with perforated base and perforated sides	568 x 368 x 202	40	35	300	XLD64223	43-18490
	288	with perforated base and perforated sides	568 x 368 x 252	50	35	300	XLD64273	43-18496
	338	with perforated base and perforated sides	568 x 368 x 302	60	35	300	XLD64323	43-18502
	438	with perforated base and perforated sides	568 x 368 x 402	81	35	300	XLD64423	43-18508



### European size stacking containers XL with ribbed base RX

Reinforced corners and base ribbing provide strength and high stability – ideal for automated bin storage

- Outer base ribbing for quiet travel on conveyors
- Large volume
- Ergonomically designed open hand grips (except for 120 mm high bins in base dimensions of 200 x 150 mm, 300 x 200 mm, 400 x 300 mm and 600 x 400 mm)
- Open hand grips are optionally available with soft touch cushioning
- Ideal for use in automated bin storage
- Optionally available with drainage holes in the base
- Colour: blue

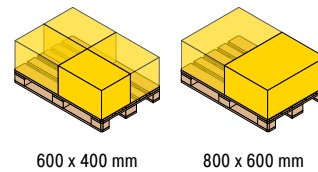

#### BITO-Plus



#### i BITO info

\*All values assume an ambient temperature of 23°C, long side-on container handling and uniformly distributed loads. Also suited for automated small parts storage. Outer diagonal base ribbing ensures quiet travel on conveyors.

Accessories to match from page 60  
More variants sized 800 x 600 mm with view and pick opening can be found in our online shop.

External dimensions L x W	Height	Internal dimensions L x W x H	Volume	Stacking load	Bin type	Ref. no.
mm	mm	mm	litres	kg		
600 x 400	120	568 x 368 x 102	18	300	XL64121RX	43-30204
	170	568 x 368 x 152	28	300	XL64171RX	43-30205
	220	568 x 368 x 202	38	300	XL64221RX	43-30206
	270	568 x 368 x 252	49	300	XL64271RX	43-30207
	320	568 x 368 x 302	60	300	XL64321RX	43-30208
	420	568 x 368 x 402	79	300	XL64421RX	43-22584
800 x 600	320	762 x 562 x 295	118	800	XL86321RX	C0290-1032



#### With hinged two-part lid

External dimensions L x W	Height	Internal dimensions L x W x H	Volume	Stacking load	Bin type	Ref. no.
mm	mm	mm	litres	kg		
600 x 400	138	568 x 368 x 102	18	300	XLD64121RX	43-30267
	188	568 x 368 x 152	28	300	XLD64171RX	43-30268
	238	568 x 368 x 202	38	300	XLD64221RX	43-30269
	288	568 x 368 x 252	49	300	XLD64271RX	43-30270
	338	568 x 368 x 302	69	300	XLD64321RX	43-30271
	438	568 x 368 x 402	79	300	XLD64421RX	43-30272
800 x 600	338	762 x 562 x 295	118	800	XLD86321RX	C0290-1033

## European size stacking containers XL with double base

Ideal for handling heavy loads – ideal for automated storage

- Extremely quiet travel on all types of conveyors
- Flat outer base avoids accumulation of dirt
- Large volume
- Ergonomically designed open hand grips (except for 120 mm high bins in base dimensions of 200 x 150 mm, 300 x 200 mm, 400 x 300 mm and 600 x 400 mm)
- Open hand grips are optionally available with soft touch cushioning
- All containers can be subdivided to suit individual requirements
- Ideal for use in automated bin storage
- Optionally available with drainage holes in the base
- Colour: blue



red dot

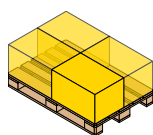

600 x 400 mm

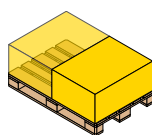

800 x 600 mm

**BITO-Plus**

supplied in any colour for orders exceeding 200 pcs.

**i BITO info**

**Load capacity in automated small parts storage, BITO type "AKL":** base deflection < 2 mm. Load capacity in compliance with EN13117: max. base deflection 3% measured along diagonal base line  
 \*All values assume an ambient temperature of 23°C, long side-on container handling and uniformly distributed loads.

**Please note: Some light barrier systems do not recognise bins with a black base. We are happy to offer bins with the base in the same colour as the bin.**



External dimensions L x W	Height	Internal dimensions L x W x H	Volume	Load capacity AKL	Load capacity EN13117	Stacking load	Bin type	Ref. no.
mm	mm	mm	litres	kg	kg	kg		
600 x 400	120	568 x 368 x 102	19	50	100	300	XL64121D	43-19029
	170	568 x 368 x 152	29	50	100	300	XL64171D	43-19030
	220	568 x 368 x 202	40	50	100	300	XL64221D	43-19031
	270	568 x 368 x 252	50	50	100	300	XL64271D	43-19032
	320	568 x 368 x 302	60	50	100	300	XL64321D	43-18707
	420	568 x 368 x 402	81	50	100	300	XL64421D	43-19033
800 x 600	120	762 x 562 x 101	36	80	200	800	XL86121D	43-22588
	220	762 x 562 x 201	79	80	200	800	XL86221D	43-22597
	320	762 x 562 x 301	121	80	200	800	XL86321D	43-20261
	420	762 x 562 x 401	164	80	200	800	XL86421D	43-22559
	520	762 x 562 x 501	206	80	200	800	XL86521D	43-22574

### With hinged two-part lid

External dimensions L x W	Height	Internal dimensions L x W x H	Volume	Load capacity AKL	Load capacity EN13117	Stacking load	Bin type	Ref. no.
mm	mm	mm	litres	kg	kg	kg		
600 x 400	138	568 x 368 x 102	19	50	100	300	XLD64121D	43-14300
	188	568 x 368 x 152	29	50	100	300	XLD64171D	43-14302
	238	568 x 368 x 202	40	50	100	300	XLD64221D	43-14304
	288	568 x 368 x 252	50	50	100	300	XLD64271D	43-14306
	338	568 x 368 x 302	60	50	100	300	XLD64321D	43-14308
	438	568 x 368 x 402	81	50	100	300	XLD64421D	43-14310
800 x 600	138	762 x 562 x 101	36	80	200	800	XLD86121D	43-22591
	238	762 x 562 x 201	79	80	200	800	XLD86221D	43-22602
	338	762 x 562 x 301	121	80	200	800	XLD86321D	43-20265
	438	762 x 562 x 401	164	80	200	800	XLD86421D	43-22565
	538	762 x 562 x 501	206	80	200	800	XLD86521D	43-22581

### Insert dividers

Easy to assemble in three steps

- Bin and container subdivision to your requirements
- Can be removed at any time
- Every divider (10 mm thick) is supplied with 2 side caps
- Divider caps can be screw-fixed or riveted
- Height options: 80, 130, 180, 230 mm, other heights upon request
- Prices and delivery periods upon request



#### **i** BITO info

Easy to assemble in three steps:

##### **Step 1**

The side caps have small pins that perfectly fit into the pre-drilled holes in the container sides. Containers can be supplied with drill holes, however it is also possible to drill holes later on.

##### **Step 2**

Insert one side of the divider into the pre-drilled holes.

##### **Step 3**

Then fix the other side of the divider to the container.

Spreaders inside the divider caps ensure a firm fit and prevent loss.

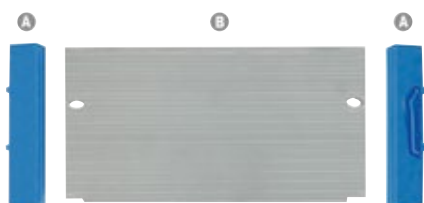

A: Side caps  
B: Twin wall divider, 10 mm thick

### Slot-in divider strips

Subdivide containers to suit product requirements!

- Bin and container subdivision to your requirements
- Made from black recycled polypropylene
- Can be cut to required length with a wood or metal saw
- Upon request also available in ESD material, minimum order quantity: 500 pieces

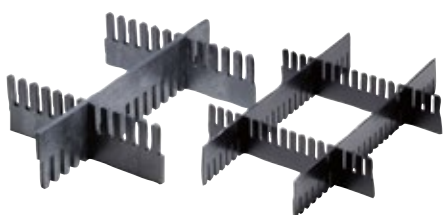

#### For European size stacking containers BN/XL and small parts containers KLT

Length <i>mm</i>	Height <i>mm</i>	Material thickness <i>mm</i>	Product type	Pcs/pack	Ref. no.
950	55	10	SSU55/11	10	43-18419
	120	10	SSU120/11	10	43-18420
1150	50	5	SSU50/5	10	43-18417
	80	5	SSU80/5	10	43-18418
	180	5	SSU180/5	10	7-15509

## Insert bins

### type EK

Make maximum use of space and stock several references in the same bin!

- For easy subdivision and full use of space
- Optimised grip solution for easy positioning and removal
- Further subdivision possible, bins can be stacked



### Type EK, for European size stacking containers XL

	To suit containers sized L x W <i>mm</i>	Format	External dimensions L x W x H <i>mm</i>	Volume <i>litres</i>	Bin type	Colour	Pcs/pack	Ref. no.
	400 x 300	1/4	178 x 129 x 90	1.7	EK17129XL	black	32	43-20001
		1/2 crosswise	258 x 178 x 90	3.5	EK25179XL	black	16	43-20005
	600 x 400	1/8	178 x 139 x 90	1.8	EK17139XL	black	32	43-19999
		1/4	277 x 178 x 90	3.7	EK27179XL	black	16	43-20003
		1/2 crosswise	358 x 277 x 90	7.6	EK35279XL	black	8	43-20007
		1/2 lengthwise	557 x 178 x 90	7.6	EK55179XL	black	8	43-19998

### Accessories



A Cross dividers



B Longitudinal dividers



C Dust covers

Pos.	Description		Accepts bin type	Product type	Pcs/pack	Ref. no.
A	Cross dividers	allow further subdivision of insertable bins	EK17129KLT, EK17129XL, EK17139XL, EK25179XL, EK26179KLT, EK27179XL, EK53179KLT, EK55179XL	QT179	10	9-16502
			EK35279XL	QT279	10	9-16755
B	Longitudinal dividers		EK25169KLT, EK25179XL	LT2519	10	9-16772
			EK27179XL	LT2719	10	43-16774
			EK35269KLT, EK35279XL	LT3529	10	9-16775
			EK55179XL	LT5519	10	43-16777
C	Dust covers	reliable protection against soiling, excellent stacking capacity also applies for lidded containers	EK17129KLT, EK17129XL	SD1712	10	9-16870
			EK17139XL	SD1713	10	43-16871
			EK25179XL	SD2517	10	43-16880
			EK17139XL	SD2717	10	43-16878
			EK35279XL	SD3527	10	43-16876
			EK55179XL	SD5517	10	43-16874



### Insert bins

#### type EEK

Make maximum use of space and stock several references in the same bin!

- For easy subdivision and full use of space
- With inward pointing integral handles

#### BITO-Plus



#### Type EEK, for European size stacking containers XL

To suit containers sized L x W		Format	External dimensions L x W x H	Volume	Bin type	Colour	Pcs/pack	Ref. no.
			mm	litres				
1/4 EEK171214XL	1/4 EEK171214XL	1/4	179 x 129 x 140	2.5	EEK171214XL	black	20	43-51063
	1/4 EEK171214XL							
1/8 EEK17113XL 1/8 EEK17113XL 1/2 crosswise EEK35213XL 1/4 EEK27178XL EEK27113XL	1/2 crosswise EEK35213XL	1/8	178 x 138 x 85	1.7	EEK17138XL	black	32	43-31322
		1/8	179 x 138 x 133	2.8	EEK17113XL	black	16	43-22687
		1/4	279 x 179 x 85	3.6	EEK27178XL	black	16	43-22540
		1/4	277 x 178 x 133	6.0	EEK27113XL	black	8	43-22686
		1/2 crosswise	358 x 277 x 85	7.4	EEK35278XL	black	8	43-31324
		1/2 crosswise	358 x 277 x 133	11.0	EEK35213XL	black	4	43-22685
		1/2 lengthwise	558 x 179 x 85	7.4	EEK55178XL	black	8	43-22537
		1/2 lengthwise	557 x 178 x 133	11.7	EEK55113XL	black	4	43-31325
1/2 lengthwise EEK55178XL								

### Cut out moulded inserts for components or tools

Everything within easy reach!

- Polystyrene tool inlays for order quantities from 500 pcs
- Our versatile tool system keeps tool costs low
- Material thickness between 2 and 5 mm, tool heights of up to 120 mm depending on material thickness
- Prices and delivery by quotation
- Designed to fit your tool
- Various colours and dissipative ESD versions can be supplied

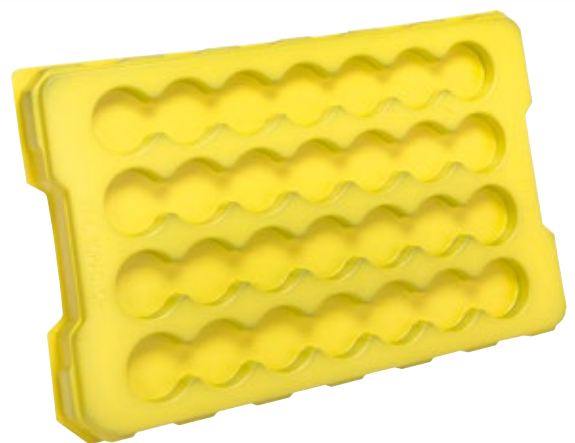

For XL containers  
sized 400 x 300 mm and 600 x 400 mm



For KLT containers  
sized 400 x 300 mm and 600 x 400 mm

## Accessories



**A** Drop-on lids



**B** Drop-on lid



**C** Security seals



**D** Security seals

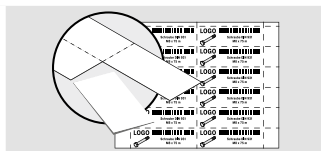

**E** Label sheets



**F** Label covers



**G** Transport dollies



**H** Transport dollies



**I** Covers for palletised loads



**J** Add-on fork entry shoes



**K** Grip closures

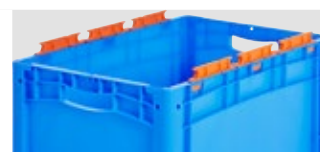

**L** Sides with bag holder notches

Pos.	Description	Colour	Dimensions mm	Product type	Pcs/pack	Ref. no.
<b>A</b>	Drop-on lids will cover container stacks, can also be used to close individual containers, suited for automated lidding and strap-sealing	grey	L 200 x W 150	AD21	1	43-30209
		blue	L 300 x W 200	AD32XL	1	43-30392
		grey	L 300 x W 200	AD32XL	1	43-C0324-0022
		red	L 300 x W 200	AD32XL	1	43-30393
		blue	L 400 x W 300	AD43	1	43-20303
		red	L 400 x W 300	AD43	1	43-20498
		blue	L 600 x W 400	AD64	1	43-20301
		red	L 600 x W 400	AD64	1	43-20494
<b>B</b>	Drop-on lid will cover container stacks, can also be used to close individual containers	grey	L 800 x W 600	SLS86-46	1	52-30500
<b>C</b>	Security seals tear-off security seals, suited for all XL and KLT containers except for containers sized 800 x 600 mm, colour: red	red		KLTP	500	9-16271
<b>D</b>	Security seals single use security seals, suited for all MB and XL containers sized 800 x 600 mm at the base, prevent tampering and opportunistic theft, 2 security seals required per container, colour: red, customised marking and colours on request	red		MBP2	500	6-15705
<b>E</b>	Label sheets pre-perforated blank label sheets, ready for direct printing, suited for laser and inkjet printers, on white DIN A4 sheets, 140 g/m <sup>2</sup> , 25 sheets per pack, colour white	white	W 210 x H 74	46-20778	100	46-20778
<b>F</b>	Label covers angled upper edge allows easy label inserting from the top, suited for all XL and KLT containers	water clear	W 209 x H 67	KLT-ET1	10	9-20053
		water clear	W 218 x H 80	KLT-ET2	10	9-20054
<b>G</b>	Transport dollies complete with 4 swivel castors, designed for European size stacking containers: 1 x 600 x 400 mm or 2 x 400 x 300 mm, framework from glassfibre reinforced polyamide	RAL 5007 Brilliant blue	L 620 x W 420	TR64	1	43-1491
		RAL 5007 Brilliant blue	L 620 x W 420	TR64G	1	43-21883
<b>H</b>	Transport dollies supplied with 2 swivel and 2 fixed castors, suited for containers sized 800 x 600 mm, made from polypropylene	anthracite grey	L 800 x W 600 x H 198	RU86.125	1	43-1150
<b>I</b>	Covers for palletised loads cover palletised bins and containers	black	L 1220 x W 820	PAH12.80	1	9-18421
<b>J</b>	Add-on fork entry shoes easy to mount and to remove, easy to retro-fit by bolt-on fitting to double base containers, kit includes 2 runners and 10 bolts	grey		43-20273	1	43-20273
<b>K</b>	Grip closures suited for European size stacking containers XL with a height of 170, 220 and 270 mm except for containers sized 800 x 600 mm, easy clip-in fixing to close grip openings	grey		GV-XL270	1	43-31450
		grey		GV-XL320	1	43-31448
<b>L</b>	Sides with bag holder notches clip-on fitting to MB, XL and KLT containers, practical for keeping bags open for easy filling, can be retro-fitted, can be removed, colour: grey (photo shows test colour)	grey		MB-BR64D	1	6-31553

## European size stacking containers BN

The European size classic for heavy loads

- Extremely sturdy containers with European footprint
- Available with solid or with perforated sides
- All containers come with a closed base as standard
- Large volume
- Ergonomic through-grips improve handling convenience
- Also available with view and pick opening
- Colour: blue



**BITO-Plus**

BITO Quality  
5 years

05  
PP

ESD  
version on request

+80°  
-20°

supplied in any colour for orders exceeding 200 pcs.

### BITOBOX BN

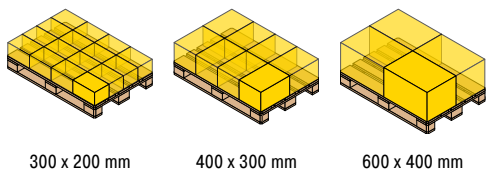

300 x 200 mm

400 x 300 mm

600 x 400 mm

### With perforated sides

External dimensions L x W	Height	Internal dimensions L x W x H	Volume	Load capacity	Stacking load	Bin type	Ref. no.
mm	mm	mm	litres	kg	kg		
400 x 300	153	360 x 260 x 150	14	30	200	BN4312	4-1279
	215	360 x 260 x 211	20	40	200	BN4322	4-1280
	265	360 x 260 x 261	24	50	250	BN43262	4-1281
600 x 400	130	560 x 360 x 126	25	25	400	BN6412	4-1282
	215	560 x 360 x 211	42	30	400	BN6422	4-1283
	315	560 x 360 x 311	62	40	400	BN6432	4-1284
	415	560 x 360 x 411	82	40	400	BN6442	4-1285

### With solid sides

External dimensions L x W	Height	Internal dimensions L x W x H	Volume	Load capacity	Stacking load	Bin type	Ref. no.
mm	mm	mm	litres	kg	kg		
300 x 200	153	261 x 161 x 150	6	14		BN321	4-1270
400 x 300	153	360 x 260 x 150	14	30	250	BN4311	4-1271
	215	360 x 260 x 211	20	50	250	BN4321	4-1272
	265	360 x 260 x 261	24	50	250	BN43261	4-1273
600 x 400	78	560 x 360 x 74	15	20	400	BN6407	4-1274
	130	560 x 360 x 126	25	30	400	BN6411	4-1275
	215	560 x 360 x 211	42	40	400	BN6421	4-1276
	315	560 x 360 x 311	62	50	400	BN6431	4-1277
	415	560 x 360 x 411	82	50	400	BN6441	4-1278



## Accessories



**A** Grip closures

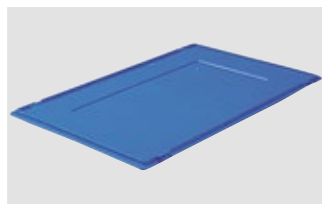

**B** Drop-on lids



**C** Hinge clips for lids



**D** Document clips



**E** Label covers



**F** Transport dollies

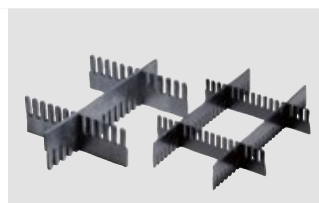

**G** Slot-in divider strips

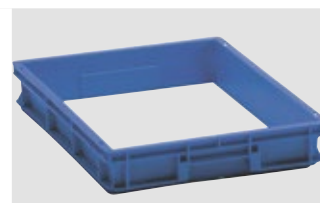

**H** Collars



**I** Multi-trip transport solution for bins and containers

Pos.	Description	Material thickness <i>mm</i>	Dimensions <i>mm</i>	Accepts bin type	Product type	Pcs/ pack	Ref. no.
<b>A</b>	Grip closures	-	-	European size stacking containers BN	GV3	50	4-18671
<b>B</b>	Drop-on lids	-	L 400 x W 300	-	KD430	1	4-1152
		-	L 600 x W 400	-	KD640	1	4-1153
<b>C</b>	Hinge clips for lids	-	-	-	DSV	100	4-1144
<b>D</b>	Document clips	-	L 80 x W 18	-	SH1	50	4-1492
<b>E</b>	Label covers	-	W 110 x H 46	except BD4314, BN6407	ET5	10	4-9454
<b>F</b>	Transport dollies	-	L 620 x W 420	-	TR64	1	43-1491
		-	L 620 x W 420	-	TR64G	1	43-21883
<b>G</b>	Slot-in divider strips	5	L 1150 x H 50	-	SSU50/5	10	43-18417
		5	L 1150 x H 80	-	SSU80/5	10	43-18418
		5	L 1150 x H 180	-	SSU180/5	10	7-15509
		10	L 950 x H 55	-	SSU55/11	10	43-18419
		10	L 950 x H 120	-	SSU120/11	10	43-18420
<b>H</b>	Collars	-	L 600 x W 400 x H 78	-	AR64	1	4-1568
<b>I</b>	Multi-trip transport solution for bins and containers	-	-	-	-	-	-





## XLmotion containers for automated systems

### Designed for automated storage & handling

The BITOBOX XLmotion is the no-compromise solution for automated systems, whether for automated bin or tray storage, shuttle-assisted solutions or for conveyor handling.

The new base design features a closed, perfectly flat outer frame around an open ribbed area for enhanced rigidity and almost noiseless travelling on conveyors. Operators will appreciate substantially reduced noise levels!

Optionally available dividers allow front to back or side to side container subdivision. Options range from 2 up to 16 compartments. The dividers safely connect to the container base and are easy to fit and to remove.

The sides are perfectly straight to allow a very good cube utilisation. The base design helps to reduce noise development on conveyors and to minimise investment in steel by allowing narrow-width seat profiles in AS/RS facilities. In view of these advantages, we decided that we should pass up on stacking compatibility with European standard size containers.

On top of this, the sides and corners of BITO XLmotion containers can be further customised. Minimum order quantities apply. Please note that XLmotion totes are compatible with all standard automated handling systems on the market.

**BITOBOX XLM**



- ① Large-capacity container
- ② Optional slots to fix dividers
- ③ Optional drainage holes in the base and/or the short sides
- ④ Open or closed grip holes on the short sides
- ⑤ Closed grips on the long sides
- ⑥ Ribbing can be adapted to customer AS/RS and conveyor requirements
- ⑦ New base design keeps travelling noise to an absolute minimum



Scan this QR code:  
**Product video**  
**BITOBOX XLmotion**  
[www.bitto.com/vid-xlmotionaudio-de](http://www.bitto.com/vid-xlmotionaudio-de)

## Product features



New base design featuring diagonal support ribbing in the centre and a double-base edge provides high rigidity and low-noise travelling on conveyors.



This silent runner substantially reduces noise levels in your warehouse!

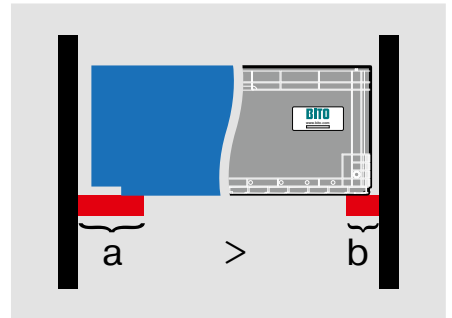

A wider base than is usual for European standard size stacking containers (389 mm instead of 363 mm) allows cutting down on the steelwork cost of AS/RS facilities.



XLmotion containers can be subdivided using robust and easy-to-mount cross and longitudinal dividers.

1/2		1/3		1/4	
1/4		1/6		1/8	
1/8		1/12		1/16	

Optional dividers for subdivision into 2 up to 16 compartments, dividers have a firm fit and are easy to insert or remove.



## XLmotion containers for automated systems

Designed for automated storage & handling

- **Very silent operation on conveyors**
- **Various possibilities for bin subdivision**
- **Large volume**
- **Possible savings on steel in automated storage facilities because support profiles for load carriers can be reduced in width**
- **Customised slotting pattern for divider positioning subject to minimum order quantity**



### BITO-Plus



supplied in any colour for orders exceeding 500 pcs.

CONTAINERS FOR AUTOMATED SYSTEMS

External dimensions L x W	Height	Internal dimensions L x W x H	Base width	Width of non-ribbed surface	Volume	Load capacity	Stacking load	Ref. no.
<i>mm</i>	<i>mm</i>	<i>mm</i>	<i>mm</i>	<i>mm</i>	<i>litres</i>	<i>kg</i>	<i>kg</i>	
599 x 399	120	569 x 369 x 100	389	min. 100	20.9	50	250	55-31534
	170	569 x 369 x 150	389	min. 100	31.4	50	250	55-31533
	220	569 x 369 x 200	389	min. 100	41.9	50	250	55-31397
	270	569 x 369 x 253	389	min. 100	53.0	50	250	55-31377
	320	569 x 369 x 300	389	min. 100	62.9	50	250	55-31398
650 x 450	420	569 x 369 x 400	389	min. 100	83.0	50	250	55-51094
	270	620 x 420 x 250	415	min. 100	60.0	50	250	55-51365
	320	620 x 420 x 300	415	min. 100	78.0	50	250	55-51110
	400	620 x 420 x 380	415	min. 100	99.0	50	250	55-51146

## Insert bins

type EEK, for XLmotion containers

- Ideal for storing different products in the same container
- Perfect subdivision of XLmotion containers sized 600 x 400 mm
- Every bin comes with 2 areas for barcode labels
- Optionally available with drainage holes in the base
- Made from BITO PP-RE



### Type EEK, for XLmotion containers

To suit containers sized L x W <i>mm</i>	Format	External dimensions L x W x H <i>mm</i>	Volume <i>litres</i>	Bin type	Colour	Ref. no.
600 x 400	1/4	283 x 183 x 140	5.8	EEK281814XLM	black	55-51066
	1/2 crosswise	367 x 283 x 140	12.0	EEK362814XLM	black	55-51067
	1/2 lengthwise	567 x 183 x 140	11.9	EEK561814XLM	black	55-51068





**Small parts containers KLT****Ideal for automated bin storage**

When rigidity is key...

The BITO KLT series meets the requirements of a modern warehouse environment in an ideal way. Featuring a sturdy corner design and three base variations, the container series can also be used for handling heavy loads. Ribbed base and double base KLT containers provide excellent rigidity, making them perfect for use in AS/RS systems.

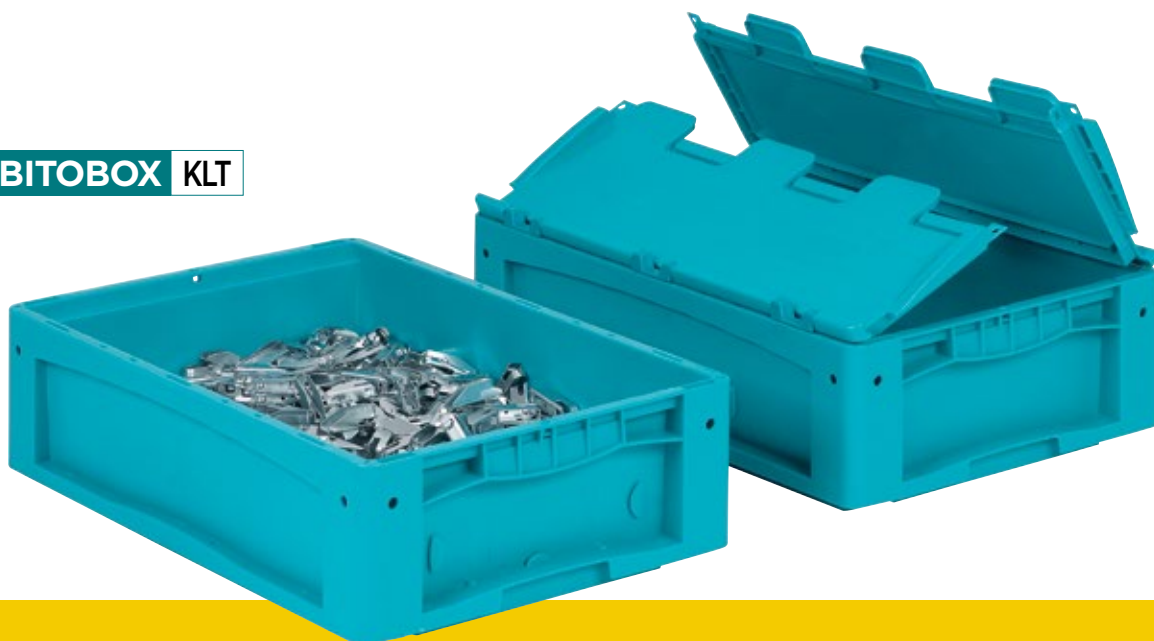
**BITOBOX KLT**

- 1 Opening to place hinge clip
- 2 Drainage holes
- 3 Opening for security seals or cable ties
- 4 Location hole for lifting devices
- 5 Hinged lid
- 6 Ergonomically designed hand grip
- 7 Integral groove for automated pulling
- 8 Optional: location for transponder accommodation
- 9 Location for position control devices
- 10 Area for label holders and document pockets
- 11 Container centering holes
- 12 Ideal surface for belt conveying
- 13 Marking space for messages applied by pad print, hot foil stamping or injection moulding

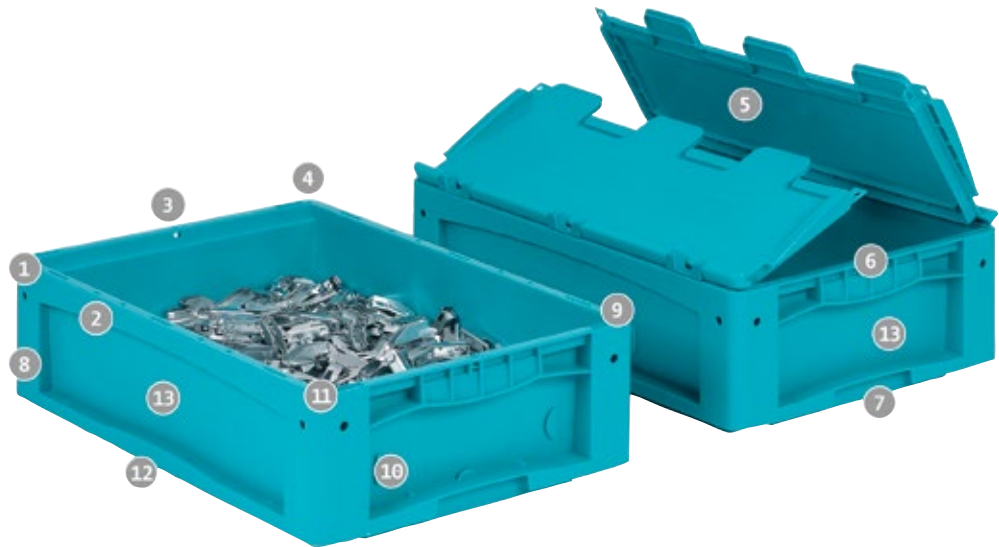

**i** [www.mybitobox.com](http://www.mybitobox.com)  
Configure colours and logos online!

## Suited for ...



**Use on conveyors**  
Smooth operation on all conveyor types. Excellent travel characteristics on roller tracks and roller conveyor lanes, on belt and chain conveyors, on transfer conveyors etc.



**Storage/order picking**  
Ideal for order picking and storage in manually serviced or in automated facilities. Particularly suited for carton live storage and AS/RS systems.



**Transport**  
Perfectly adapted to all common pallet sizes on the market for optimum use of loading space. Very good stacking stability with loads up to 500 kg, regardless of whether containers are stacked with lid or without lid.



**Manual handling**  
Ergonomically designed hand grips for easy lifting and carrying, even if containers are full loaded.

## Base options



**Standard base**  
Maximum base deflection 3% (measured along diagonal base line) for loads of 30 to 50 kg (depending on container size). All values assume uniformly distributed loads, an ambient temperature of 23 °C and long-side on handling in automated storage facilities!



**Ribbed base**  
Maximum base deflection  $\leq 1$  mm for loads up to 50 kg. All values assume uniformly distributed loads, an ambient temperature of 23 °C and long-side on handling in automated storage facilities!



**Double base**  
Maximum base deflection  $\leq 1$  mm for loads up to 75 kg. All values assume uniformly distributed loads, an ambient temperature of 23 °C and long-side on handling in automated storage facilities!

## Stacking safety



**Safe stacking**  
Compatible with all established stacking container and VDA container brands. Excellent stacking safety with and without lid.



### Small parts containers KLT

For any application where material stability is important

- Closed sides without grip opening ensure 100% volume utilisation
- Excellent stacking safety with lid and without lid
- Perfect for use on conveyors, storage and order picking, transport and manual handling
- Ergonomic handles for easy handling
- Fixtures for labels and document pockets
- Colour: turquoise

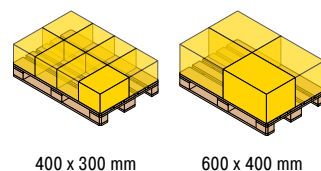

EUROPEAN SIZE STACKING CONTAINERS

**BITO-Plus**

➔ Pre-perforated print-on labels for your own printer on page 291

External dimensions L x W	Height	Internal dimensions L x W x H	Volume	Load capacity	Stacking load	Bin type	Ref. no.
mm	mm	mm	litres	kg	kg		
400 x 300	120	341 x 268 x 116	8.9	25*	300	KLT43120	9-18464
	170	341 x 268 x 166	13	25*	300	KLT43170	9-18470
	220	341 x 268 x 216	17	50	300	KLT43220	9-16794
	270	341 x 268 x 266	22	50	300	KLT43270	9-16801
600 x 400	120	541 x 368 x 116	19	30	500	KLT64120	9-16096
	170	541 x 368 x 166	29	30	500	KLT64170	9-16805
	220	541 x 368 x 216	39	40	500	KLT64220	9-16273
	270	541 x 368 x 266	48	50	500	KLT64270	9-16809
	320	541 x 368 x 319	58	50	500	KLT64320	9-16813
	420	541 x 368 x 416	78	50	500	KLT64420	9-16817





**i** [www.mybitobox.com](http://www.mybitobox.com)

Configure colours and logos online!



## Hinged on one side and closed with 2 snap locks on the other side

External dimensions L x W	Height	Internal dimensions L x W x H	Volume	Load capacity	Stacking load	Bin type	Ref. no.
mm	mm	mm	litres	kg	kg		
400 x 300	138	341 x 268 x 116	8.90	25	300	KLT43120ASDV	9-22248
	188	341 x 268 x 166	13.50	25	300	KLT43170ASDV	9-22249
	238	341 x 268 x 216	17.80	50	300	KLT43220ASDV	9-22250
	288	341 x 268 x 266	22.20	50	300	KLT43270ASDV	9-22251
600 x 400	138	541 x 368 x 116	19.60	30	500	KLT64120ASDV	9-22243
	188	541 x 368 x 166	29.30	30	500	KLT64170ASDV	9-22244
	238	541 x 368 x 216	39.00	40	500	KLT64220ASDV	9-22245
	288	541 x 368 x 266	48.80	50	500	KLT64270ASDV	9-22242
	338	541 x 368 x 316	58.50	50	500	KLT64320ASDV	9-22246
	438	541 x 368 x 416	78.00	50	500	KLT64420ASDV	9-22247



## With hinged two-part lid

External dimensions L x W	Height	Internal dimensions L x W x H	Volume	Load capacity	Stacking load	Bin type	Ref. no.
mm	mm	mm	litres	kg	kg		
400 x 300	138	341 x 268 x 116	8.9	25*	300	KLTD43120	9-18467
	188	341 x 268 x 166	13	25*	300	KLTD43170	9-18473
	238	341 x 268 x 216	17	50	300	KLTD43220	9-16796
	288	341 x 268 x 266	22	50	300	KLTD43270	9-16803
600 x 400	138	541 x 368 x 116	19	30	500	KLTD64120	9-18098
	188	541 x 368 x 166	29	30	500	KLTD64170	9-16807
	238	541 x 368 x 216	39	40	500	KLTD64220	9-16275
	288	541 x 368 x 266	48	50	500	KLTD64270	9-16811
	338	541 x 368 x 316	58	50	500	KLTD64320	9-16815
	438	541 x 368 x 416	78	50	500	KLTD64420	9-16819





### Small parts containers KLT with ribbed base

Excellent rigidity – ideal for automated storage

- Ribbed base containers can carry 50 kg, sturdy design reduces base deflection to a minimum\*
- Developed for automated small parts storage
- Perfect for use on conveyors, storage and order picking, transport and manual handling



#### BITO-Plus

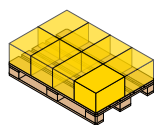
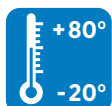

400 x 300 mm

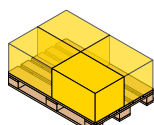

600 x 400 mm

#### i BITO info

\*All values assume an ambient temperature of 23°C, long side-on container handling and uniformly distributed loads.



External dimensions L x W	Height	Internal dimensions L x W x H	Volume	Load capacity	Stacking load	Bin type	Ref. no.
mm	mm	mm	litres	kg	kg		
400 x 300	220	341 x 268 x 200	16	50	300	KLTD43220R	9-16795
	270	341 x 268 x 250	20	50	300	KLTD43270R	9-16802
600 x 400	120	541 x 368 x 100	16	50	500	KLTD64120R	9-18097
	170	541 x 368 x 150	26	50	500	KLTD64170R	9-16806
	220	541 x 368 x 200	36	50	500	KLTD64220R	9-16274
	270	541 x 368 x 250	45	50	500	KLTD64270R	9-16810
	320	541 x 368 x 300	55	50	500	KLTD64320R	9-16814
	420	541 x 368 x 400	74	50	500	KLTD64420R	9-16818



#### With hinged two-part lid

External dimensions L x W	Height	Internal dimensions L x W x H	Volume	Load capacity	Stacking load	Bin type	Ref. no.
mm	mm	mm	litres	kg	kg		
400 x 300	238	341 x 268 x 200	16	50	300	KLTD43220R	9-16800
	288	341 x 268 x 250	20	50	300	KLTD43270R	9-16804
600 x 400	138	541 x 368 x 100	16	50	500	KLTD64120R	9-18099
	188	541 x 368 x 150	26	50	500	KLTD64170R	9-16808
	238	541 x 368 x 200	36	50	500	KLTD64220R	9-16276
	288	541 x 368 x 250	45	50	500	KLTD64270R	9-16812
	338	541 x 368 x 300	55	50	500	KLTD64320R	9-16816
	438	541 x 368 x 400	74	50	500	KLTD64420R	9-16820

## Small parts containers KLT with double base

Developed to meet the high demands of automated small parts storage

- Double base containers can carry up to 75 kg, sturdy design reduces base deflection to a minimum\*
- Perfect for use on conveyors, storage and order picking, transport and manual handling
- Colour: turquoise



**BITO-Plus**

BITO Quality  
5 years

05  
PP

supplied in any colour for orders exceeding 200 pcs.

+60°  
-20°

75 kg  
< 2 mm  
Base deflection\*

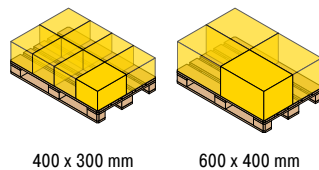

**i BITO info**

\*All values assume an ambient temperature of 23°C, long side-on container handling and uniformly distributed loads.  
**Please note: Some light barrier systems do not recognise bins with a black base. We are happy to offer bins with the base in the same colour as the bin.**



External dimensions L x W	Height	Internal dimensions L x W x H	Volume	Load capacity	Stacking load	Bin type	Ref. no.
mm	mm	mm	litres	kg	kg		
400 x 300	220	341 x 268 x 200	16	75	300	KLT43220D	9-17504
	270	341 x 268 x 250	20	75	300	KLT43270D	9-17506
600 x 400	120	541 x 368 x 100	16	75	500	KLT64120D	9-18100
	170	541 x 368 x 150	26	75	500	KLT64170D	9-17508
	220	541 x 368 x 200	36	75	500	KLT64220D	9-17517
	270	541 x 368 x 250	45	75	500	KLT64270D	9-17510
	320	541 x 368 x 300	55	75	500	KLT64320D	9-17512
	420	541 x 368 x 400	74	75	500	KLT64420D	9-17514

### With hinged two-part lid

External dimensions L x W	Height	Internal dimensions L x W x H	Volume	Load capacity	Stacking load	Bin type	Ref. no.
mm	mm	mm	litres	kg	kg		
400 x 300	238	341 x 268 x 200	16	75	300	KLTD43220D	9-17505
	288	341 x 268 x 250	20	75	300	KLTD43270D	9-17507
600 x 400	138	541 x 368 x 100	16	75	500	KLTD64120D	9-18101
	188	541 x 368 x 150	26	75	500	KLTD64170D	9-17509
	238	541 x 368 x 200	36	75	500	KLTD64220D	9-17518
	288	541 x 368 x 250	45	75	500	KLTD64270D	9-17511
	338	541 x 368 x 300	55	75	500	KLTD64320D	9-17513
	438	541 x 368 x 400	74	75	500	KLTD64420D	9-17515

## Small parts containers KLT

### Accessories

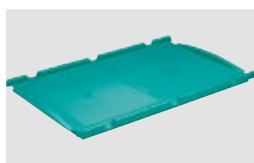

A Drop-on lids



B Security seals



C Locking systems BS



D Covers for palletised loads

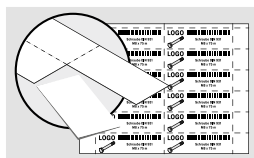

E Label sheets



F Labels



G Label covers



H Document pockets

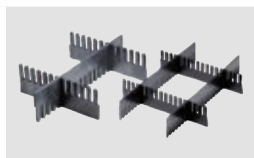

I Slot-in divider strips



J Transport dollies

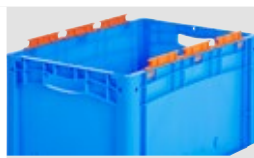

K Sides with bag holder notches



L Multi-trip transport solution for bins and containers

Pos.	Description	Colour	Accepts bin type	Product type	Pcs/pack	Ref. no.		
A	Drop-on lids	will cover container stacks, can also be used to close individual containers, suited for automated lidding and strap-sealing	turquoise	400 x 300 mm	AD43	1	43-20499	
				600 x 400 mm	AD64	1	43-20497	
B	Security seals	tear-off security seals, suited for all XL and KLT containers except for containers sized 800 x 600 mm, colour: red			KLTP	500	9-16271	
C	Locking systems BS	extra charge per container		for small parts containers KLT	BS1	1	7-14434	
D	Covers for palletised loads	cover palletised bins and containers		black	PAH12.80	1	9-18421	
E	Label sheets	pre-perforated blank label sheets, ready for direct printing, suited for laser and inkjet printers, on white DIN A4 sheets, 140 g/m <sup>2</sup> , 25 sheets per pack, colour white		white		46-20778	100	46-20778
F	Labels	white card labels, suited for all XL and KLT containers with a minimum height of 170 mm				XL21/60	50	43-14558
						XL21/74	50	43-14557
G	Label covers	angled upper edge allows easy label inserting from the top, suited for all XL and KLT containers	water clear without retaining fixture to prevent loss of label	KLT	KLT-ET1	10	9-20053	
		angled upper edge allows easy label inserting from the top, suited for all KLT containers with a minimum height of 170 mm and for XL containers sized 600 x 400 mm and a minimum height of 220 mm	water clear with retaining fixture to prevent loss of label	KLT	KLT-ET2	10	9-20054	
H	Document pockets	ideal for frequent exchange of inserts, adhesive fabric backing provides strong adhesion, colour transparent		transparent	MBET	10	6-5031	
I	Slot-in divider strips	bin and container subdivision to your requirements, made from black recycled polypropylene, can be cut to required length with a wood or metal saw, upon request also available in ESD material, minimum order quantity: 500 pieces	Material thickness 10 mm		SSU120/11	10	43-18420	
			Material thickness 5 mm		SSU180/5	10	7-15509	
					SSU50/5	10	43-18417	
			Material thickness 10 mm		SSU55/11	10	43-18419	
		Material thickness 5 mm		SSU80/5	10	43-18418		
J	Transport dollies	complete with 4 swivel castors, designed for European size stacking containers: 1 x 600 x 400 mm or 2 x 400 x 300 mm, framework from glassfibre reinforced polyamide	RAL 5007 Brilliant blue		TR64	1	43-1491	
					TR64G	1	43-21883	
K	Sides with bag holder notches	clip-on fitting to MB, XL and KLT containers, practical for keeping bags open for easy filling, can be retro-fitted, can be removed, colour: grey (photo shows test colour)	grey		MB-BR64D	1	6-31553	
L	Multi-trip transport solution for bins and containers	can be moved without hand pallet truck or forklift truck standard dimensions of 800 x 600 mm (1/2 Euro pallet), More information on page 126						

## Insert bins

### type EK

Make maximum use of space and stock several references in the same bin!

- For easy subdivision and full use of space
- Optimised grip solution for easy positioning and removal
- Further subdivision possible, bins can be stacked



### BITO-Plus



Scan this QR code:

Insertable bins

[www.bitto.com/web-kltek-de](http://www.bitto.com/web-kltek-de)

### Type EK, for small parts containers KLT

To suit containers sized L x W <i>mm</i>	Format	External dimensions L x W x H <i>mm</i>	Volume <i>litres</i>	Bin type	Colour	Pcs/pack	Ref. no.
400 x 300	1/4	165 x 129 x 90	1.6	EK16129KLT	black	32	9-20000
	1/2 crosswise	258 x 166 x 90	3.2	EK25169KLT	black	16	9-20004
600 x 400	1/8	178 x 129 x 90	1.7	EK17129KLT	black	32	9-19997
	1/4	263 x 178 x 90	3.5	EK26179KLT	black	16	9-20002
	1/2 crosswise	358 x 268 x 90	7.2	EK35269KLT	black	8	9-20006
	1/2 lengthwise	530 x 178 x 90	7.3	EK53179KLT	black	8	9-19996

Description		Accepts bin type	Product type	Pcs/pack	Ref. no.
Cross dividers	allow further subdivision of insertable bins	EK16129KLT, EK25169KLT	QT169	10	9-16753
		EK17129KLT, EK17129XL, EK17139XL, EK25179XL, EK26179KLT, EK27179XL, EK53179KLT, EK55179XL	QT179	10	9-16502
		EK35269KLT	QT269	10	9-16754
Dust covers	reliable protection against soiling, excellent stacking capacity also applies for lidded containers	EK16129KLT	SD1612	10	9-16872
		EK17129KLT, EK17129XL	SD1712	10	9-16870
		EK25169KLT	SD2516	10	9-16879
		EK26179KLT	SD2617	10	9-16877
		EK35269KLT	SD3526	10	9-16875
		EK53179KLT	SD5317	10	9-16873

## Insert bins

### type EEK

Make maximum use of space and stock several references in the same bin!

- For easy subdivision and full use of space
- With inward pointing integral handles



### Type EEK, for small parts containers KLT

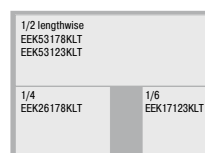

To suit containers sized L x W <i>mm</i>	Format	External dimensions L x W x H <i>mm</i>	Volume <i>litres</i>	Bin type	Colour	Pcs/pack	Ref. no.
600 x 400	1/8	178 x 129 x 85	1.6	EEK17128KLT	black	32	9-31321
	1/6	178 x 178 x 230	5.7	EEK17123KLT	black	6	9-30279
	1/4	265 x 179 x 85	3.4	EEK26178KLT	black	16	9-22539
	1/4	265 x 179 x 230	9.6	EEK26123KLT	black	4	9-31366
	1/2 lengthwise	530 x 179 x 230	18.0	EEK53123KLT	black	1	9-30280
	1/2 lengthwise	530 x 179 x 85	7.0	EEK53178KLT	black	8	9-22538
	1/2 crosswise	358 x 263 x 85	7.0	EEK35268KLT	black	8	9-31323
	1/2 crosswise	358 x 263 x 230	18.0	EEK35223KLT	black	2	9-51032



## Steel trays

Robust and rigid – great for automated storage

- Zinc-plated steel
- Collars increase the standard tray height from 38 mm up to 400 mm
- Very low base deflection
- With pressure-joined corners



Tray subdivision with steel sheet dividers



Collar to increase tray height, push-in fitting



Tray subdivision with insert bins EK

### i BITO info

Steel trays are used for heavy weight items (50 to 300 kg). With a very low base deflection, these steel trays ensure safe handling in automated storage facilities. By clipping on a collar or adding insert bins, it is possible to perfectly adapt the trays to your stock items.

TRAYS

## Plastic trays

- Allow automated handling of cartons, even if they are damaged
- Can be handled with all types of service vehicles
- Further variations upon request



### BITO-Plus



### Distribution trays DT 640

- Smooth base and ribbed edges at container base ensure trouble free travel on conveyors
- Inner ribbing ensures very good stability
- Inside dimensions suited for bins and cartons sized 600 x 400 mm

External dimensions L x W	Height	Internal dimensions L x W x H	Colour	Ref. no.
<i>mm</i>	<i>mm</i>	<i>mm</i>		
640 x 426	50	608 x 408 x 29	blue	45-20017

## Distribution trays DT 670

- Smooth base and ribbed edges at container base ensure trouble free travel on conveyors
- Inner ribbing ensures very good stability

External dimensions L x W	Height	Internal dimensions L x W x H	Colour	Ref. no.
<i>mm</i>	<i>mm</i>	<i>mm</i>		
670 x 410	70	629 x 379 x 50	blue	45-22696



## European size trays

- European size trays provide ample space for your products
- Ribbed edges at container base for smooth operation on conveyors

External dimensions L x W	Height	Internal dimensions L x W x H	Colour	Ref. no.
<i>mm</i>	<i>mm</i>	<i>mm</i>		
399 x 299	50	379 x 279 x 30	blue	45-21867
599 x 399	50	579 x 379 x 30	blue	45-21866

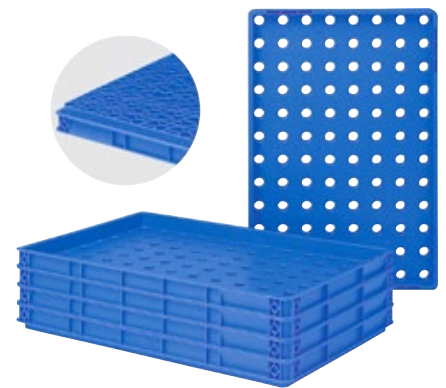

## Trays XLT

- Dimensions compatible with stacking container series BN, XL and KLT
- Ribbed edges at container base for smooth operation on conveyors

External dimensions L x W	Height	Internal dimensions L x W x H	Colour	Ref. no.
<i>mm</i>	<i>mm</i>	<i>mm</i>		
600 x 400	50	568 x 368 x 30	blue	45-22542



### **i** BITO info

#### Load holders for XLT64 storage trays

These optional load holders fix bins and containers lengthwise or crossways on a tray. Even a single smaller size container is securely held in place - shifting is excluded. Spring-mounted load holders even allow to fix several different size bins on the same tray.

## Trays XLT-P

- Dimensions compatible with stacking container series BN, XL and KLT
- Ribbed edges at container base for smooth operation on conveyors

External dimensions L x W	Height	Internal dimensions L x W x H	Colour	Ref. no.
<i>mm</i>	<i>mm</i>	<i>mm</i>		
600 x 400	55	568 x 368 x 30	blue	45-30286



### **i** BITO info

#### Load retention corners for XLT64-P

Optionally available: push-fit corners prevent cartons or bins from slipping sideways.

Multi-purpose containers MB

Your first choice for stacking and nesting: BITOBOX MB

The BITO MB container series in Euro footprint is the option of choice for distribution chains. Compared to one-way packaging such as cardboard boxes, MB containers are extremely robust, long lasting and save up to 75% on volume when nested. Suited for storage, order picking and transport alike, all containers of the MB series can be used as outer packaging. This means that your products do not need repacking allowing you to save on packaging waste, help the environment and conserve resources.

**BITOBOX MB**



NESTING AND FOLDING CONTAINERS





## Reusable packaging beats disposable packaging



**i** [www.mybitobox.com](http://www.mybitobox.com)

Configure colours and logos online!

## Product features



### Indented buffer zones

Trouble-free handling on conveyors, as indented buffers prevent same height containers from overriding in the case of jams.

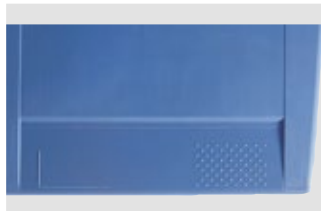

### Label areas

Label areas with both a smooth and a dimpled surface offer enough room for placing adhesive labels. As these areas are slightly recessed, the labels are reliably protected during nesting and de-nesting.



### Ideal travel characteristics

Designed with textured base and rounded edges for optimum use on conveyors and in live storage installations.



### Safe stacking

„Swing“ stacking rails maximise volume utilisation and ensure safe stacking. The rails lock into upright position to prevent swinging down by accident.



### Nesting

Simply turn the stacking rails into their side position for container nesting.



### Maximum use of volume

Smooth internal sides provide 100% volume utilisation and make sure that bins can be nested and de-nested without jamming.



### Easy cleaning

Smooth surfaces and drainage holes in the container rim allow fast, easy and thorough cleaning.



### Manual handling

Generously spaced and ergonomically designed hand grips, comfortable to use when container is loaded.



### Hinged lid

The hinged, interlocking two-piece lid has an integral recessed area to provide outstanding stacking stability. This standard lid comes firmly fitted to the container and can be sealed in various ways.



### Company logos

Company logos and messages can be applied by injection moulding, screen printing, pad printing or hot foil stamping – please ask!



### Strap-sealable hinged lid

The hinged lid has been developed for automated long and short side strap-sealing. Raised stacking edges guarantee maximum stacking stability.





## Multi-purpose containers MB

The range that stacks safely and nests away during empty storage

- **MB - 3 containers in 1**
- **1. Transport container**
- **2. Storage container**
- **3. Order picking box**
- **Nesting empty bins saves up to 75% on volume**
- **Designed for a long service life**
- **Reduce packaging waste**
- **Colour: dove blue**

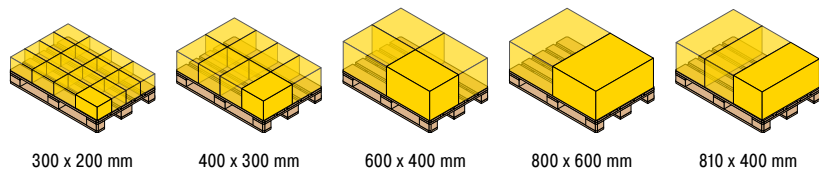

**BITO-Plus**

**i** [www.mybitobox.com](http://www.mybitobox.com)

Configure colours and logos online!



### Standard version

External dimensions L x W	Height	Volume	Load capacity	Bin type	Ref. no.
mm	mm	litres	kg		
300 x 200	153	5	15	MB32151	6-5015
400 x 300	173	16	14	MB43171	6-15864
	223	18	20	MB43221	6-11091
	273	22	25	MB43271	6-11092
	323	27	25	MB43321	6-11093
600 x 400	173	29	25	MB64171	6-11090
	223	38	30	MB64221	6-11089
	273	47	30	MB64271	6-11088
	323	58	35	MB64321	6-10802
	373	67	28	MBEC64371	79-51059
	423	74	35	MB64421	6-11087
800 x 400	323	76	35	MB84321	6-5045
	423	100	35	MB84421	6-5046
800 x 600	323	120	50	MB86321	6-15246
	423	158	50	MB86421	6-15255



### With hinged two-part lid

External dimensions L x W	Height	Volume	Load capacity	Stacking load	Bin type	Ref. no.
<i>mm</i>	<i>mm</i>	<i>litres</i>	<i>kg</i>	<i>kg</i>		
310 x 200	170	5	15	100	MBD32151	6-5017
410 x 300	190	16	14	150	MBD43171	6-16043
	240	18	20	150	MBD43221	6-11123
	290	22	25	150	MBD43271	6-11124
	340	27	25	150	MBD43321	6-11125
610 x 400	190	29	25	200	MBD64171	6-16766
	240	38	30	200	MBD64221	6-11119
	290	47	30	200	MBD64271	6-11120
	340	58	35	200	MBD64321	6-11121
	390	67	28	160	MBDEC64371	79-51075
	440	74	35	200	MBD64421	6-11122
800 x 600	353	115	50	300	MBD86321	6-15249
	423	154	50	300	MBD86421	6-15258
810 x 400	340	76	35	200	MBD84321	6-5053
	440	100	35	200	MBD84421	6-5054

#### **i** BITO info

All container sizes interstack even when strap-sealed!



### With hinged interlocking lid suited for strap-sealing

External dimensions L x W	Height	Volume	Load capacity	Stacking load	Bin type	Ref. no.
<i>mm</i>	<i>mm</i>	<i>litres</i>	<i>kg</i>	<i>kg</i>		
410 x 300	199	13	14	150	MBDU43171	6-30314
	249	17	20	150	MBDU43221	6-30315
	299	21	25	150	MBDU43271	6-30316
	349	25	25	150	MBDU43321	6-30317
610 x 400	199	29	25	200	MBDU64171	6-16861
	249	38	30	200	MBDU64221	6-16131
	299	47	30	200	MBDU64271	6-16133
	349	58	35	200	MBDU64321	6-16132
	399	67	28	160	MBECDU64371	6-51145
	449	74	35	200	MBDU64421	6-16134
810 x 400	349	77	35	200	MBDU84321	6-22647
	449	102	35	200	MBDU84421	6-22648

## Multi-purpose containers MB



### With mounted stacking rails

External dimensions L x W	Height	Volume	Load capacity	Stacking load	Bin type	Ref. no.
<i>mm</i>	<i>mm</i>	<i>litres</i>	<i>kg</i>	<i>kg</i>		
400 x 300	173	16	14	150	MBB43171	6-16011
	223	18	20	150	MBB43221	6-11126
	273	22	25	150	MBB43271	6-11117
	323	27	25	150	MBB43321	6-11118
600 x 400	173	29	25	200	MBB64171	6-11112
	223	38	30	200	MBB64221	6-11113
	273	47	30	200	MBB64271	6-11114
	323	58	35	200	MBB64321	6-11115
	373	67	28	160	MBBEC64371	79-51074
	423	74	35	200	MBB64421	6-11116
800 x 400	323	76	35	200	MBB84321	6-5049
	423	100	35	200	MBB84421	6-5050



### With hinged stacking seats

External dimensions L x W	Height	Volume	Load capacity	Stacking load	Bin type	Ref. no.
<i>mm</i>	<i>mm</i>	<i>litres</i>	<i>kg</i>	<i>kg</i>		
800 x 600	353	115	50	200	MBB86321	6-15252
	453	154	50	200	MBB86421	6-15261



### With polyamide swivel castors

External dimensions L x W	Height	Volume	Load capacity	Bin type	Ref. no.
<i>mm</i>	<i>mm</i>	<i>litres</i>	<i>kg</i>		
800 x 600	423	114	50	MB86321DROLL-K	6-19483
	523	151	50	MB86421DROLL-K	6-19485



### With plastic swivel castors

External dimensions L x W	Height	Volume	Load capacity	Bin type	Ref. no.
<i>mm</i>	<i>mm</i>	<i>litres</i>	<i>kg</i>		
800 x 600	423	114	50	MB86321DROLL-G	6-19484
	523	151	50	MB86421DROLL-G	6-19486



### With locking system

External dimensions L x W	Height	Base option	Load capacity	Stacking load	Volume	Lock type	Bin type	Ref. no.
<i>mm</i>	<i>mm</i>		<i>kg</i>	<i>kg</i>	<i>litres</i>			
410 x 300	240	Standard base	20	300	18	Lever lock BS2	MBD43221BS2	6-18127
610 x 400	340	Standard base	35	300	58	Cam lock BS1	MBD64321BS1	6-18125
	340	Standard base	35	300	58	Lever lock BS2	MBD64321BS2	6-18128
800 x 600	353	Standard base	50	300	120	Cam lock BS1	MBD86321 BS1	6-20286
	353	Ribbed base	50	300	109	Cam lock BS1	MBD86321R BS1	6-20287
	353	Double base	200	300	109	Cam lock BS1	MBD86321D BS1	6-20288
	453	Standard base	50	300	158	Cam lock BS1	MBD86421 BS1	6-20291
	453	Ribbed base	50	300	147	Cam lock BS1	MBD86421R BS1	6-20292
	453	Double base	200	300	147	Cam lock BS1	MBD86421D BS1	6-20293



## Multi-purpose containers MB with ribbed base

Ideal for handling heavy weight loads – also in automated facilities

[www.mybitobox.com](http://www.mybitobox.com)

Configure colours and logos online!

- High load capacities of up to 50 kg / 75 kg
- Containers are also available with hinged interlocking lid or with stacking rails
- Very low base deflection for use in automated bin storage facilities\*



### BITO-Plus

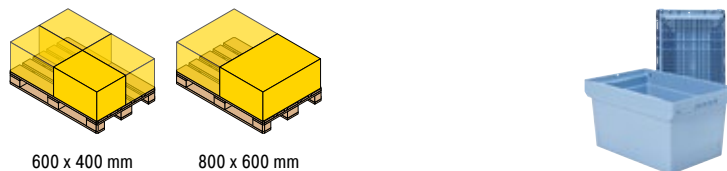
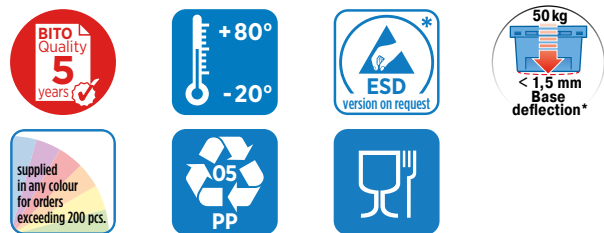

600 x 400 mm

800 x 600 mm

### BITO info

\*All values assume an ambient temperature of 23°C, long side-on container handling and uniformly distributed loads.

External dimensions L x W	Height	Volume	Load capacity	Bin type	Ref. no.
mm	mm	litres	kg		
600 x 400	241	38	50	MB64221R	6-17601
	341	58	50	MB64321R	6-17558
	441	74	50	MB64421R	6-17603
800 x 600	323	114	75	MB86321R	6-15247
	423	151	75	MB86421R	6-15256



### With hinged stacking seats

External dimensions L x W	Height	Volume	Load capacity	Stacking load	Bin type	Ref. no.
mm	mm	litres	kg	kg		
800 x 600	353	109	75	200	MBB86321R	6-15253
	453	147	75	200	MBB86421R	6-15262



### With hinged two-part lid

External dimensions L x W	Height	Volume	Load capacity	Stacking load	Bin type	Ref. no.
mm	mm	litres	kg	kg		
800 x 600	353	109	75	300	MBD86321R	6-15250
	453	147	75	300	MBD86421R	6-15259

## Multi-purpose containers MB with double base

Ideal for handling heavy weight loads – also in automated facilities

**i** [www.mybitobox.com](http://www.mybitobox.com)

Configure colours and logos online!

- Containers with a double base are very quiet in operation on conveyor systems, very sturdy and easy to clean
- High load capacities of up to 75 kg / 200 kg
- Very low base deflection for use in automated bin storage facilities\*
- Containers are also available with hinged interlocking lid or with stacking rails



### BITO-Plus

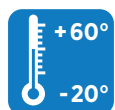

### **i** BITO info

\*All values assume an ambient temperature of 23°C, long side-on container handling and uniformly distributed loads.

**Please note: Some light barrier systems do not recognise bins with a black base. We are happy to offer bins with the base in the same colour as the bin.**

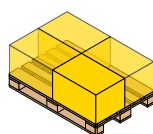

600 x 400 mm

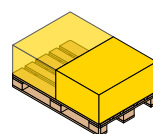

800 x 600 mm



External dimensions L x W <i>mm</i>	Height <i>mm</i>	Volume <i>litres</i>	Load capacity <i>kg</i>	Bin type	Ref. no.
600 x 400	242	38	75	MB64221D	6-17605
	342	58	75	MB64321D	6-17559
	442	74	75	MB64421D	6-17607
800 x 600	323	114	200	MB86321D	6-15248
	423	151	200	MB86421D	6-15257

### With hinged stacking seats

External dimensions L x W <i>mm</i>	Height <i>mm</i>	Volume <i>litres</i>	Load capacity <i>kg</i>	Stacking load <i>kg</i>	Bin type	Ref. no.
800 x 600	353	109	200	200	MBB86321D	6-15254
	453	147	200	200	MBB86421D	6-15263



### With hinged two-part lid

External dimensions L x W <i>mm</i>	Height <i>mm</i>	Volume <i>litres</i>	Load capacity <i>kg</i>	Stacking load <i>kg</i>	Bin type	Ref. no.
800 x 600	353	109	200	300	MBD86321D	6-15251
	453	147	200	300	MBD86421D	6-15260



### Multi-purpose containers MB Food & Delivery

- Helps last mile logistics to provide best grocery home delivery services
- “cool” solution consisting of bins, thermo insert box(es) in modular sizes, cool packs and dividers
- Ideally adapted to the dimensions of food packaging
- With notches on the long sides for fixing bag handles
- Suitably sized cool packs for chilled products and frozen foods can also be used as dividers
- Optionally available with stacking rails or with a hinged lid

NESTING AND FOLDING CONTAINERS



Thermo boxes: full-height option or half-height option for creating different temperature zones within the same container

### Equipment options

with notches on the long sides for fixing bag handles



perforated sides upon request



solid sides with/without stacking rails

without notches on the long sides for fixing bag handles



solid/perforated sides with/without stacking rails



solid/perforated sides with hinged two-part lid



## Multi-purpose containers MB Food &amp; Delivery, with perforated sides

External dimensions L x W <i>mm</i>	Features	Stacking Rails / lid	Height <i>mm</i>	Volume <i>litres</i>	Load capacity <i>kg</i>	Stacking load <i>kg</i>	Colour	Bin type	Ref. no.
600 x 400	sides with bag holder notches	---	373	67	25	140	lime green	MBEC64372-B3	79-51065
	sides with bag holder notches	with stacking rails	373	67	25	140	lime green	MBBEC64372-B3	79-51071
	without notches for bags	---	373	67	25	140	lime green	MBEC64372	79-51060
	without notches for bags	with stacking rails	373	67	25	140	lime green	MBBEC64372	79-51072



## Multi-purpose containers MB Food &amp; Delivery, with solid sides

External dimensions L x W <i>mm</i>	Features	Stacking rails / lid	Height <i>mm</i>	Volume <i>litres</i>	Load capacity <i>kg</i>	Stacking load <i>kg</i>	Colour	Bin type	Ref. no.
600 x 400	sides with bag holder notches	---	373	67	28	160	lime green	MBEC64371-B3	79-51062
	without notches for bags	---	373	67	28	160	dove blue	MBEC64371	79-51059
	without notches for bags	with stacking rails	373	67	28	160	dove blue	MBBEC64371	79-51074
610 x 400	without notches for bags	with lid	390	67	28	160	dove blue	MBDEC64371	79-51075



## Thermo boxes for chilled and frozen products

Format	External dimensions L x W x H <i>mm</i>	Material	Volume <i>litres</i>	Bin type	Ref. no.
size 2 / full volume	528 x 358 x 352	EPP	35	MBIE6437-2	79-51057
size 3 / ½ volume	358 x 263 x 352	EPP	15	MBIE6437-3	79-51058
perforated dividers	298 x 25 x 294	EPP		MBIE-QT64371-23	79-51050

## Cold packs

Description	External dimensions L x W x H <i>mm</i>	Weight <i>kg</i>	Suited for	Colour	Bin type	Ref. no.
suited for -3°C	296 x 25 x 294	1,8	chilled products	white	MBIE-A6437F-23	79-51053
suited for -21°C	296 x 25 x 294	1,8	frozen products	blue	MBIE-A6437TK-23	79-51054

## Accessories



A Security seals



B Barcoded security seals



C Drop-on lid



D Transport dollies



## BITO PharmaBOX

### High-performance packaging for temperature-controlled transport

Safe storage and temperature-controlled shipping throughout the medical and pharmaceutical supply chain is vital to the success of treatments. This is why great care must be taken when it comes to replenishing the stocks of hospitals, GP surgeries and pharmacies with healthcare and pharmaceutical products.

## PharmaBOX

We have developed a passive cold chain packaging solution based on our successful MB distribution container range.

This solution enables safe shipping of temperature-sensitive goods such as vaccines and medicines over long periods of time (up to 80 hours) during which a specified temperature is held.

- **Shipping kit for products requiring temperature control in compliance with GDP regulations - consisting of a thermo box, data logger, digital seal and cloud connection**
- **Validated for QM systems in compliance with the relevant standards**
- **Recording and real-time tracking of temperature, humidity, vibration and location**
- **Archive & alarm function through the cloud**
- **Automated generation of transport protocols**
- **Automated reading of SmartBeacons (data loggers) and data transmission to the cloud**



NESTING AND FOLDING CONTAINERS



The new requirements of article § 17(2A)1 ApBetrO stipulate that proof of compliance with temperature profiles is mandatory. The starter set is the easiest and quickest way to guarantee that temperature requirements are observed and recorded automatically.



For detailed information, please visit our website on <https://www.bitto.com/de-de/fachwissen/artikel/besonderheiten-der-pharmalogistik/>

External dimensions L x W	Height	Volume	Load capacity	Stacking load	Number of cool packs	Description	Bin type	Ref. no.
mm	mm	litres	kg	kg				
410 x 300	340	4	25		4 (1 x PCM-Set)	with hinged two-part lid	MBD43321HP	77-51178
	340	4	25		4 (1 x PCM-Set)	with a two-piece hinged lid, including a cut-out for integrating a SmartHub/SmartLock	MBDSH43321	77-51174
610 x 400	340	15	35	200	8 (2 x PCM-Set)	with hinged two-part lid	MBD64321HP	77-51177
	340	15	35	200	8 (2 x PCM-Set)	with a two-piece hinged lid, including a cut-out for integrating a SmartHub/SmartLock	MBDSH64321	77-51173

## Accessories



A TempBeacon data logger



B SmartHub



C Pt100 4-wire dry ice sensor

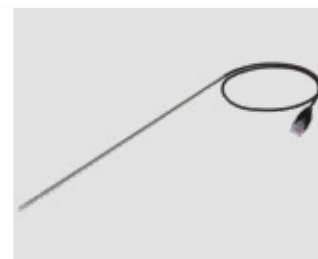

D Pt100 4-wire liquid nitrogen sensor (LN2)



E Cold pack PCM 4°C - 700 ml

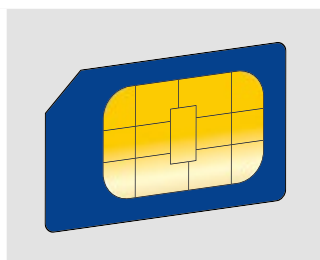

F Data tariff europe-wide SmartHub/SmartLock



G USB power adaptor / Type C charging cable



H Barcoded security seals

Pos.	Description		Dimensions <i>mm</i>	Product type	Pcs/ pack	Ref. no.
A	TempBeacon data logger	intelligent temperature and humidity data logger (recording intervals from 1-360 minutes), data can be read out manually using the app or automatically with the SmartHub gateway, multipurpose sensor that can be used multiple times for different shipments, factory calibrated, supplied with a battery life of 1 year, IATA-compliant, can be used in aircrafts	L 88 x W 45 x H 16	TB001	1	77-51235
B	SmartHub Alkaline, gateway monitoring system	SmartHub Alkaline without Lock function	L 129 x W 129 x H 29		1	77-51270
	SmartHub, gateway monitoring system	SmartHub Standard without Lock function	L 129 x W 129 x H 29		1	77-51269
	SmartLock, gateway monitoring system	SmartHub with SmartLock function for locking the lid of multipurpose containers MB	L 129 x W 129 x H 35		1	77-51268
C	Pt100 4-wire dry ice sensor	compatible with CryoBeacon, suited for a temperature range from -80°C to +200°C, cable length 900 mm, diameter 3 mm, sleeve 300 mm	-		1	77-51272
D	Pt100 4-wire liquid nitrogen sensor (LN2)	suited for a temperature range from -80°C to +200°C, cable length 500 mm/ diameter 3 mm/sleeve 300 mm/RJ-45 plug	-		1	77-51273
E	Cold pack PCM +15°C bis +25°C - 700 ml, set of 4 pcs	flexible use in both PharmaBOX sizes (400x300 mm and 600x400 mm), runtime extension of the PharmaBOX 600x400 mm by using additional battery sets - individual runtimes, safe temperature controlled shipping, reusable, easy to use and to handle, no marking as a hazardous substance required	L 210 x W 135 x H 30		4	77-51358
	Cold pack PCM -15°C bis -25°C - 700 ml, set of 4 pcs		L 210 x W 135 x H 30		4	77-51357
	Cold pack PCM 4°C - 700 ml, set of 4 pcs		L 210 x W 135 x H 30		4	77-51181
F	Data tariff europe-wide SmartHub/SmartLock		-		1	77-51361
	Data tariff worldwide SmartHub/SmartLock		-		1	77-51360
G	USB Power adapter, 12 W	Power supply 12W	-		1	77-51278
	USB Type C charging cable, angled version	charging cable 1.8 m long	L 1800		1	77-51318
	USB Type C charging cable, straight version		L 1800		1	77-51277
H	Barcoded security seals, MBP3 - for MB containers in all sizes and XL containers 800 x 600 mm	single use security seals with consecutive 8-digit numbering (barcode/human-readable format), seals are supplied tied together in pairs with identical numbering, the BITO Smartphone app "Seal + Track" makes reading and transmitting seal numbers easy, custom prints upon request	-	MBP32L	250	6-31550

## Multi-purpose containers MB for pharmaceutical supply chains

### Thermo insulation sets

Safe and reliable shipping of temperature-sensitive products

- Ideal for shipping temperature-sensitive products: pharmaceuticals, vaccines etc.
- Designed to minimise transport damage or product spoilage
- Kit includes 1 Neopor® box with lid – suitable for multi-purpose containers MBD43271 and MBD64271, 1 washable inlay from PS and 3 cool packs per inlay
- Keep products within a temperature range of 2-8 °C for at least 12 hours

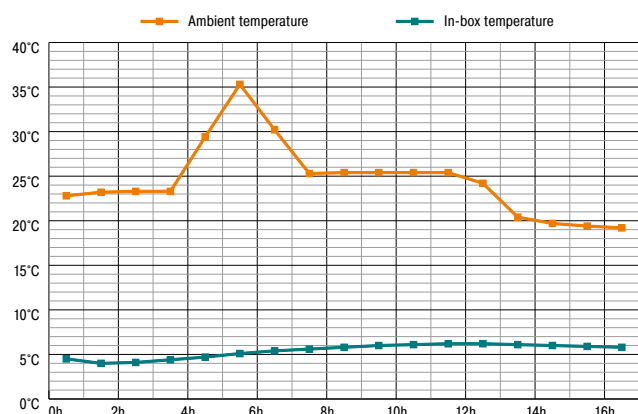

Summer temperature profile inside thermo insulation set

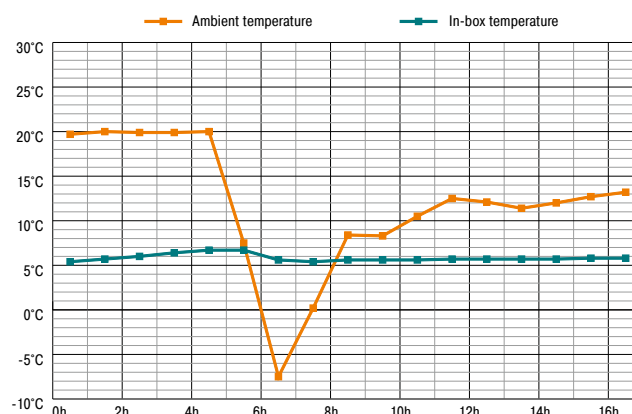

Winter temperature profile inside thermo insulation set

### **i** BITO info

At a constant outside temperature of 20°C, two cool packs are sufficient to keep in-box temperatures between 2°C and 8°C. These temperatures are kept for at least 12 hours in multi-purpose containers MBD43271 and for at least 8 hours in multi-purpose containers MBD64271. Temperature curves shown here are for illustration purposes only. More information on [www.bitto.com/downloads](http://www.bitto.com/downloads).

### Thermo insulation sets, for multi-purpose containers MB

Description	Accepts bin type	Dimensions W x H x D <i>mm</i>	Useable volume <i>litres</i>	Ref. no.
Thermo insulation sets	MBD43271	170 x 170 x 170	5	77-31363
	MBD64271	360 x 260 x 160	17	77-31364

Accessories		Dimensions <i>mm</i>	Product type	Pcs/pack	Ref. no.
Cold packs	insulation layer (2 mm thick) to prevent cold packs from sticking together, dimensions refer to unfrozen cold packs, maximum dimensional stability during freezing	L 195 x W 130 x H 23	Typ 4327	1	6-31361
		L 280 x W 190 x H 30	Typ 6427	1	6-31362
Replacement lid	from Neopor®, ergonomically optimised hand cups	L 340 x W 259 x H 50	Typ 4327	1	6-31440
		L 528 x W 358 x H 60	Typ 6427	1	6-31441
Thermo insert boxes	washable insert from polystyrene (PS)	-	Typ 4327	1	6-31359
		-	Typ 6427	1	6-31360

## Multi-purpose containers MB for pharmaceutical supply chains

### Thermo inlays

Innovative packaging solution for temperature sensitive goods

- Foldable thermal insulation set, available in 2 sizes
- Protect your goods against strong temperature fluctuations
- Cool packs keep the inside temperature at an even level
- Container inlays are also nestable
- Delivery includes cool packs



### Thermo inlays, for multi-purpose containers MB

Description	Accepts bin type	Number of cool packs	Ref. no.
Thermo inlays	MBD43271	2	77-22689
	MBD64271	4	77-22688





## Multi-purpose containers MB

### transparent version

Perfect product visibility

- Container from transparent polypropylene
- Perfect for transport, order picking and storage



#### BITO-Plus

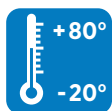

External dimensions L x W	Height	Volume	Load capacity	Bin type	Ref. no.
<i>mm</i>	<i>mm</i>	<i>litres</i>	<i>kg</i>		
400 x 300	223	18	20	MB43221TRANSP	6-18956
600 x 400	223	38	30	MB64221TRANSP	6-18957
	323	58	35	MB64321TRANSP	6-18958

### Transparent version, with stacking rails

External dimensions L x W	Height	Volume	Load capacity	Stacking load	Bin type	Ref. no.
<i>mm</i>	<i>mm</i>	<i>litres</i>	<i>kg</i>	<i>kg</i>		
400 x 300	223	18	20	150	MBB43221TRANSP	6-18964
600 x 400	223	38	30	200	MBB64221TRANSP	6-18965
	323	58	35	200	MBB64321TRANSP	6-18966

### Transparent version, with hinged two-part lid

External dimensions L x W	Height	Volume	Load capacity	Stacking load	Bin type	Ref. no.
<i>mm</i>	<i>mm</i>	<i>litres</i>	<i>kg</i>	<i>kg</i>		
410 x 300	240	18	20	150	MBD43221TRANSP	6-18961
610 x 400	240	38	30	200	MBD64221TRANSP	6-18962
	340	58	35	200	MBD64321TRANSP	6-18963

## Multi-purpose containers MB

### for hazardous substances, drop-on lid with metal snap locks

Safe transport of hazardous goods such as paints, sprays, etc.

- MB containers for hazardous substances come with drop-on lids complete with ready-mounted metal lever locks
- MB containers have been approved by the Bundesanstalt für Materialforschung und -prüfung (German Federal Institute for Materials Research and Testing) as outer packaging for hazardous goods categorised into packing groups II and III.
- All containers bear the approval number 4H2/Y25/S/23/D/BAM6107-BITO
- Colour: purple red



External dimensions L x W	Height	Volume	Load capacity	Bin type	Ref. no.
<i>mm</i>	<i>mm</i>	<i>litres</i>	<i>kg</i>		
410 x 310	238	18	13	MBSG43221CLIP	6-18653
	338	27	13	MBSG43321CLIP	6-18655
610 x 410	238	38	17	MBSG64221CLIP	6-18657
	338	58	20	MBSG64321CLIP	6-18659
	438	74	20	MBSG64421CLIP	6-18660

## Multi-purpose containers MB

with view and pick opening

Ideal for garments...

- Containers are also available with hinged interlocking lid or with stacking rails

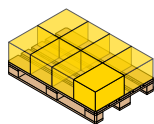

400 x 300 mm

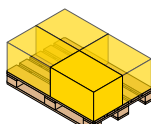

600 x 400 mm

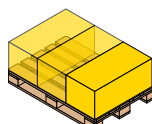

800 x 600 mm

External dimensions L x W <i>mm</i>	Height <i>mm</i>	Pick opening W x H <i>mm</i>		Volume <i>litres</i>	Load capacity <i>kg</i>	Bin type	Ref. no.
400 x 300	273	182 x 138	on short side	22	25	MB43274	6-5024
	323	182 x 157	on short side	27	25	MB43324	6-5025
600 x 400	223	117 x 439	on long side	38	30	MB64226	6-11083
		270 x 117	on short side	38	30	MB64224	6-11086
	273	139 x 439	on long side	47	30	MB64276	6-11082
		270 x 139	on short side	47	30	MB64274	6-11085
	323	158 x 439	on long side	58	35	MB64326	6-10804
		270 x 158	on short side	58	35	MB64324	6-10803
	423	217 x 439	on long side	74	35	MB64426	6-11081
		270 x 217	on short side	74	35	MB64424	6-11084
800 x 400	323	270 x 158	on short side	76	35	MB84324	6-5047
	423	270 x 217	on short side	100	35	MB84424	6-5048

## Multi-purpose containers MB - Mail custom solution

with hinged two-part lid

Officially approved for use by German post offices and postal services

- These MB containers have been especially developed for mail sorting centres and have been approved by the Deutsche Post AG (German Mail) for use on conveyors.
- Single use security seals safely lock containers with hinged lid and protect integrity of contents

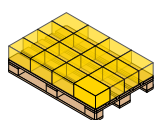

310 x 200 mm

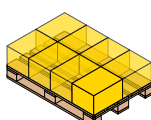

410 x 300 mm

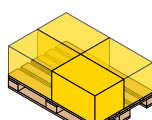

610 x 400 mm



With hinged two-part lid

External dimensions L x W <i>mm</i>	Height <i>mm</i>	Volume <i>litres</i>	Load capacity <i>kg</i>	Bin type	Ref. no.
310 x 200	170	5	15	MBD32151POST	6-17269
410 x 300	240	18	20	MBD43221POST	6-17264
	290	22	25	MBD43271POST	6-17265
610 x 400	290	47	30	MBD64271POST	6-17267
	340	58	35	MBD64321POST	6-17268

### Multi-purpose containers MB Eco

Multi-purpose containers MB Eco, recycled material

Your first choice for stacking and nesting: BITOBOX MB

- Stack safely and save space when nested
- MB container body made from recycled polypropylene from BITO bins
- Hinged lids can be supplied in five colour options



#### BITO-Plus

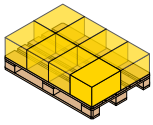

400 x 300 mm

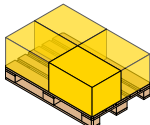

600 x 400 mm

#### **i** BITO info

Slight colour variations can occur when using recycled materials.

NESTING AND FOLDING CONTAINERS





### Multi-purpose containers MB Eco, standard version, without push bar, without lid

External dimensions L x W	Height	Volume	Load capacity	Bin type	Ref. no.
<i>mm</i>	<i>mm</i>	<i>litres</i>	<i>kg</i>		
400 x 300	223	18	18	MB43221Eco	C0401-0088
600 x 400	223	38	27	MB64221Eco	C0401-0201
	323	58	31	MB64321Eco	C0401-0087



### Multi-purpose containers MB Eco, with mounted stacking rails

External dimensions L x W	Height	Volume	Load capacity	Stacking load	Bin type	Ref. no.
<i>mm</i>	<i>mm</i>	<i>litres</i>	<i>kg</i>	<i>kg</i>		
400 x 300	223	27	25	135	MBB43221Eco	C0402-0418
600 x 400	223	38	30	180	MBB64221Eco	C0402-0419
	323	58	35	180	MBB64321Eco	C0402-0420



### Multi-purpose containers MB Eco, with hinged two-part lid

External dimensions L x W x H	Volume	Load capacity	Stacking load	Bin type	Lid colour	Ref. no.
<i>mm</i>	<i>litres</i>	<i>kg</i>	<i>kg</i>			
410 x 300 x 240	18	18	135	MBD43221Eco	Black	C0402-0425
					Blue	C0402-0428
					Red	C0402-0426
					Green	C0402-0427
					Yellow	C0402-0429
610 x 400 x 240	38	27	180	MBD64221Eco	Black	C0402-0430
					Blue	C0402-0433
					Red	C0402-0431
					Green	C0402-0432
					Yellow	C0402-0434
610 x 400 x 340	58	31		MBD64321Eco	Black	C0402-0435
					Blue	C0402-0438
					Red	C0402-0436
					Green	C0402-0437
					Yellow	C0402-0439



### Accessories



A Security seals



B Security seals



C Security seals



D Barcoded security seals



E Locking clips



F Easy peel label holders



G Document pockets



H Document pockets



I Drop-on lid



J Transport dollies



K Transport dollies



L Multi-purpose containers MB „Mobile Office“



M Rails for A4 hanging files



N Connector clips

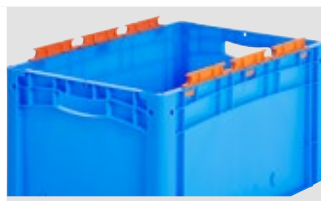

O Sides with bag holder notches



P Multi-trip transport solution for bins and containers



#### Increased product protection: Barcoded security seals for BITO MB containers

Security seals MBP-32, white, consecutive 8-digit numbering (barcode and human-readable), seals are supplied tied together in pairs with identical numbering. Convenient data capture and transmission of seal numbers with the BITO smartphone app "Seal & Track". More info on [www.bitto.com](http://www.bitto.com). Custom prints upon request.

NESTING AND FOLDING CONTAINERS

Pos.	Description		Dimensions <i>mm</i>	Product type	Pcs/ pack	Ref. no.
A	Security seals, MBP1 - suited for BITOBOX MB	single use security seals, suited for all MB and XL containers sized 800 x 600 mm at the base, prevent tampering and opportunistic theft, 2 security seals required per container, colour: red, other colours upon request	-	MBP1	500	6-10810
B	Security seals, MBP2 - suited for BITOBOX MB	single use security seals, suited for all MB and XL containers sized 800 x 600 mm at the base, prevent tampering and opportunistic theft, 2 security seals required per container, colour: red, customised marking and colours on request	-	MBP2	500	6-15705
C	Security seals, MBP2-L - suited for BITOBOX MB, XL, SL	single use security seals with continuous numbering, suited for all MB, SL and XL containers sized 800 x 600 mm, colour: red	-	MBP2-L	500	6-19162
D	Barcoded security seals, MBP3 - suited for BITOBOX MBs in all sizes and XLs 800 x 600 mm	single use security seals with consecutive 8-digit numbering (barcode/human-readable format), seals are supplied tied together in pairs with identical numbering, the BITO Smartphone app "Seal + Track" makes reading and transmitting seal numbers easy, custom prints upon request	-	MBP32L	250	6-31550
E	Locking clips, suited for BITOBOX MB	used to lock MB containers with a hinged lid, can be re-used, colour: red	-	MBV	10	6-20299
F	Easy peel label holders, KFA6	self-adhesive carrier foil for easy removal of stick-on labels from bin and container surfaces	L 165 x W 114	KFA6	100	6-31309
	Easy peel label holders, KFA5		L 230 x W 170	KFA5	100	6-31310
G	Document pockets, self-adhesive 3 sides open	ideal for frequent exchange of inserts, adhesive fabric backing provides strong adhesion, colour transparent	L 175 x W 105	MBET	10	6-5031
			L 210 x W 75	MBETVDA	10	6-31311
			L 210 x W 150	MBETDINA5	10	6-19528
H	Document pockets, self-adhesive 2 sides open	slightly shorter ticket holder front allows to easily insert and remove cards, Material vinyl, colour blue	L 145 x W 100	46-21108	25	46-21108
	Document pockets, self-adhesive 1 side open	document pocket with two self-adhesive strips, also suited for location marking on shelving and racking, durable adherence to all types of storage/transport bins and shelving/racking, Material vinyl, colour blue	L 155 x W 85 L 235 x W 170	46-21109 46-21110	25 25	46-21109 46-21110
I	Drop-on lid, for multi-purpose containers MB	will cover MB container stacks, can also be used to close individual containers, suited for automated lidding and strap-sealing, individual lids can be nested to save on space, adds 10 mm to container height on all sides	L 306 x W 206	MBS32	1	6-15868
			L 400 x W 300	MBSU43	1	6-30277
			L 600 x W 400	MBSU64	1	6-30276
			L 800 x W 400	MBS84	1	6-22544
			L 800 x W 600	MBS86	1	6-22546
J	Transport dollies, for multi-purpose containers sized 600 x 400 mm	complete with 4 swivel castors, for multi-purpose containers sized 600 x 400 mm, fitted with drop-in lid for optimum positioning of MB containers, made from glassfibre reinforced polyamide, drop-in lid from polypropylene	L 620 x W 420	TR64MBS	1	6-15510
K	Aluminium transport dollies TR64MB, for multi-purpose containers sized 600 x 400 mm	complete with 4 swivel castors, for multi-purpose containers sized 600 x 400 mm, anodised aluminium frame with PVC corner edging, supplied unassembled	L 620 x W 420	6-51262	1	6-51262
	Transport dollies, for multi-purpose containers sized 800 x 400 mm and 800 x 600 mm	complete with 4 swivel castors, for multi-purpose containers sized 800 x 400 mm and 800 x 600 mm, anodised aluminium frame with PVC corner edging, supplied unassembled	L 720 x W 370	TR84MB	1	6-16494
			L 720 x W 540	TR86MB	1	6-19439
L	Multi-purpose containers MB "Mobile Office", including rails for A4 hanging files	safe transport and storage of hanging files, 2 rails for hanging files per container, to be fitted inside, easy assembly	L 610 x W 400 x H 340	6-12938	1	6-12938
M	Rails for A4 hanging files, for multi-purpose containers MB	2 file rails can be fitted inside the container for safe storage and transport of A4 hanging files. Additionally, the container contents can be secured by a hinged lid or a drop-on lid and security seals. File rails can only be fitted to containers MB(D)64321 and MB(D)64421.	-	MBE64	Paar	6-11920
N	Connector clips	The connector clip allows to form a double-height transport unit by joining multi-purpose containers face to face. Containers to be joined must have the same length and width, but may differ in height.	-	MBC	100	6-15625
O	Sides with bag holder notches, demountable	clip-on fitting to MB, XL and KLT containers, practical for keeping bags open for easy filling, can be retro-fitted, can be removed, colour: grey (photo shows test colour)	-	MB-BR64D	1	6-31553
P	Multi-trip transport solution for bins and containers	can be moved without hand pallet truck or forklift truck standard dimensions of 800 x 600 mm (1/2 Euro pallet), More information on page 126	-			



### Multi-purpose containers MB - special applications

#### Designed for your special applications

Benefit from utmost versatility: MB containers are just as useful in in-house transport and intralogistics in the widest sense as they are for shipping. This also means that MB containers must be able to cater for custom requirements. For this purpose, BITO provides the widest possible spectrum of features to make your MB container perfect for your needs. Automated barcode labelling or milling and drilling holes to comply with fire prevention regulations are just a few examples.

Of course, we also supply containers with company logos and messages, special dimensions, customised inlays and reinforcing features.

#### BITOBOX MB

##### Equipments options



MB with foam inlay, reflective foil and specifically designed label holder.



Special size MB for extra long items – designed to your specifications!



MB used for logistics services by TNT, an internationally operating CEP service provider.



MB with specially designed label holder. Label can only be removed when container is open.



MB used as freight box by the German air carrier Lufthansa.



MB with drainage holes used for storage.

NESTING AND FOLDING CONTAINERS





## Easy peel label holders

- Self-adhesive carrier foil for easy removal of stick-on labels from bin and container surfaces



Dimensions	Format	Product type	Pcs/pack	Ref. no.
<i>mm</i>				
L 165 x W 114	DIN A6	KFA6	100	6-31309
L 230 x W 170	DIN A5	KFA5	100	6-31310



NESTING AND FOLDING CONTAINERS



**Folding boxes EQ**

## The next generation of folding boxes

Compared to folding boxes of other manufacturers, the BITO folding box EQ features a revolutionary, ergonomically designed and easy to handle folding mechanism.



NESTING AND FOLDING CONTAINERS



NESTING AND FOLDING CONTAINERS

[www.mybitobox.com](http://www.mybitobox.com)  
Configure colours and logos online!

**BITOBOX EQ**

## Product features



### Seesaw (un-)locking profile

Sides lock open with a simple push of the thumb or the heel of the hand on the box shoulder. Developed in cooperation with leading ergonomists.



### Fold-up handles

This alternative to open handle grips prevents unauthorized access to the contents and allows full use of the bin volume as well as easy handling.

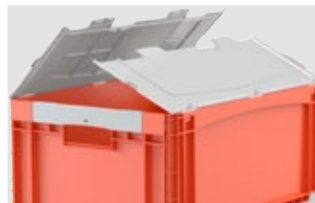

### Hinged interlocking lids (optional)

loss-proof, tamper evident security seals available



### Label holder (optional)

The clear-view label holder can be fitted on the short side or on the lid. Please specify.

## Folding boxes EQ

The folding box that really improves workplace ergonomics!

- **Robust make withstands many distribution cycles**
- **Empty containers fold flat to save valuable space during storage and transport**
- **Space saving ratio 1:4**
- **The ribbed base and double base versions are also suited for automated storage**
- **Also available with hinged two-part lid suited for security sealing**



### BITO-Plus

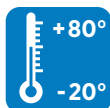

**i** [www.mybitobox.com](http://www.mybitobox.com)

Configure colours and logos online!

### With standard base

- Ergonomic handling
- Sides fold safely in seconds without jamming
- Save 75% of storage volume when folded



External dimensions L x W <i>mm</i>	Height <i>mm</i>	Description	Load capacity <i>kg</i>	Stacking load <i>kg</i>	Volume <i>litres</i>	Bin type	Ref. no.	Ref. no.
600 x 400	285	with fold-up handles	20	180	58,0	EQ64281L	51-31454	51-31470
	285	with grip opening	20	180	58,0	EQ64281	51-31452	51-31468
	320	with fold-up handles	20	180	65,0	EQ64321L	51-31455	51-31471
	320	with grip opening	20	180	65,0	EQ64321	51-31453	51-31469



### With standard base and hinged two-part lid

External dimensions L x W <i>mm</i>	Height <i>mm</i>	Description	Load capacity <i>kg</i>	Stacking load <i>kg</i>	Volume <i>litres</i>	Bin type	Ref. no.	Ref. no.
600 x 400	297	with fold-up handles	20	180	57,0	EQD64281L	51-31458	51-31474
	297	with grip opening	20	180	57,0	EQD64281	51-31456	51-31472
	332	with fold-up handles	20	180	64,0	EQD64321L	51-31459	51-31475
	332	with grip opening	20	180	64,0	EQD64321	51-31457	51-31473





## with ribbed base and with hinged two-part lid

External dimensions L x W <i>mm</i>	Height <i>mm</i>	Description	Load capacity <i>kg</i>	Stacking load <i>kg</i>	Volume <i>litres</i>	Bin type	Ref. no.	Ref. no.
600 x 400	297	with fold-up handles	50	180	54,0	EQD64281LR	51-31466	51-31482
	297	with grip opening	50	180	54,0	EQD64281R	51-31464	51-31480
	332	with fold-up handles	50	180	61,0	EQD64321LR	51-31467	51-31483
	332	with grip opening	50	180	61,0	EQD64321R	51-31465	51-31481



## With ribbed base

External dimensions L x W <i>mm</i>	Height <i>mm</i>	Description	Load capacity <i>kg</i>	Stacking load <i>kg</i>	Volume <i>litres</i>	Bin type	Ref. no.	Ref. no.
600 x 400	285	with fold-up handles	50	180	55,0	EQ64281LR	51-31462	51-31478
	285	with grip opening	50	180	55,0	EQ64281R	51-31460	51-31476
	320	with fold-up handles	50	180	62,0	EQ64321LR	51-31463	51-31479
	320	with grip opening	50	180	62,0	EQ64321R	51-31461	51-31477

## Accessories



**A** Security seals



**B** Drop-on lids



**C** Transport dollies



**D** Document pockets



**E** Multi-trip transport solution for bins and containers

Pos.	Description	Colour	Material	Pcs/pack	Ref. no.
<b>A</b>	Security seals with laser marking single use security seals fit all EQ folding boxes, seals are supplied tied together in pairs with identical numbering, consecutive laser-applied numbering (barcode)	white	PP	250	51-31666
<b>B</b>	Drop-on lids thermoformed lid from PS, protection from dust, the lid also fits on folded boxes; box + lid units can be stacked on top of one another	black	PS	1	51-31437
<b>C</b>	Transport dollies complete with 4 swivel castors, designed for European size stacking containers: 1 x 600 x 400 mm or 2 x 400 x 300 mm, framework from glassfibre reinforced polyamide	RAL 5007 Brilliant blue		1	43-1491
	Transport dollies - ESD version ABS frame in ESD version, black with four galvanized steel swivel castors with PP ESD wheel, Ø 100 mm, for transporting one European size stacking container 600 x 400 mm or two European size stacking containers 400 x 300 mm, supplied unassembled	black		1	43-51322
<b>D</b>	Document pockets ideal for frequent exchange of inserts, adhesive fabric backing provides strong adhesion, colour transparent	transparent	PE	10	6-5031
<b>E</b>	Multi-trip transport solution for bins and containers can be moved without hand pallet truck or forklift truck, standard dimensions of 800 x 600 mm (1/2 Euro pallet), More information on page 126				



## Folding distribution boxes MFB

Nesting saves up to 82% of storage volume

- **Folds safely in seconds**
- **Advanced design in 5 variations**



**BITO-Plus**

+80°  
-20°

ESD  
version on request

05  
PP



Vertical sides allow maximum volume utilisation



Optionally available with hinged two-part lid



Easy de-stacking



Robust hinges for a long service life



Safe stacking

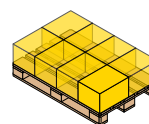

400 x 300 mm

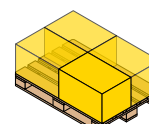

600 x 400 mm

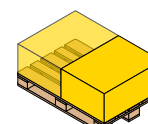

800 x 600 mm



External dimensions L x W	Height	Internal dimensions L x W x H	Volume	Folded height	Bin type	Ref. no.
mm	mm	mm	litres	mm		
400 x 300	220	370 x 270 x 215	22	65	MFB43221	7-22656
600 x 400	220	560 x 360 x 210	42	80	MFB64221	7-22657
	280	560 x 360 x 270	54	80	MFB64281	7-22658
	320	560 x 360 x 310	64	80	MFB64321	7-22659
800 x 600	220	740 x 540 x 175	70	130	MFB86221	7-51354
	320	740 x 540 x 275	110	130	MFB86321	7-51355
	445	740 x 540 x 425	165	125	MFB86441	7-22660



### With hinged two-part lid

External dimensions L x W	Height	Internal dimensions L x W x H	Volume	Folded height	Bin type	Ref. no.
mm	mm	mm	litres	mm		
400 x 300	220	370 x 270 x 215	22	65	MFBD43221	7-22661
600 x 400	230	560 x 360 x 210	42	90	MFBD64221	7-22662
	290	560 x 360 x 265	54	90	MFBD64281	7-22663
	330	560 x 360 x 310	64	90	MFBD64321	7-22664
800 x 600	465	740 x 540 x 425	165	145	MFBD86441	7-22665

## Accessories



**A** Security seals



**B** Safety clips

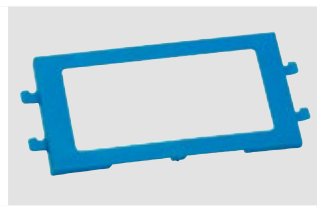

**C** Label frames

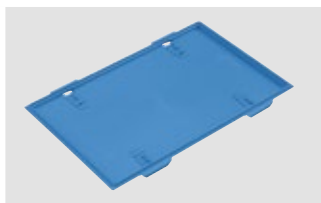

**D** Drop-on lids



**E** Transport dollies



**F** Transport dollies

Pos.	Description	Colour	Dimensions <i>mm</i>	Product type	Pcs/ pack	Ref. no.	
<b>A</b>	Security seals	tear-off security seals, suited for all MBF folding distribution boxes, custom prints available, colour: red	red	-	MFBP	100	7-22666
<b>B</b>	Safety clips	protection against theft, prevent short sides from being pushed open by external pressure	-	-	MFBS	1	7-22675
<b>C</b>	Label frames	ideal for accompanying documents, not suited for MFB(D)64221	dove blue	L 160 x W 80	MFBER80	1	7-22673
<b>D</b>	Drop-on lids	reliable protection against soiling	dove blue	L 400 x W 300	MFB-AD43	1	7-22670
			dove blue	L 600 x W 400	MFB-AD64	1	7-22671
			anthracite grey	L 800 x W 600	MFB-AD86	1	7-22672
<b>E</b>	Transport dollies	complete with 4 swivel castors, designed for European size stacking containers: 1 x 600 x 400 mm or 2 x 400 x 300 mm, framework from glassfibre reinforced polyamide	RAL 5007 Brilliant blue	L 620 x W 420	TR64	1	43-1491
	Transport dollies - ESD version	ABS frame in ESD version, black with four galvanized steel swivel castors with PP ESD wheel, Ø 100 mm, for transporting one European size stacking container 600 x 400 mm or two European size stacking containers 400 x 300 mm, supplied unassembled	black	L 620 x W 420	43-51322	1	43-51322
<b>F</b>	Transport dollies	supplied with 2 swivel and 2 fixed castors, suited for containers sized 800 x 600 mm, made from polypropylene	anthracite grey	L 800 x W 600 x H 198	RU86.125	1	43-1150



### Stack and nest containers U-Turn

The lightweight space giant

- **Stack – turn – nest**
- **Huge storage capacity**
- **Nesting saves more 64% on volume**
- **Extremely lightweight – yet very sturdy**



**BITO-Plus**

- BITO Quality 5 years
- ESD version on request
- supplied in any colour for orders exceeding 200 pcs.
- +80° / -20°

**i** [www.mybitobox.com](http://www.mybitobox.com)

Configure colours and logos online!

NESTING AND FOLDING CONTAINERS

### Features and benefits



**Approx. 20% more storage volume**  
than with stack and nest containers with sloped sides



**Foldable drop-on lid**  
saves transport costs, because folded lids can be placed in empty containers

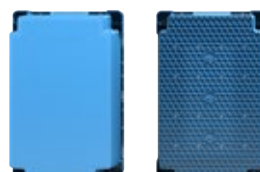

**Base variations for manual and automated warehousing**  
standard single-layer base, ribbed base, double base



**Colour selection**  
available in 4 colours as standard

External dimensions L x W	Height	Handle type	Base type	Colour	Bin type	Ref. no.
mm	mm					
600 x 400	320	grip opening	smooth, single-layer base	blue	DSB64321	C0501-0001
				green	DSB64321	C0501-0002
				red	DSB64321	C0501-0003
				grey	DSB64321	C0501-0004
		integrated pocket handles	Ribbed base	grey	DSB64321R	C0501-0005
			Double base	grey	DSB64321D	C0502-0001



## Accessories

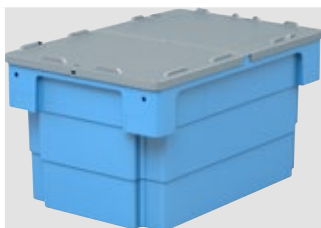

**A** Drop-on lid



**B** Security seals



**C** Barcoded security seals



**D** Transport dollies

Pos.	Description		Product type	Pcs/pack	Ref. no.
<b>A</b>	Drop-on lid	sized 600 x 400 mm, grey	DSBS64-F	1	78-51030
<b>B</b>	Security seals	prevents unauthorised access to contents, tear-off seal, perfectly adapted to the MB container series	MBP1	500	6-10810
<b>C</b>	Barcoded security seals	single use security seals with consecutive 8-digit numbering (barcode/human-readable format) seals are supplied tied together in pairs with identical numbering the BITO Smartphone app "Seal + Track" makes reading and transmitting seal numbers easy custom prints upon request	MBP32L	250	6-31550
<b>D</b>	Transport dollies	high-quality swivel castors with thread guard, excellent stability, suited for containers sized 600 x 400 mm	TR64	1	43-1491
		silent operation through rubber tyres, excellent stability, suited for containers sized 600 x 400 mm	TR64G	1	43-21883
	Transport dollies - ESD version	ABS frame in ESD version, black with four galvanized steel swivel castors with PP ESD wheel, Ø 100 mm, for transporting one European size stacking container 600 x 400 mm or two European size stacking containers 400 x 300 mm, supplied unassembled	-	1	43-51322
<b>E</b>	Multi-trip transport solution for bins and containers	can be moved without hand pallet truck or forklift truck, standard dimensions of 800 x 600 mm (1/2 Euro pallet), More information on page 126	-		



## Stack and nest containers DSL

Stackable and nestable container range in many sizes

- Containers are stackable and nestable with a front-to-back turn
- Containers sized 600 x 400 mm and 800 x 400 mm have open grips, all other container sizes come with moulded grips pockets
- Easy to clean
- Adapted to Euro pallet size
- Stacking load up to 150 kg
- Choice of 4 colours

**BITOBOX DSL**

**BITO-Plus**



### With solid sides

External dimensions L x W	Height	Internal dimensions L x W x H	Volume	Load capacity	Stacking load	Bin type	Ref. no.	Ref. no.	Ref. no.	Ref. no.
mm	mm	mm	litres	kg	kg					
300 x 200	150	215 x 145 x 145	6,0	5	150	DSL3215	7-14354	7-14416	7-14418	7-14417
400 x 280	180	290 x 210 x 176	13,0	10	150	DSL4318	7-14355	7-14419	7-14421	7-14420
590 x 380	135	440 x 290 x 130	18,0	15	150	DSL6413	7-14356			
	202	433 x 285 x 196	34,0	30	150	DSL6420	7-14357	7-14422	7-14424	7-14423
600 x 400	300	452 x 318 x 296	50,0	45	150	DSL6430	7-14358	7-14425	7-14427	7-14426
800 x 400	300	652 x 325 x 296	70,0	55	150	DSL8430	7-14359	7-14428	7-14430	7-14429

### Accessories



**A** Drop-on lid

Pos.	Description	To suit containers sized L x W	Product type	Ref. no.	
		mm			
<b>A</b>	Drop-on lid	reliable protection against soiling, excellent stacking capacity also applies for lidded containers, colour: grey, from polystyrene	590 x 380 600 x 400 800 x 400	DSD6420 DSD6430 DSD8430	7-14351 7-14352 7-14353

## Stack and nest containers DST

Stackable and nestable container range in many sizes

- Containers are stackable and nestable with a front-to-back turn
- Easy to clean
- Adapted to Euro pallet size
- Drop-on lid to fit (see accessories)



## With solid sides

- Suited for heavy duty applications
- Stacking load up to 350 kg
- Nesting saves up to 65% on volume
- Flat base guarantees optimum travel characteristics on conveyors

External dimensions L x W	Height	Internal dimensions L x W x H	Volume	Load capacity	Stacking load	Bin type	Ref. no.
mm	mm	mm	litres	kg	kg		
600 x 400	150	512 x 368 x 130	28	35	350	DSTG6415	7-20025
	200	512 x 368 x 180	36	35	350	DSTG6420	7-20026
	250	512 x 368 x 230	46	35	350	DSTG6425	7-20027
	300	512 x 368 x 280	56	50	350	DSTG6430	7-20028
	350	512 x 368 x 330	66	50	350	DSTG6435	7-20029
	400	512 x 368 x 380	76	50	350	DSTG6440	7-20030

## Accessories

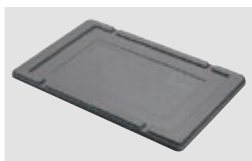

A Drop-on lid

Pos.	Description	To suit containers sized L x W	Product type	Ref. no.
		mm		
A	Drop-on lid	reliable protection against soiling	600 x 400	DSTD64 7-20037



## Multi-purpose containers MB

### Great for storing, handling and picking large sized goods!

All advantages of the successful MB container series also apply to MB containers with the base dimensions of 800x600 mm: they are very versatile in use, rigid for safe stacking during storage and save on valuable space when nested empty during transport. What makes them stand out compared to other large volume containers is the fact that optional runners can be added and that containers can be nested with fork entry shoes.

### BITOBOX MB

CONTAINERS WITH FORK ENTRY SHOES 800 X 600

#### Base options



**Standard base**  
Standard base for loads up to 50 kg

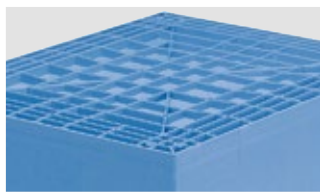

**Ribbed base**  
Ribbed base for loads up to 75 kg

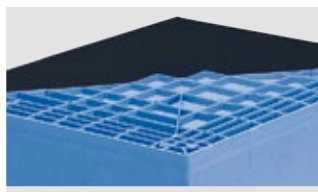

**Double base**  
Double base for loads up to 200 kg



**Water drainage holes**  
Optionally supplied with drainage holes. Contact us!

#### Product features



**Label cover**  
The integral label cover protects your address labels and address cards.



**Barcode/RFID labels**  
Slightly recessed label areas allow exact positioning of barcode labels and RFID labels.



**Adhesive labels**  
Dimpled areas allow easy positioning and removal of adhesive labels.



**Manual handling**  
Ergonomically designed, closed hand grips allow easy handling.



## Multi-purpose containers MB

with ready-mounted runners

Our large volume containers 800 x 600 mm are nestable even if fork entry shoes are mounted!

- 3 products in 1 - storage, order picking and transport
- First nestable container with fork entry shoes
- Nest to reduce volume for empty storage and transportation
- Ergonomic molded handgrips for easy handling



**BITO-Plus**

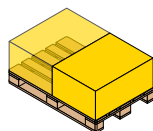

800 x 600 mm

### Multi-purpose containers MB with ribbed base, with ready-mounted runners

External dimensions L x W	Height	Volume	Load capacity	Bin type	Ref. no.
<i>mm</i>	<i>mm</i>	<i>litres</i>	<i>kg</i>		
800 x 600	323	114	75	MB86321RKUFE	6-15310
	523	151	75	MB86421RKUFE	6-15316



### Multi-purpose containers MB with ribbed base, with hinged stacking seats and fork entry shoes

External dimensions L x W	Height	Volume	Load capacity	Stacking load	Bin type	Ref. no.
<i>mm</i>	<i>mm</i>	<i>litres</i>	<i>kg</i>	<i>kg</i>		
800 x 600	453	109	75	200	MBB86321RKUFE	6-15314
	553	147	75	200	MBB86421RKUFE	6-15320



### Multi-purpose containers MB with ribbed base, with hinged interlocking lid and fork entry shoes

External dimensions L x W	Height	Volume	Load capacity	Stacking load	Bin type	Ref. no.
<i>mm</i>	<i>mm</i>	<i>litres</i>	<i>kg</i>	<i>kg</i>		
800 x 600	323	109	75	300	MBD86321RKUFE	6-15312
	523	147	75	300	MBD86421RKUFE	6-15318



CONTAINERS WITH FORK ENTRY SHOES 800 X 600



## Multi-purpose containers MB

with ready-mounted runners



### Multi-purpose containers MB with double base, with ready-mounted runners

External dimensions L x W	Height	Volume	Load capacity	Bin type	Ref. no.
<i>mm</i>	<i>mm</i>	<i>litres</i>	<i>kg</i>		
800 x 600	423	114	200	MB86321DKUFE	6-15311
	523	151	200	MB86421DKUFE	6-15317



### Multi-purpose containers MB with double base, with hinged stacking seats and fork entry shoes

External dimensions L x W	Height	Volume	Load capacity	Stacking load	Bin type	Ref. no.
<i>mm</i>	<i>mm</i>	<i>litres</i>	<i>kg</i>	<i>kg</i>		
800 x 600	453	109	200	200	MBB86321DKUFE	6-15315
	553	147	200	200	MBB86421DKUFE	6-15321



### With hinged interlocking lid and fork entry shoes

External dimensions L x W	Height	Volume	Load capacity	Stacking load	Bin type	Ref. no.
<i>mm</i>	<i>mm</i>	<i>litres</i>	<i>kg</i>	<i>kg</i>		
800 x 600	453	109	200	300	MBD86321DKUFE	6-15313
	553	147	200	300	MBD86421DKUFE	6-15319

CONTAINERS WITH FORK ENTRY SHOES 800 X 600

## Accessories



**A** Security seals



**B** Security seals



**C** Security seals



**D** Locking clips

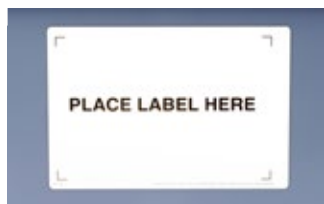

**E** Easy peel label holders



**F** Document pockets

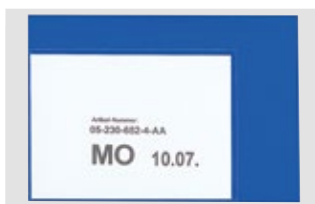

**G** Document pockets



**H** Document pockets



**I** Drop-on lid

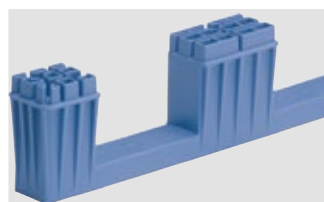

**J** Add-on fork entry shoes



**K** Barcoded security seals

Pos.	Description		Dimensions <i>mm</i>	Product type	Pcs/ pack	Ref. no.
<b>A</b>	Security seals, MBP1 - suited for BITOBOX MB	single use security seals, suited for all MB and XL containers sized 800 x 600 mm at the base, prevent tampering and opportunistic theft, 2 security seals required per container, colour: red, other colours upon request	-	MBP1	500	6-10810
<b>B</b>	Security seals, MBP2 - suited for BITOBOX MB	single use security seals, suited for all MB and XL containers sized 800 x 600 mm at the base, prevent tampering and opportunistic theft, 2 security seals required per container, colour: red, customised marking and colours on request	-	MBP2	500	6-15705
<b>C</b>	Security seals, MBP2-L - suited for BITOBOX MB, XL, SL	single use security seals with continuous numbering, suited for all MB, SL and XL containers sized 800 x 600 mm, colour: red	-	MBP2-L	500	6-19162
<b>D</b>	Locking clips, suited for BITOBOX MB	used to lock MB containers with a hinged lid, can be re-used, colour: red	-	MBV	10	6-20299
<b>E</b>	Easy peel label holders, KFA5	self-adhesive carrier foil for easy removal of stick-on labels from bin and container surfaces	L 230 x W 170	KFA5	100	6-31310
	Easy peel label holders, KFA6		L 165 x W 114	KFA6	100	6-31309
<b>F</b>	Document pockets, self-adhesive 3 sides open	ideal for frequent exchange of inserts, adhesive fabric backing provides strong adhesion, colour transparent	L 175 x W 105	MBET	10	6-5031
			L 210 x W 150	MBETDINA5	10	6-19528
		ideal for frequent exchange of inserts, adhesive fabric backing provides strong adhesion, Material PVC, colour transparent	L 210 x W 75	MBETVDA	10	6-31311
<b>G</b>	Document pockets, self-adhesive 2 sides open	slightly shorter ticket holder front allows to easily insert and remove cards, Material vinyl, colour blue	L 145 x W 100	46-21108	25	46-21108
<b>H</b>	Document pockets, self-adhesive 1 side open	document pocket with two self-adhesive strips, also suited for location marking on shelving and racking, durable adherence to all types of storage/transport bins and shelving/racking, Material vinyl, colour blue	L 155 x W 85	46-21109	25	46-21109
			L 235 x W 170	46-21110	25	46-21110
<b>I</b>	Drop-on lid, for multi-purpose containers MB	will cover MB container stacks, can also be used to close individual containers, suited for automated lidding and strap-sealing, individual lids can be nested to save on space, adds 10 mm to container height on all sides	L 800 x W 600	MBS86	1	6-22546
<b>J</b>	Add-on fork entry shoes, for multi-purpose containers MB	easy to mount and to remove, easy to retro-fit by bolt-on fitting to double base containers	L 800 x W 600	6-19330	1	6-19330
<b>K</b>	Barcoded security seals, MBP3 - suited for BITOBOX MBs in all sizes and XLs 800 x 600 mm	single use security seals with consecutive 8-digit numbering (barcode/human-readable format), seals are supplied tied together in pairs with identical numbering, the BITO Smartphone app „Seal + Track“ makes reading and transmitting seal numbers easy, custom prints upon request	-	MBP32L	250	6-31550



CONTAINERS WITH FORK ENTRY SHOES 800 X 600

**European size stacking containers XL**

**Hardwearing, yet lightweight and manageable in size!**

Heavyweight metal containers that are still being used in many sectors are hard to reconcile with the demands of modern production methods. Time has come for organising processes in line with LEAN PRODUCTION principles. Lightweight, yet robust, BITO XL containers with a base dimension of 800x600 mm and various height options perfectly meet the demands of decreasing batch sizes.

**BITOBOX XL**



**1 base dimension - 5 height options to suit most needs**



120 mm



220 mm



320 mm



420 mm



520 mm



CONTAINERS WITH FORK ENTRY SHOES 800 X 600

## European size stacking containers XL with double base with ready-mounted runners

Safe, clean and strong – a valuable asset to production logistics in any sector

- Containers are the size of half a Euro pallet
- Load capacity 200 kg
- Convenient handling with hand pallet truck or forklift truck
- Large volume
- Large handles with rounded handrest
- Label holder on all four sides
- Colour: blue



**BITO-Plus**

800 x 600 mm



CONTAINERS WITH FORK ENTRY SHOES 800 X 600



### With ready-mounted runners and closed sides

External dimensions L x W	Height	Internal dimensions L x W x H	Volume	Load capacity	Stacking load	Bin type	Ref. no.
<i>mm</i>	<i>mm</i>	<i>mm</i>	<i>litres</i>	<i>kg</i>	<i>kg</i>		
800 x 600	220	762 x 562 x 101	36	200	800	XL86121DKUFE	43-22593
	320	762 x 562 x 201	79	200	800	XL86221DKUFE	43-22605
	420	762 x 562 x 301	121	200	800	XL86321DKUFE	43-20267
	520	762 x 562 x 401	164	200	800	XL86421DKUFE	43-22569
	620	762 x 562 x 501	206	200	800	XL86521DKUFE	43-22585



## European size stacking containers XL with double base with ready-mounted runners



### With solid sides, hinged two-part lid and runners

External dimensions L x W	Height	Internal dimensions L x W x H	Volume	Load capacity	Stacking load	Bin type	Ref. no.
<i>mm</i>	<i>mm</i>	<i>mm</i>	<i>litres</i>	<i>kg</i>	<i>kg</i>		
800 x 600	238	762 x 562 x 101	36	200	800	XLD86121DKUFE	43-22619
	338	762 x 562 x 201	79	200	800	XLD86221DKUFE	43-22617
	438	762 x 562 x 301	121	200	800	XLD86321DKUFE	43-20268
	538	762 x 562 x 401	164	200	800	XLD86421DKUFE	43-22618
	638	762 x 562 x 501	206	200	800	XLD86521DKUFE	43-22616



### With short side pick opening and fork entry shoes

External dimensions L x W	Height	Internal dimensions L x W x H	Pick opening W x H	Volume	Load capacity	Stacking load	Bin type	Ref. no.
<i>mm</i>	<i>mm</i>	<i>mm</i>	<i>mm</i>	<i>litres</i>	<i>kg</i>	<i>kg</i>		
800 x 600	420	762 x 562 x 301	459 x 153	121	200	800	XL86324DKufe	43-30249
	520	762 x 562 x 401	459 x 203	164	200	800	XL86424DKufe	43-30250
	620	762 x 562 x 501	459 x 253	206	200	800	XL86524DKufe	43-30251



### With long side pick opening and fork entry shoes

External dimensions L x W	Height	Internal dimensions L x W x H	Pick opening W x H	Volume	Load capacity	Stacking load	Bin type	Ref. no.
<i>mm</i>	<i>mm</i>	<i>mm</i>	<i>mm</i>	<i>litres</i>	<i>kg</i>	<i>kg</i>		
800 x 600	420	762 x 562 x 301	459 x 153	121	200	800	XL86326DKufe	43-30252
	520	762 x 562 x 401	459 x 203	164	200	800	XL86426DKufe	43-30253
	620	762 x 562 x 501	459 x 253	206	200	800	XL86526DKufe	43-30254

## Accessories



**A** Drop-on lid



**B** Security seals



**C** Security seals



**D** Covers for palletised loads

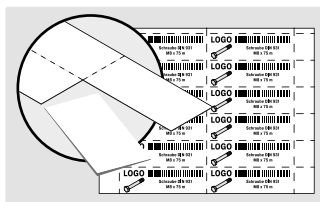

**E** Label sheets



**F** Label covers

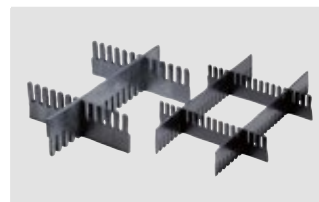

**G** Slot-in divider strips



**H** Insertable windows - permanently attached to bin



**I** Barcoded security seals



**J** Multi-trip transport solution for bins and containers

Pos.	Description	Dimensions	Product type	Pcs/pack	Ref. no.	
		<i>mm</i>				
<b>A</b>	Drop-on lid	L 800 x W 600	SLS86-46	1	52-30500	
<b>B</b>	Security seals	single use security seals, suited for all MB and XL containers sized 800 x 600 mm at the base, prevent tampering and opportunistic theft, 2 security seals required per container, colour: red, customised marking and colours on request	MBP2	500	6-15705	
<b>C</b>	Security seals	single use security seals with continuous numbering, suited for all MB, SL and XL containers sized 800 x 600 mm, colour: red	MBP2-L	500	6-19162	
<b>D</b>	Covers for palletised loads	cover palletised bins and containers	PAH12.80	1	9-18421	
<b>E</b>	Label sheets	pre-perforated blank label sheets, ready for direct printing, suited for laser and inkjet printers, on white DIN A4 sheets, 140 g/m <sup>2</sup> , 25 sheets per pack, colour white	46-20778	100	46-20778	
<b>F</b>	Label covers	angled upper edge allows easy label inserting from the top, suited for all XL and KLT containers	KLT-ET1	10	9-20053	
<b>G</b>	Slot-in divider strips	bin and container subdivision to your requirements, made from black recycled polypropylene, can be cut to required length with a wood or metal saw, upon request also available in ESD material, minimum order quantity: 500 pieces	L 950 x H 55 L 950 x H 120 L 1150 x H 50 L 1150 x H 80 L 1150 x H 180	SSU55/11 SSU120/11 SSU50/5 SSU80/5 SSU180/5	10 10 10 10 10	43-18419 43-18420 43-18417 43-18418 7-15509
<b>H</b>	Insertable windows - permanently attached to bin	provides protection against dust, made from polycarbonate to allow instant product viewing, easy product retrieval, mounted to bin to avoid loss, can also be opened when containers are stacked	W 460 x H 148 W 460 x H 198 W 460 x H 248	ES8632XL ES8642XL ES8652XL	10 10 10	43-20271 43-22548 43-30266
<b>I</b>	Barcoded security seals	single use security seals with consecutive 8-digit numbering (barcode/human-readable format), seals are supplied tied together in pairs with identical numbering, the BITO Smartphone app "Seal + Track" makes reading and transmitting seal numbers easy, custom prints upon request	MBP32L	250	6-31550	
<b>J</b>	Multi-trip transport solution for bins and containers	can be moved without hand pallet truck or forklift truck standard dimensions of 800 x 600 mm (1/2 Euro pallet), More information on page 126				



### Heavy duty containers SL

#### The new generation ...

Stock loads as high as 500 kg in a BITOBOX sized 800 x 600 mm!



This heavy duty container series from BITO sets new standards in production, storage and transport logistics.

With an empty weight of 14.5 kg or 18 kg depending on the container height, the BITO SL weighs much less than a traditional wire-mesh box pallet or a steel sheet container, but provides a comparable load capacity.

BITO heavy duty containers are not only great for heavy weight loads. They are also ideal for large size products and goods which must be stored and shipped under absolutely clean and dustfree conditions.

**BITOBOX SL**



CONTAINERS WITH FORK ENTRY SHOES 800 X 600





CONTAINERS WITH FORK ENTRY SHOES 800 X 600

## Product features



### Drop door

Optionally available on short or long side. Jam-free operation due to synchronised hinges. Only one hand needed to close door, also when containers are stacked.

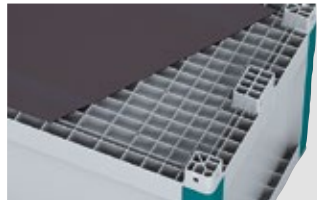

### Double base

Welded sandwich construction for high load capacities. Version for automated bin storage (flat base, no runners) can be supplied upon request.



### Runners

Suited for fork lift truck or hand pallet truck handling. Easy to mount and to remove. Convenient in-house transfer with a hand pallet truck or a container dolly. Can also be handled on powered and gravity-driven conveyors.



### Dual colour design

Colour coding for easy stock identification: corner uprights can be supplied in various colours – ask for minimum order quantity.



### Plenty of space for your company logo

Choose from various marking methods: injection moulding – pad print – screen print.



### Lid options:

Hinged lid: firm fit, can be strap-sealed and security-sealed.  
Drop-on lid: perfect protection against soiling, easy drop-on fitting and removal (supplied upon request).

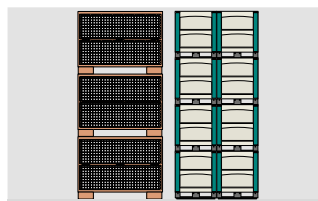

### Optimum container size

The trend towards reduced batch sizes demands smaller bulk storage containers. Advantage: more items can be stored on the same floor space.



### Stacks up to 1500 kg

Safe stacking – even when fully loaded, static stacking load: 1500 kg, dynamic stacking load: 1000 kg



### Light weight champion

Weighs much less than a same size metal container, but with similar load capacity



### Clean and safe

Smooth internal sides allow easy cleaning, completely closed construction is ideal for storing and transporting liquids in jerrycans and drums.



### Optional transport trolley

ideal for in-house handling.



### Heavy duty containers SL

Designed for premium performance – 500 kg load capacity

- Containers are the size of half a Euro pallet
- Load capacity 500 kg
- Static stacking load 1500 kg
- Dynamic stacking load 1000 kg
- Products are kept clean and safe - in line with modern production principles
- Colour: grey



**BITO-Plus**

BITO Quality  
5 years

05  
PP

supplied  
in any colour  
for orders  
exceeding 500 pcs.

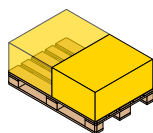

800 x 600 mm

#### With solid sides

External dimensions L x W	Height	Internal dimensions L x W x H	Volume	Load capacity	Stacking load	Bin type	Ref. no.
mm	mm	mm	litres	kg	kg		
800 x 600	520	739 x 539 x 373	145	500	1500	SL86421K	52-30342
	720	739 x 539 x 573	223	500	1500	SL86621K	52-30343

#### With hinged two-part lid

External dimensions L x W	Height	Internal dimensions L x W x H	Volume	Load capacity	Stacking load	Bin type	Ref. no.
mm	mm	mm	litres	kg	kg		
800 x 600	541	739 x 539 x 373	145	500	1500	SLD86421K	52-30368
	741	739 x 539 x 573	223	500	1500	SLD86621K	52-30369



CONTAINERS WITH FORK ENTRY SHOES 800 X 600



## With long side pick opening

External dimensions L x W	Height	Internal dimensions L x W x H	Volume	Load capacity	Stacking load	Bin type	Ref. no.
<i>mm</i>	<i>mm</i>	<i>mm</i>	<i>litres</i>	<i>kg</i>	<i>kg</i>		
800 x 600	520	739 x 539 x 373	145	500	1500	SL86426K	52-30364
	720	739 x 539 x 573	223	500	1500	SL86626K	52-30365



## With short side pick opening

External dimensions L x W	Height	Internal dimensions L x W x H	Volume	Load capacity	Stacking load	Bin type	Ref. no.
<i>mm</i>	<i>mm</i>	<i>mm</i>	<i>litres</i>	<i>kg</i>	<i>kg</i>		
800 x 600	520	739 x 539 x 373	145	500	1500	SL86424K	52-30354
	720	739 x 539 x 573	223	500	1500	SL86624K	52-30355



## With half-drop door on the long side

- Anti-jam half-drop door

External dimensions L x W	Height	Internal dimensions L x W x H	Volume	Load capacity	Stacking load	Bin type	Ref. no.
<i>mm</i>	<i>mm</i>	<i>mm</i>	<i>litres</i>	<i>kg</i>	<i>kg</i>		
800 x 600	520	739 x 539 x 373	145	500	1500	SLK86426K	52-30366
	720	739 x 539 x 573	223	500	1500	SLK86626K	52-30367

## Heavy duty containers SL



### With half-drop door on the short side

- Anti-jam half-drop door

External dimensions L x W	Height	Internal dimensions L x W x H	Volume	Load capacity	Stacking load	Bin type	Ref. no.
<i>mm</i>	<i>mm</i>	<i>mm</i>	<i>litres</i>	<i>kg</i>	<i>kg</i>		
800 x 600	520	739 x 539 x 373	145	500	1500	SLK86424K	52-30356
	720	739 x 539 x 573	223	500	1500	SLK86624K	52-30357



### With half-drop door on the short side and with hinged two-part lid

- Anti-jam half-drop door

External dimensions L x W	Height	Internal dimensions L x W x H	Volume	Load capacity	Stacking load	Bin type	Ref. no.
<i>mm</i>	<i>mm</i>	<i>mm</i>	<i>litres</i>	<i>kg</i>	<i>kg</i>		
800 x 600	541	739 x 539 x 373	145	500	1500	SLDK86424K	52-30370
	741	739 x 539 x 573	223	500	1500	SLDK86624K	52-30371



### Without fork entry shoes to suit automated storage

- This variant is not stackable

External dimensions L x W	Height	Internal dimensions L x W x H	Volume	Load capacity	Stacking load	Bin type	Ref. no.
<i>mm</i>	<i>mm</i>	<i>mm</i>	<i>litres</i>	<i>kg</i>	<i>kg</i>		
800 x 600	420	739 x 539 x 373	145	500	1500	SL86421AKL	52-30346
	620	739 x 539 x 573	223	500	1500	SL86621AKL	52-30347

## Accessories



**A** Drop-on lid



**B** Label holders



**C** Document pockets



**D** Slot-in divider strips



**E** Intermediate drop-in-layers

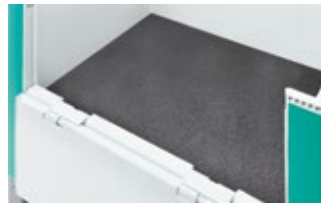

**F** Non-slip grip matting



**G** Hand pallet trucks



**H** Transport dollies



**I** Multi-trip transport solution for bins and containers

Pos.	Description		Dimensions <i>mm</i>	Product type	Pcs/pack	Ref. no.
<b>A</b>	Drop-on lid	will cover container stacks, can also be used to close individual containers	L 800 x W 600	SLS86-46	1	52-30500
<b>B</b>	Label holders	welded to container by manufacturer, protection for shipping documents and stock identification cards	W 240 x H 80 W 240 x H 168	SL-ET1 SL-ET2	1 1	52-30386 52-30387
<b>C</b>	Document pockets, self-adhesive 3 sides open	ideal for frequent exchange of inserts, adhesive fabric backing provides strong adhesion, colour transparent	L 175 x W 105 L 210 x W 150	MBET MBETDINA5	10 10	6-5031 6-19528
<b>D</b>	Slot-in divider strips, lengthwise	bin and container subdivision to your requirements, made from black recycled polypropylene, can be cut to required length with a wood or metal saw, upon request also available in ESD material, minimum order quantity: 500 pieces	L 724 x W 10 x H 120	52-30383	10	52-30383
	Slot-in divider strips, crosswise		L 724 x W 5 x H 180	52-30385	10	52-30385
			L 524 x W 10 x H 120	52-30382	10	52-30382
			L 524 x W 5 x H 180	52-30384	10	52-30384
<b>E</b>	Intermediate drop-in-layers, for heavy duty containers SL	allow to store products in several layers in the same container	L 724 x W 524	52-30381	1	52-30381
<b>F</b>	Non-slip grip matting, for heavy duty containers SL	will protect container base from damage by rough infeeding of items	L 720 x W 520 x H 8	52-30380	10	52-30380
<b>G</b>	Hand pallet trucks	fork length 600 mm, width over forks 520 mm, load capacity 2000 kg, swivel castors and load rollers from polyurethane	L 600 x W 150	52-30379	1	52-30379
<b>H</b>	Transport dollies, for containers sized 800 x 600 mm	supplied with 2 swivel and 2 fixed castors, suited for containers sized 800 x 600 mm, made from polypropylene	L 800 x W 600 x H 198	RU86.125	1	43-1150
<b>I</b>	Multi-trip transport solution for bins and containers	can be moved without hand pallet truck or forklift truck, standard dimensions of 800 x 600 mm (1/2 Euro pallet), More information on page 126	-			



CONTAINERS WITH FORK ENTRY SHOES 800 X 600



### Pallet top cap and pallet dolly

This multi-trip solution for bins and containers handles your packaging and transport needs: **easy to use, immediately operational, no packaging waste, safe, no service vehicles needed**

Combine a pallet top cap + bins & containers + pallet dolly for moving loads safely around your premises. It also makes an ideal shipping unit to external destinations.

Benefit from the added economic and ecologic value:

- **Loads are held in place by the pallet top cap and 2 integrated tension straps**
- **This compact solution saves on transport costs thanks to a smaller freight volume than f.ex. roll containers**
- **Substantial time and cost savings since there is no need for repeated re-packaging**
- **No packaging materials required (i.e. foil wrapping or plastic strapping)**
- **Loads can be moved without a hand pallet truck or a forklift truck**
- **When the unit is unloaded, pallet top caps and and pallet dollies can be stacked to save on space on return transports**

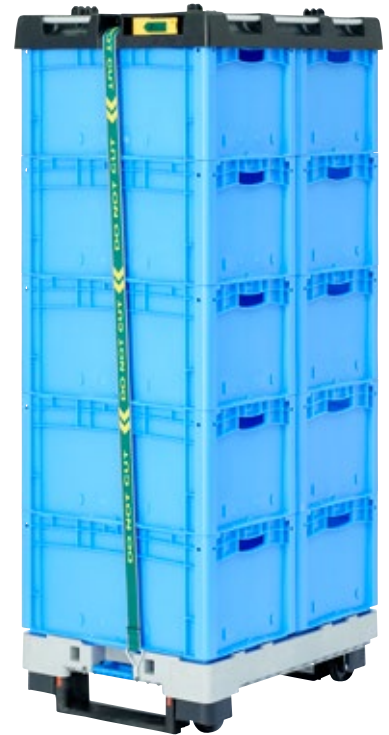

#### Convenient and fast handling by one person only



1 Place pallet top cap on bins



2 Fix tension straps



3 Tighten straps



4 Unlock dolly and get going

#### The ergonomic handle and the towing hitch allow you to move the pallet dolly without effort



A Handle



B Towing coupler

MULTI-TRIP TRANSPORT SOLUTION

## Pallet top cap, with integrated tension straps

- Made of durable polypropylene with 2 integrated, self-retracting ratchet straps (length 2 m)
- Secures loads quickly and without wasting packaging materials
- Suited for a wide range of bins and containers such as multi-purpose containers MB, European size stacking containers XL, small parts containers KLT and heavy-duty containers SL
- Supplied with hook for dollies / transport trolleys
- Standard dimensions of 800 x 600 mm (1/2 Euro pallet)

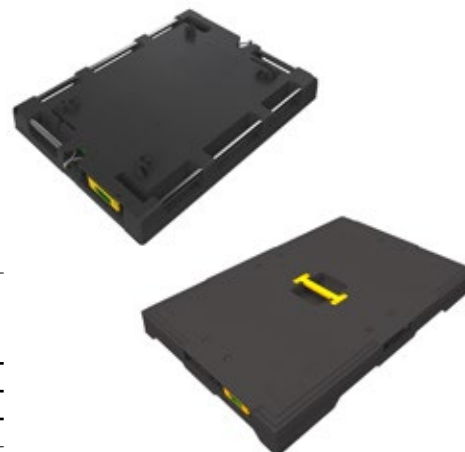

Length	Width	Height	Max. loading height	Temperature range	Features	Ref. no.
<i>mm</i>	<i>mm</i>	<i>mm</i>	<i>mm</i>			
822	618	93	1980	-20°C to +40°C	Ratchet strap for pallet dollies	22-54830
1222	822	118	1980	-20°C to +40°C	Ratchet strap for timber pallets	22-51114
	822	118	1980	-20°C to +40°C	Ratchet strap for plastic pallets	22-51115

## Pallet dolly, top deck with load retaining lips

- Combines features and benefits of a pallet and a dolly
- The “pallet” converts into a dolly by actuating the foot pedal
- Can be moved without hand pallet truck or forklift truck
- Can be stacked for saving space on empty return trips
- Standard dimensions of 800 x 600 mm (1/2 Euro pallet)
- Made from polypropylene

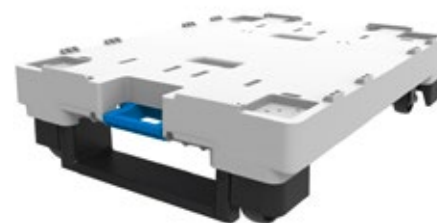

Length	Width	Height	Floor clearance	Load capacity	Castors	Temperature range	Ref. no.
<i>mm</i>	<i>mm</i>	<i>mm</i>	<i>mm</i>	<i>kg</i>			
800	600	196	36	250	nylon	-20°C to +40°C	22-54831

## Accessories



**A** Handle



**B** Towing coupler

Pos.	Description		Load capacity	Length	Width	Height	Product type	Pcs/pack	Ref. no.
			<i>kg</i>	<i>mm</i>	<i>mm</i>	<i>mm</i>			
<b>A</b>	Handle	ergonomic easy-to-grip handle, hook-on fitting	-	1000	320	150	22-54835	1	22-54835
<b>B</b>	Towing coupler	allows to tow 2 pallet dollies at a time	250	310	315	105	22-54836	1	22-54836
			500	310	315	105	22-54837	1	22-54837

Pallet dolly + bins + pallet top cap = compact material handling unit for use with the following bin & container series:

### European size stacking containers XL

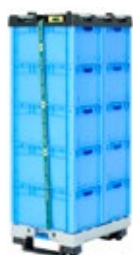

from page 54

### Small parts Containers KLT



from page 72

### Multi-purpose containers MB



from page 83

### Heavy duty Containers SL



from page 122



## Pallet boxes

Heavy duty container in European pallet size and industry pallet size

- **Load capacity 500 kg**
- **Large volume**
- **Made from PE-HD = long service life, 100% recyclable**
- **Double-walled, closed sides**
- **Extremely strong**
- **Easy-to-clean inside shape and surfaces**
- **Reinforcing corner profiles enable safe stacking**
- **Drainage holes in the sides and the base**
- **Optionally available with long side pick opening**
- **Optionally with 4 feet, 4 castors or 3 runners**
- **Solid, injection-moulded lid (see accessories)**

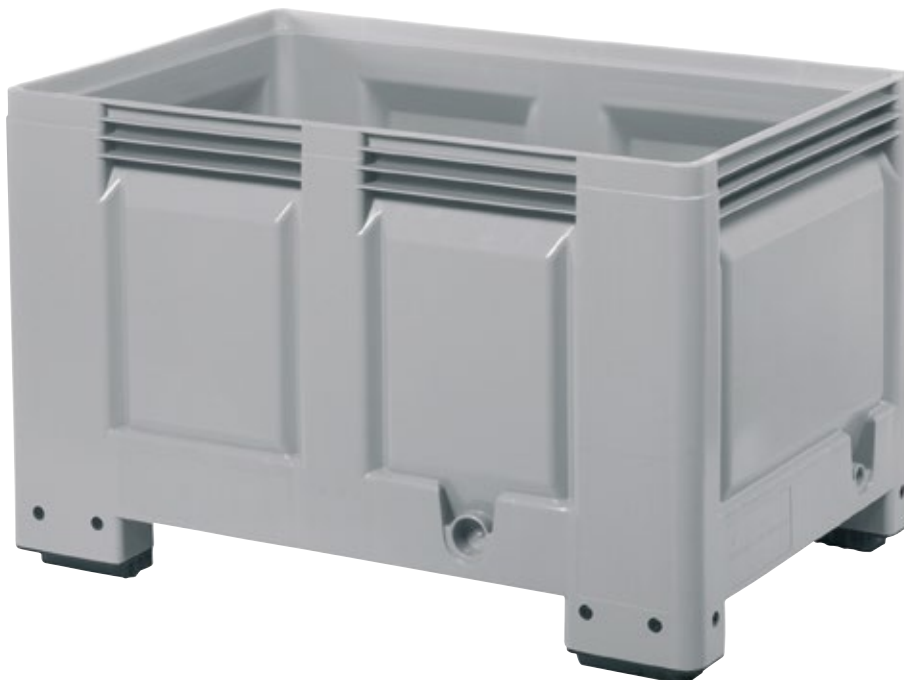

LARGE VOLUME CONTAINERS

**BITO-Plus**



Description	External dimensions	Height	Internal dimensions	Volume	Load capacity	Stacking load	Bin type	Ref. no.
	L x W		L x W x H		kg			
	<i>mm</i>	<i>mm</i>	<i>mm</i>	<i>litres</i>	<i>kg</i>	<i>kg</i>		
with 4 feet without drop door	1200 x 800	760	1100 x 710 x 610	535	500	4500	PC1871	7-11269
	1200 x 1000	760	1100 x 910 x 610	670	500	4500	PC1171	7-11276
with 4 castors without drop door	1200 x 800	915	1100 x 710 x 610	535	500	500	PCR1871	7-12933
	1200 x 1000	915	1100 x 910 x 610	670	500	500	PCR1171	7-12935
with 3 runners without drop door	1200 x 800	790	1100 x 710 x 610	535	500	4500	PC1873	7-15513
	1200 x 1000	790	1110 x 910 x 610	670	500	4500	PC1173	7-11280
with 4 feet long side pick opening 735 x 310 mm	1200 x 800	760	1100 x 710 x 610	535	500	4500	PC1874	7-11270
	1200 x 1000	760	1100 x 910 x 610	670	500	4500	PC1174	7-11277

### Accessories



**A** Drop-on lid

Pos.	Description		To suit containers	Product type	Ref. no.
			sized L x W		
			<i>mm</i>		
<b>A</b>	Drop-on lid	reliable protection against soiling, individual lids can be nested to save on space	1200 x 800	PD800	7-11282
			1200 x 1000	PD1000	7-11283

**Pallet containers CB1 / CB3**  
with 3 runners

- Pallet boxes are particularly stable since they are made of one piece
- Additional ribbing above the entry opening provides impact protection and increase resistance to forklift forks
- The seamless design and smooth interior walls of this bulk carrier enable easy emptying, cleaning, and drying
- Pallet boxes are temperature resistant from -30 to +40°C, briefly up to +90°C, as well as to most chemicals and cleaning agents
- Integrated stacking lugs on the outside corners provide secure support for stacked pallet containers



LARGE VOLUME CONTAINERS

**BITO-Plus**



**With 3 runners**

External dimensions L x W	Height	Volume	Load capacity	Stacking load	Load capacity	Colour	Ref. no.
<i>mm</i>	<i>mm</i>	<i>litres</i>	<i>kg</i>	<i>kg</i>	<i>kg</i>		
1200 x 800	740	470	700	5000	1200	red	7-51260
		470	700	5000	1200	light grey	7-51261
		470	700	5000	1200	light blue	7-51259
		470	700	5000	1200	green	7-51258
		470	700	5000	1200	yellow	7-51257
		470	700	5000	1200	blue	7-51256
		470	700	5000	1200	basalt gray	7-51255
1200 x 1000	740	610	700	5000	1200	red	7-51253
		610	700	5000	1200	light grey	7-51254
		610	700	5000	1200	light blue	7-51252
		610	700	5000	1200	green	7-51251
		610	700	5000	1200	yellow	7-51250
		610	700	5000	1200	blue	7-51249
		610	700	5000	1200	basalt gray	7-51248



### Foldable pallet boxes MAGNUM Optimum

with 3 feet, half-drop front on the long and on the short side

- **MAGNUM Optimum boxes are foldable plastic pallet boxes with two hinged half-drop doors, one on the long side, one on the short side and a closed base with 4 drainage holes**
- **The sides have a smooth surface and are closed**
- **When folded, the MAGNUM Optimum boxes are only 295 mm high, thus achieving a volume reduction of approx. 70%**
- **Double-walled sides with integrated reinforcing ribs**
- **The smooth sandwich walls provide for excellent stability and are easy to clean**
- **Optional: additional drop-on lid on request**



External dimensions L x W	Height	Internal dimensions L x W x H	Folded height	Volume	Bin type	Ref. no.
<i>mm</i>	<i>mm</i>	<i>mm</i>	<i>mm</i>	<i>litres</i>		
1200 x 800	958	1142 x 742 x 785	295	665	PK120896M-46	7-51246
1200 x 1000	975	1140 x 940 x 790	295	847	PK121098M-46	7-51244

### Large volume containers

foldable, with 3 runners

- **SMARTBOX large volume containers are built with 3 skids that provide greater resistance and stability and allow moving them with pallet trucks or forklifts**
- **Half-drop front on the long and on the short side**
- **Optimized logistics and warehousing**
- **Safe stacking: the skids enable precise stacking both when the container is open and when it is folded**
- **No sharp edges which could damage the load**
- **The boxes are 100% recyclable**



Description	External dimensions L x W	Height	Internal dimensions L x W x H	Folded height	Volume	Load capacity	Stacking load	Bin type	Ref. no.
	<i>mm</i>	<i>mm</i>	<i>mm</i>	<i>mm</i>	<i>litres</i>	<i>kg</i>	<i>kg</i>		
	1200 x 800	805	1120 x 720 x 660	298	565	650	7000	PK128080S-46	7-51241
	1200 x 800	978	1120 x 720 x 833	470	695	750	7000	PK128098S-46	7-51243
closed shelves	1200 x 800	805	1120 x 720 x 660	298	565	650	7000	PK128081S	7-51240
	1200 x 800	978	1120 x 720 x 833	470	695	750	7000	PK128091S	7-51242

## Folding bulk containers



Protect your goods from dust and dirt during storage and transport!

- **3-part system = pallet + sides + lid**
- **Picking flap on the long side**
- **Very strong foldable side construction from impact-resistant plastic**
- **Supplied with 9 feet each**
- **Considerable reduction in volume when empty (folded height about 250 mm, volume savings of up to 77%)**
- **Low proper weight**
- **Easy to handle**
- **100% recyclable**
- **Custom prints available**
- **Containers with fork entry shoes upon request**



Folds away when not in use



LARGE VOLUME CONTAINERS

Description	External dimensions L x W <i>mm</i>	Height <i>mm</i>	Internal dimensions L x W x H <i>mm</i>	Volume <i>litres</i>	Stacking load <i>kg</i>	Load capacity <i>kg</i>	Bin type	Ref. no.
with feet	1200 x 800	885	1155 x 755 x 725	606	1000	1200	BMD1280S	7-20050
					500	1200	BMD1280	7-20047
	1245 x 845	855	1200 x 800 x 695	667	1000	1200	BMD1280IS	7-20051
					500	1200	BMD1280I	7-20048
with ready-mounted runners	1200 x 1000	1090	1160 x 960 x 925	1030	1000	1200	BMD1210S	7-20052
					500	1200	BMD1210	7-20049



### Plastic pallets

The modern alternative to wooden pallets

- All pallets from recycling material
- Available as stackable or nestable version

PALLETS



**A** Display pallets K9, nestable



**B** Display pallets K9



**C** Light duty pallets K8 with feet, nestable



**D** Heavy duty pallets K2 with feet, nestable



**E** Pallets K6 with runners, stackable



**F** Pallets K1 with runners, stackable

Pos.	External dimensions L x W mm	Height mm	Static load capacity kg	Dynamic load capacity kg	Rack load capacity kg	Description	Colour	Ref. no.	Pack quantity
<b>A</b>	600 x 400	150	500	200		without retaining lip	black	7-30291	30 pcs
<b>B</b>	800 x 600	115	1000	500		without retaining lip	black	7-20038	30 pcs
<b>C</b>	1200 x 800	155	2500	1000		deck with load retaining lip	grey	7-20039	40 pcs
	1200 x 1000	155	2500	1000		deck with load retaining lip	grey	7-20040	40 pcs
<b>D</b>	1200 x 800	145	4000	1200		without retaining lip	black	7-20041	40 pcs
	1200 x 1000	145	4000	1200		without retaining lip	black	7-20042	40 pcs
<b>E</b>	1200 x 800	150	6000	2500	500	without retaining lip	grey	7-20043	20 pcs
	1200 x 1000	150	5000	1500	400	without retaining lip	grey	7-20044	20 pcs
<b>F</b>	1200 x 800	155	7500	2500	1250	deck with load retaining lip	grey	7-20045	20 pcs
	1200 x 1000	155	7500	2500	1250	deck with load retaining lip	grey	7-20046	20 pcs

## Plastic pallets

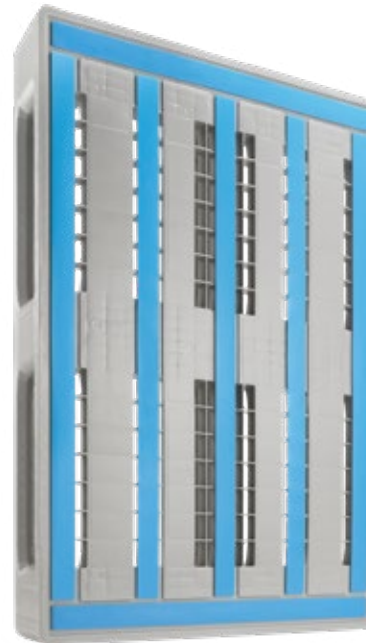

PALLETS

**With 3 feet, without external locking mechanism**

- Identical in design to the Eurowood pallet
- Palgrip® anti-slip coating on the upper deck
- Palgrip® anti-slip skids
- Perfect for automation



External dimensions L x W x H	Static load capacity	Dynamic load capacity	Rack load capacity	Colour	Bin type	Pack qty	Ref. no.
<i>mm</i>	<i>kg</i>	<i>kg</i>	<i>kg</i>				
1200 x 800 x 150	7500	1250	1250	grey	L1-1280	15	7-51280

**With 3 feet, with external locking mechanism 7 mm**

- Supplied as standard with 4 corner elements, prevents shifting of the packaging film
- Sturdy construction
- Bevels on both sides of all skids allow optimal use with industrial trucks
- Empty weight of only 12 kg



External dimensions L x W x H	Static load capacity	Dynamic load capacity	Rack load capacity	Colour	Bin type	Pack qty	Ref. no.
<i>mm</i>	<i>kg</i>	<i>kg</i>	<i>kg</i>				
1200 x 800 x 150	5000	1000	400	black	D1-1280	15	7-51279

**With 3 feet, with external locking mechanism 5 mm**

- Palgrip® anti-slip coating on the upper deck
- Palgrip® anti-slip skids
- Corrosion-protected stiffening profiles for a load capacity of up to 2,000 kg in high-bay racking



External dimensions L x W x H	Static load capacity	Dynamic load capacity	Rack load capacity	Colour	Bin type	Pack qty	Ref. no.
<i>mm</i>	<i>kg</i>	<i>kg</i>	<i>kg</i>				
1200 x 1000 x 160	7500	2000	2000	light grey/light blue	L3-1210	15	7-51281





## BITO plastic bins and containers – designed for use in storage, distribution and assembly environments

Less packaging waste, lower storage and freight costs, easy handling, a robust make, a broad range of models and variations, ergonomic design and a 5 year assurance on quality and function are just some of the benefits provided by a BITOBOX.

BITO provides an impressive range of bins and containers for any application - from bins and containers for storage and order picking over various stacking container series in European standard sizes, multi-purpose containers, bins and trays for automated small parts facilities to pallet containers.



Further information on this product is provided in our catalogue **PROJECT GUIDE** which is available free of charge. To obtain your copy please send us an email to [info@bito.com](mailto:info@bito.com)



## Plastic bins and containers



## ...in the order picking process



## Designed for use on conveyors...



## Plastic bins and containers



## ...in assembly areas



## ...in distribution chains



## Plastic bins and containers



## ...in shelving and racking



BINS & CONTAINERS





BITO shelving and racking systems are manufactured in our plant at Meisenheim – for load capacities between 50 to 4500 kg per storage level, for small, large, light weight, heavy weight, bulky and long goods, for use as stand-alone bays as well as in multi-tier facilities.

BITO shelving and racking is made with the latest state-of-the-art technology. The high degree of automation such as in the steel bending process makes sure that all products are absolutely true to size and of a consistent quality. Moreover, professional production planning and tool engineering, optimised manufacturing processes and a competent order management guarantee efficient lead times.

BITO will be pleased to assist you in choosing the optimum solution!

**Please note:** This racking system has been designed for in-door use only. The indicated load capacities are not valid for earthquake hazard zones. If your storage and order picking facility is intended for use in a seismic hazard zone, please inform BITO in advance!



...BITO provides a solution to suit you!



SHELVING & RACKING



**Contents**

**Shelving ..... 140**

**Archive shelving ..... 142**

**Boltless shelving for industry requirements..... 144**

Light duty shelving type EL - shelf load 100 kg ..... 144

Light duty shelving type L - shelf load 100 kg ..... 145

Medium duty shelving type M - shelf load 200 kg.... 146

Heavy duty shelving type S - shelf load 300 kg ..... 147

**Shelving with extra large shelves ..... 148**

Shelving with extra large chipboard shelves ..... 148

Shelving with extra large steel shelves ..... 149

**Boltless shelving for industry requirements..... 150**

Supply shelving ..... 151

Shelving with inclined shelves..... 154

Kanban bin shelving for small parts ..... 155

Boltless shelving complete with RK bins..... 156

Mobile shelving trolleys with RK bins ..... 157

Boltless shelving complete with SK bins..... 158

Boltless shelving complete with XL bins ..... 160

Boltless shelving complete with XL and RK bins ..... 160

Mobile shelving trolleys ..... 161

Mobile shelving trolleys with roller tracks..... 161

Hose shelving ..... 162

Hose shelving - shelf trolley ..... 162

Cabinets for fire fighting equipment ..... 163

Boltless shelving with wire baskets - wire baskets... 164

Shelving with wire shelves - wire shelves ..... 165

Corner shelving ..... 166

Tyre shelving ..... 167

Tyre shelving - shelf trolley..... 167

**Accessories for boltless shelving..... 168**

Frames..... 169

Louvered panels ..... 172

Back cladding ..... 173

Shelves..... 174

Shelf ledges .....	174	Carton live storage Flex - Set offer .....	222
Wire shelves GRID .....	175	Complete levels.....	224
Beams .....	176	<b>Cantilever racking..... 226</b>	
Shelf dividers .....	177	<b>Cantilever racking for light duty applications ... 226</b>	
Bin shelves for loose goods.....	178	Cantilever racking type L.....	227
Vertical storage .....	178	Cantilever racking type S .....	230
Wire-mesh partitions.....	179	Cantilever racking components type L and S.....	232
Hinged doors .....	181	<b>Racks for vertical storage .....</b>	<b>234</b>
Retrofit drawers.....	182	<b>Cantilever racking for heavy duty applications ... 236</b>	
<b>Stainless steel shelving .....</b>	<b>184</b>	Cantilever racking type ES .....	238
<b>Wide span racking .....</b>	<b>186</b>	Cantilever racking components type ES .....	240
Wide span racking .....	186	<b>Sheet/plate racks .....</b>	<b>242</b>
Frames.....	190	Racks for sheets and boards .....	242
Complete levels.....	191	<b>Wire-mesh partitions .....</b>	<b>243</b>
Wide span shelving – coordinating products.....	193		
<b>Pallet racking .....</b>	<b>194</b>		
PRO Pallet racking .....	194		
Pallet racking - complete units.....	196		
Pallet racking- Frames.....	199		
Beams .....	201		
Level decking options to fit BITO-TwinTop® beams .	202		
Pull-out units .....	204		
Rack end protector set .....	205		
Shelving & racking protection .....	206		
Flexible upright protectors .....	207		
Safety equipment .....	208		
<b>Order picking of palletised loads ....</b>	<b>210</b>		
Pallet live storage .....	210		
Heavy duty roller tracks .....	214		
<b>Picking of unit loads .....</b>	<b>215</b>		
Carton live storage.....	216		
Roller tracks .....	218		
Carton live storage Flex .....	220		



## Boltless shelving

### Neat product presentation in office and workshop environments





BITO Shelving provides utmost versatility as it adapts to any location. Assembly is fast and easy without nuts and bolts and can be done by anyone as no special skills are required. The modular system allows the addition of extra shelves and bays as needed.

BITO shelving comes with a very broad range of accessories to suit any environment and industry. The robust make also allows for multi-tier installations. Please contact our sales team to discuss your requirements.

**Please note:** This racking system has been designed for in-door use only. The indicated load capacities are not valid for earthquake hazard zones. If your storage and order picking facility is intended for use in a seismic hazard zone, please inform BITO in advance!



SHELVING

Load cap. per level					
					
Shelf width	750 mm	1.000 mm	1.300 mm	1.500 mm	2.000 mm
Useable depth	Load capacities (UDL)				
300 mm	200 kg	100, 200 kg	100, 200 kg	-	-
400 mm	200 kg	100, 200, 300 kg	100, 200 kg	-	-
500 mm	200 kg	100, 200, 300 kg	100, 200 kg	350 kg	350 kg
600 mm	200 kg	100, 200, 300 kg	100, 200 kg	350 kg	350 kg
800 mm	200 kg	200 kg	200 kg	350 kg	350 kg

Max. shelf/bay loads				
Shelving type	EL (starting on page 136)	L (starting on page 137)	M / S (starting on page 138)	Shelving with extra large shelves (starting on page 139)
Max. shelf load	100 kg	100 kg	200 / 300 kg	350 kg
Max. bay load	800 kg	1.300 kg	1.600 kg	1.600 kg

## Shelving

Quick and easy to assemble in just a few steps



Scan this QR code:  
**Instructions on assembly  
 and use for boltless  
 shelving**  
[www.bitto.com/en-gb/downloads](http://www.bitto.com/en-gb/downloads)



SHELVING



## Uprights

- **High load capacities** are achieved through precision steel bending to ensure sufficient rigidity for realising shelving heights of up to 10 metres.
- Slim 50 mm profiles contribute to maximum space utilisation.



## Frames

- **Easy boltless assembly** on site for perfect adaptation to your location.
- Level spacing can be adjusted in 25 mm increments to suit your needs.



## Beams

- **Beams and uprights form a solid force-fit connection** that provides excellent lateral stability. The three location hooks of each beam connector conveniently slot into the upright perforations.
- Safety pins prevent that the beam is accidentally dislodged.



## Shelves

- **Solid shelves with shelf clips** - Our shelves feature box-profiled edges at the long sides and triple edge bending at the short sides.
- Reinforcing lengthwise beads and pressure joined corners ensure excellent stability.
- All shelves are perforated to accommodate shelf dividers.



## BITO info

## Epoxy-coating

At a small extra charge, frame uprights can be supplied with a high-quality epoxy coated finish in RAL 3000 Flame red, RAL 5010 Gentian blue and RAL 7035 Light grey!

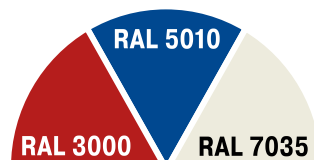

## Guide to planning your shelving installation:

## Nominal dimensions:

## Shelf widths:

750, 1000 and 1300 mm

## External bay depths:

324, 424, 524, 624 and 824 mm

## Shelf depths:

300, 400, 500, 600 and 800 mm

## Space utilisation:

## Width of starter bay:

Nominal shelf width + 58 mm

## Width of extension bay:

Nominal shelf width + 8 mm

## Shelving depth of starter and extension bay:

Nominal size + 24 mm



## Archive shelving

single sided use, galvanised finish

Everything in its right place !

- Shelf load: 70 kg
- Bay load: 500 kg
- Fast and easy assembly without bolts saves time
- Extensions possible at any time
- Shelf levels adjustable in 25 mm increments
- All loads indicated refer to uniformly distributed loads



**TOP SELLER** !

10-52945

**Set offer including 1 starter bay and 1 extension bay**

supplied with 12 shelves for 144 lever arch files  
H x W x D: 2200 x 2066 x 324 mm  
Ref. no. 10-52945



Width of starter bay  
1058 mm  
808 mm

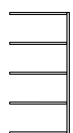

Width of extension bay  
1008 mm  
758 mm

Shelving height <i>mm</i>	Number of shelves	External bay depth <i>mm</i>	Useable depth <i>mm</i>	Shelf width <i>mm</i>	Shelving type	Starter bay	Extension bay
					File capacity	Ref. no.	Ref. no.
1850	5	324	300	1000 mm	60	10-12640	10-12641
2200	6				72	10-12644	10-12645
2500	7				84	10-12648	10-12649
3000	8				96	10-12652	10-12653

### Accessories



**A** Shelf, 25 mm high



**B** Shelf dividers



**C** Shelf ledges



**D** Side protection



Safety accessories such as anchor bolts and wall mounting sets on page 171

Pos.	Description	For a shelf length of <i>mm</i>	For a shelving depth of <i>mm</i>	Ref. no.
<b>A</b>	Shelf, 25 mm high set includes 4 shelf clips, shelf height 25 mm, with shelf perforations for dividers, ultra flat shelves help you make the most of your storage space, all loads indicated refer to uniformly distributed loads	1000	300	10-C1165-0006
<b>B</b>	Shelf dividers slot-in fitting, for 25 mm high shelves, freestanding divider, subdivide storage levels into several compartments, immediate stock identification even if several references are stocked on the same level, convenient slot-in fitting into shelf perforations, galvanised	-	300	10-52213
		-	300	10-52214
		-	300	10-52215
<b>C</b>	Shelf ledges for 25 mm high shelves, to be inserted between shelf and shelf clips, prevent goods from slipping off the shelf, galvanised	1000	-	10-52182
<b>D</b>	Side protection prevents objects from falling at the shelving sides, particularly suited for office and archive shelving, boltless assembly, easy fixing to frame with 2 plastic rivets included in the delivery, can be retro-fitted, galvanised finish	-	300	10-12833

## Archive shelving

double sided use, galvanised finish

Everything in its right place !

- Shelf load: 100 kg
- Bay load: 800 kg
- Fast and easy assembly without bolts saves time
- Extensions possible at any time
- Shelf levels adjustable in 25 mm increments
- Shelves are perforated to accept centre rail for files
- All loads indicated refer to uniformly distributed loads



SHELVING

**TOP SELLER**

10-52946

**Set offer including 1 starter bay and 1 extension bay**

supplied with 12 shelves for 288 lever arch files  
H x W x D: 2200 x 2066 x 624 mm  
Ref. no. 10-52946



Width of starter bay  
1058 mm  
808 mm

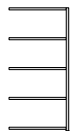

Width of extension bay  
1008 mm  
758 mm

Shelving height <i>mm</i>	Number of shelves	External bay depth <i>mm</i>	Useable depth <i>mm</i>	Shelf width 750 mm		Shelf width 1000 mm	
				Shelving type Starter bay Ref. no.	Extension bay Ref. no.	Shelving type Starter bay Ref. no.	Extension bay Ref. no.
1850	5	624	600	10-26860	10-26864	10-17149	10-17150
2200	6			10-26861	10-26865	10-17151	10-17152
2500	7			10-26862	10-26866	10-17153	10-17154
3000	8			10-26863	10-26867	10-17155	10-17156

### Accessories



**A** Shelf, 40 mm high



**B** Centre rails



**C** Side protection



Safety accessories such as anchor bolts and wall mounting sets on page 171

Pos.	Description		For a shelf length of <i>mm</i>	For a shelving depth of <i>mm</i>	Ref. no.
<b>A</b>	Shelf, 40 mm high	set includes 4 shelf clips, shelf height 40 mm, with shelf perforations for dividers	1000	600	10-17066
<b>B</b>	Centre rails	for double sided use, convenient slot-in fitting into shelf perforations, suited for office and archive shelving, galvanised	1000	600	10-6638
<b>C</b>	Side protection	prevents objects from falling at the shelving sides, particularly suited for office and archive shelving, boltless assembly, easy fixing to frame with 2 plastic rivets included in the delivery, can be retro-fitted, galvanised finish	-	600	10-12836

### Light duty shelving type EL - shelf load 100 kg galvanised finish

Ideal for light weight loads

- Shelf load: 100 kg
- Bay load: 800 kg
- Ideal for storing bins, small parts and loose items
- Assembly without beams, with cross bracing
- Optimum subdivision of shelf space with dividers that slot into the shelf perforations on the long sides
- Fast and easy assembly without bolts saves time
- Extensions possible at any time
- Shelf levels adjustable in 25 mm increments
- All loads indicated refer to uniformly distributed loads



SHELVING

→ See our wide range of bins & containers from page 22

**TOP SELLER!**  
10-52947



Width of starter bay  
1058 mm  
1358 mm

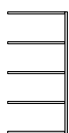

Width of extension bay  
1008 mm  
1308 mm

**Set offer including 1 starter bay and 1 extension bay**

supplied with 5 shelves each  
H x W x D: 2000 x 2066 x 524 mm  
Ref. no. 10-52947

Shelving height <i>mm</i>	Number of shelves	External bay depth <i>mm</i>	Useable depth <i>mm</i>	Shelf width		Shelving type	
				1000 mm	1300 mm	Starter bay	Extension bay
				Ref. no.	Ref. no.	Ref. no.	Ref. no.
2000	5	324	300	10-17024	10-17029	10-17034	10-17039
		424	400	10-17025	10-17030	10-17035	10-17040
		524	500	10-17026	10-17031	10-17036	10-17041
		624	600	10-17027	10-17032	10-17037	10-17042
2500	6	324	300	10-17044	10-17049	10-17054	10-17059
		424	400	10-17045	10-17050	10-17055	10-17060
		524	500	10-17046	10-17051	10-17056	10-17061
		624	600	10-17047	10-17052	10-17057	10-17062

### Accessories



**A** Additional shelves

→ Safety accessories such as anchor bolts and wall mounting sets on page 171

Pos.	Description		Shelf width		
			1000 mm	1300 mm	
			For a shelving depth of <i>mm</i>	Ref. no.	Ref. no.
<b>A</b>	Shelf, 40 mm high	set includes 4 shelf clips, shelf height 40 mm, with shelf perforations for dividers	300	10-17064	10-17069
			400	10-17065	10-17070
			500	10-16963	10-17071
			600	10-17066	10-17072

## Light duty shelving type L - shelf load 100 kg

galvanised finish

Easy to assemble, functional and versatile

- Shelf load: 100 kg
- Bay load: 1300 kg - 1600 kg
- Ideal for storing bins, small parts and loose items
- Assembly with beams and cross bracing
- Optimum subdivision of shelf space with dividers that slot into the shelf perforations on the long sides
- Fast and easy assembly without bolts saves time
- Extensions possible at any time
- Shelf levels adjustable in 25 mm increments
- All loads indicated refer to uniformly distributed loads



SHELVING



See our wide range of bins & containers from page 22



Width of starter bay  
1058 mm  
1358 mm

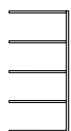

Width of extension bay  
1008 mm  
1308 mm

**TOP SELLER**

10-52948

**Set offer including 1 starter bay and 1 extension bay**

supplied with 5 shelves each  
H x W x D: 2000 x 2066 x 524 mm  
Ref. no. 10-52948

**Extension bay**

with 5 shelves  
H x W x D: 2000 x 1008 x 524 mm  
Ref. no. 10-17181

Shelving height <i>mm</i>	Bay load <i>kg</i>	Number of shelves	External bay depth <i>mm</i>	Useable depth <i>mm</i>	Shelf width 1000 mm		Shelf width 1300 mm	
					Shelving type Starter bay	Shelving type Extension bay	Shelving type Starter bay	Shelving type Extension bay
					Ref. no.	Ref. no.	Ref. no.	Ref. no.
2000	1300	5	324	300	10-17174	10-17179	10-17184	10-17189
			424	400	10-17175	10-17180	10-17185	10-17190
			524	500	10-17176	10-17181	10-17186	10-17191
			624	600	10-17177	10-17182	10-17187	10-17192
2500	1430	6	324	300	10-17194	10-17199	10-17204	10-17209
			424	400	10-17195	10-17200	10-17205	10-17210
			524	500	10-17196	10-17201	10-17206	10-17211
			624	600	10-17197	10-17202	10-17207	10-17212
3000	1600	7	324	300	10-17214	10-17219	10-17224	10-17229
			424	400	10-17215	10-17220	10-17225	10-17230
			524	500	10-17216	10-17221	10-17226	10-17231
			624	600	10-17217	10-17222	10-17227	10-17232

### Accessories



**A** Additional shelves



Safety accessories such as anchor bolts and wall mounting sets on page 171

Pos.	Description	Shelf width		
		For a shelving depth of <i>mm</i>	1000 mm Ref. no.	1300 mm Ref. no.
<b>A</b>	Shelf, 40 mm high set includes 4 shelf clips, shelf height 40 mm, with shelf perforations for dividers	300	10-17064	10-17069
		400	10-17065	10-17070
		500	10-16963	10-17071
		600	10-17066	10-17072



## Medium duty shelving type M - shelf load 200 kg

galvanised finish

Our versatile range for medium weight duties

- Shelf load: 200 kg
- Bay load: 1300 kg - 1600 kg
- Ideal for storing bins, small parts and loose items
- Assembly with beams and cross bracing
- Optimum subdivision of shelf space with dividers that slot into the shelf perforations on the long sides
- Fast and easy assembly without bolts saves time
- Extensions possible at any time
- Shelf levels adjustable in 25 mm increments
- All loads indicated refer to uniformly distributed loads



SHELVING

→ The ideal match: our nestable and stackable BITOBOX MB containers can be found from page 82

**TOP SELLER**  
10-52949

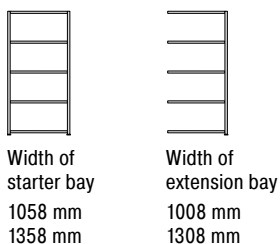

**Set offer including 1 starter bay and 1 extension bay**

supplied with 5 shelves each  
H x W x D: 2000 x 2066 x 524 mm  
Ref. no. 10-52949

**Extension bay**

with 5 shelves  
H x W x D: 2000 x 1008 x 524 mm  
Ref. no. 10-17091

Shelving height <i>mm</i>	Bay load <i>kg</i>	Number of shelves	External bay depth <i>mm</i>	Useable depth <i>mm</i>	Shelf width 1000 mm		Shelf width 1300 mm	
					Shelving type	Ref. no.	Ref. no.	Ref. no.
2000	1300	5	324	300	10-17084	10-17089	10-17094	10-17099
				400	10-17085	10-17090	10-17095	10-17100
				500	10-17086	10-17091	10-17096	10-17101
				600	10-17087	10-17092	10-17097	10-17102
				800	10-17088	10-17093	10-17098	10-17103
2500	1430	6	324	300	10-17104	10-17109	10-17114	10-17119
				400	10-17105	10-17110	10-17115	10-17120
				500	10-17106	10-17111	10-17116	10-17121
				600	10-17107	10-17112	10-17117	10-17122
				800	10-17108	10-17113	10-17118	10-17123
3000	1600	7	324	300	10-17124	10-17129	10-17134	10-17139
				400	10-17125	10-17130	10-17135	10-17140
				500	10-17126	10-17131	10-17136	10-17141
				600	10-17127	10-17132	10-17137	10-17142
				800	10-17128	10-17133	10-17138	10-17143

### Accessories



**A** Additional shelves

→ Safety accessories such as anchor bolts and wall mounting sets on page 171

Pos.	Description		Shelf width		
			For a shelving depth of <i>mm</i>	Ref. no.	Ref. no.
<b>A</b>	Shelf, 40 mm high	set includes 4 shelf clips, shelf height 40 mm, with shelf perforations for dividers	300	10-17074	10-17079
			400	10-17075	10-17080
			500	10-17076	10-17081
			600	10-17077	10-17082
			800	10-17078	10-17083

## Heavy duty shelving type S - shelf load 300 kg

galvanised finish

Our heavy duty option

- Shelf load: 300 kg
- Bay load: 1300 kg - 1600 kg
- Ideal for storing bins, small parts and loose items
- Assembly with beams and cross bracing
- Optimum subdivision of shelf space with dividers that slot into the shelf perforations on the long sides
- Fast and easy assembly without bolts saves time
- Extensions possible at any time
- Shelf levels adjustable in 25 mm increments
- All loads indicated refer to uniformly distributed loads



SHELVING



See our wide range of bins & containers from page 22

**TOP SELLER**

10-52950



Width of starter bay  
1058 mm



Width of extension bay  
1008 mm

**Set offer including 1 starter bay and 1 extension bay**

supplied with 5 shelves each  
H x W x D: 2000 x 2066 x 524 mm  
Ref. no. 10-52950

**Extension bay**

with 5 shelves  
H x W x D: 2000 x 1008 x 524 mm  
Ref. no. 10-17591

Shelving height <i>mm</i>	Bay load <i>kg</i>	Number of shelves	External bay depth <i>mm</i>	Shelf width	1000 mm	
				Shelving type	Starter bay	Extension bay
				Useable depth <i>mm</i>	Ref. no.	Ref. no.
2000	1300	5	424	400	10-17588	10-17589
			524	500	10-17590	10-17591
			624	600	10-17592	10-17593
2500	1430	6	424	400	10-17594	10-17595
			524	500	10-17596	10-17597
			624	600	10-17598	10-17599
3000	1600	7	424	400	10-18116	10-18119
			524	500	10-18117	10-18120
			624	600	10-18118	10-18121

### Accessories



**A** Additional shelves



Safety accessories such as anchor bolts and wall mounting sets on page 171

Pos.	Description		Shelf width	1000 mm
			For a shelving depth of <i>mm</i>	Ref. no.
<b>A</b>	Shelf, 40 mm high	set includes 4 shelf clips, shelf height 40 mm, with shelf perforations for dividers	400	10-17584
			500	10-17585
			600	10-17586

## Shelving with extra large chipboard shelves

galvanised finish

Odd-shaped goods? This is your shelving!

- Shelf load: 350 kg
- Bay load: max. 1600 kg
- Ideal for storing large and bulky goods
- Shelf levels consist of beams and drop-in chipboard panels
- Assembly with beams, without cross bracing
- Fast and easy assembly without bolts saves time
- Extensions possible at any time
- Levels adjust in height on a 25 mm pitch
- All loads indicated refer to uniformly distributed loads



Uprights galvanised



Width of starter bay  
1562 mm  
2066 mm

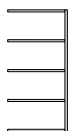

Width of extension bay  
1512 mm  
2016 mm

Set offer including 1 starter bay and 1 extension bay:

supplied with 2 shelf levels each  
H x W x D: 2000 x 4082 x 624 mm  
Ref. no. 47-52951

**TOP SELLER!**

47-52951

Shelving height <i>mm</i>	Number of levels	External bay depth <i>mm</i>	Useable depth <i>mm</i>	Bay width		Shelving type	
				1500 mm	2000 mm	Starter bay	Extension bay
				Ref. no.	Ref. no.	Ref. no.	Ref. no.
2000	3	524	500	47-13483	47-13519	47-13501	47-15537
		624	600	47-13486	47-13522	47-13504	47-13540
		824	800	47-13489	47-13525	47-13507	47-13543
2500	4	524	500	47-13492	47-13528	47-13510	47-13546
		624	600	47-13495	47-15531	47-13513	47-13549
		824	800	47-13498	47-15534	47-13516	47-13552

### Accessories

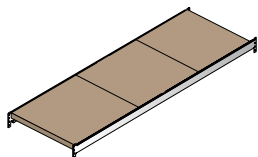

A Additional shelf levels for wide span shelving



Safety accessories such as anchor bolts and wall mounting sets on page 171

Pos.	Description	For a bay width of <i>mm</i>	For a shelving depth of <i>mm</i>	Ref. no.
A	Additional levels for shelving with extra large chipboard shelves, supplied with 2 galvanised beams with support bars and, depending on the bay width, 3 or 4 chipboard panels	1500	500	10-13555
			600	10-13556
			800	10-13557
		2000	500	10-13558
			600	10-13559
			800	10-13560

## Shelving with extra large steel shelves

galvanised finish

Great for goods which need some more space!

- Shelf load: 350 kg
- Bay load: max. 1600 kg
- Ideal for storing large and bulky goods
- Shelf levels consist of beams and drop-in steel panels
- Assembly with beams, without cross bracing
- Fast and easy assembly without bolts saves time
- Extensions possible at any time
- Levels adjust in height on a 25 mm pitch
- All loads indicated refer to uniformly distributed loads



Uprights galvanised



Width of starter bay  
1562 mm  
2066 mm

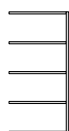

Width of extension bay  
1512 mm  
2016 mm

Set offer including 1 starter bay and 1 extension bay:

supplied with 2 shelf levels each  
H x W x D: 2000 x 4082 x 624 mm  
Ref. no. 47-52952

**TOP SELLER!**

47-52952

Shelving height <i>mm</i>	Number of levels	External bay depth <i>mm</i>	Useable depth <i>mm</i>	Bay width		Shelving type	
				1500 mm	2000 mm	Starter bay	Extension bay
				Ref. no.	Ref. no.	Ref. no.	Ref. no.
2000	3	524	500	47-27100	47-27112	47-16428	47-16432
		624	600	47-27101	47-27113	47-16436	47-16440
		824	800	47-27102	47-27114	47-16444	47-16448
2500	4	524	500	47-27124	47-27136	47-16455	47-16459
		624	600	47-27125	47-27137	47-16463	47-16467
		824	800	47-27126	47-27138	47-16471	47-16475

### Accessories

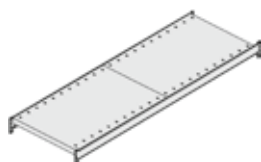

**A** Additional shelf levels for wide span shelving



Safety accessories such as anchor bolts and wall mounting sets on page 171

Pos.	Description	For a bay width of <i>mm</i>	For a shelving depth of <i>mm</i>	Ref. no.
<b>A</b>	Additional shelf levels for shelving with extra large steel shelves, supplied with 2 galvanised beams with adapters and 2 steel panels	1500	500	10-27148
			600	10-27149
			800	10-27150
		2000	500	10-16425
			600	10-16426
			800	10-16427



## Supply shelving

single depth, straight shelves, galvanised finish

Make sure you never run out of supplies ...

- **Shelf load: 100 kg**
- **Bay load: 800 kg**
- **Suited for double sided use**
- **Ideal for supplying workstations with parts and components**
- **Assembly with beams, without cross bracing**
- **Shelves are supported by beams for added stability and strength**
- **Fast and easy assembly without bolts saves time**
- **Extensions possible at any time**
- **Shelf levels adjustable in 25 mm increments**
- **All loads indicated refer to uniformly distributed loads**



→ Suitable bins from page 54

**TOP SELLER!**  
10-23624

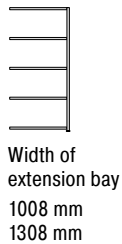
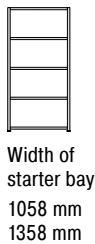

### Starter bay

H x W x D: 2000 x 1358 x 624 mm  
Ref. no. 10-23624

Shelving height <i>mm</i>	Number of shelves	External bay depth <i>mm</i>	Useable depth <i>mm</i>	Shelf width 1000 mm		Shelf width 1300 mm	
				Shelving type Starter bay Ref. no.	Shelving type Extension bay Ref. no.	Shelving type Starter bay Ref. no.	Shelving type Extension bay Ref. no.
2000	4	424	400	10-23576	10-23577	10-23620	10-23621
		524	500	10-23578	10-23579	10-23622	10-23623
		624	600	10-23580	10-23581	10-23624	10-23625
		824	800	10-23582	10-23583	10-23626	10-23627

## Accessories



A Additional levels

→ Safety accessories such as anchor bolts and wall mounting sets on page 171

Pos.	Description	Shelf width		
		For a shelving depth of <i>mm</i>	1000 mm Ref. no.	1300 mm Ref. no.
A	Additional levels single depth shelf levels, single depth shelving, straight shelf levels	400	10-23584	10-23628
		500	10-23585	10-23629
		600	10-23586	10-23630
		800	10-23587	10-23631

## Supply shelving

single depth, inclined shelves, galvanised finish

Great for goods which need some more space!

- Shelf load: 350 kg
- Bay load: max. 1600 kg
- Ideal for storing large and bulky goods
- Shelf levels consist of beams and drop-in steel panels
- Assembly with beams, without cross bracing
- Fast and easy assembly without bolts saves time
- Extensions possible at any time
- Levels adjust in height on a 25 mm pitch
- All loads indicated refer to uniformly distributed loads

Inclination approx. 10°

**TOP SELLER!**

10-52968

**Starter bay**

H x W x D: 2000 x 1358 x 624 mm

Ref. no. 10-52968



SHELVING



Suitable bins from page 54



Width of starter bay  
1058 mm  
1358 mm

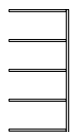

Width of extension bay  
1008 mm  
1308 mm

Shelving height <i>mm</i>	Number of shelves	External bay depth <i>mm</i>	Useable depth <i>mm</i>	Shelf width		Shelving type	
				1000 mm	1300 mm	Starter bay	Extension bay
				Ref. no.	Ref. no.	Ref. no.	Ref. no.
2000	4	424	400	10-52956	10-52957	10-52964	10-52965
		524	500	10-52958	10-52959	10-52966	10-52967
		624	600	10-52960	10-52961	10-52968	10-52969
		824	800	10-52962	10-52963	10-52970	10-52971

### Accessories



**A** Additional levels



Safety accessories such as anchor bolts and wall mounting sets on page 171

Pos.	Description	Shelf width	1000 mm	1300 mm
			For a shelving depth of <i>mm</i>	Ref. no.
<b>A</b>	Additional levels single depth shelf levels, single depth shelving, inclined shelf levels	400	10-23572	10-23616
		500	10-23573	10-23617
		600	10-23574	10-23618
		800	10-23575	10-23619

## Supply shelving

double depth, rear shelf straight, front shelf inclined, galvanised finish

Designed to suit all applications

- Shelf load: 100 kg
- Bay load: 800 kg
- Suited for double sided use
- Easy-to-view product presentation, easy access and ergonomic retrieval
- Assembly with beams, without cross bracing
- Shelves are supported by beams for added stability and strength
- Side lips and raised front prevent storage units from jamming or dropping
- Fast and easy assembly without bolts saves time
- Extensions possible at any time
- Shelf levels adjustable in 25 mm increments
- All loads indicated refer to uniformly distributed loads



Inclination approx. 10°

**TOP SELLER**

10-52984

**Starter bay**

H x W x D: 2000 x 1358 x 1250 mm

Ref. no. 10-52984



Suitable bins from page 54



Width of starter bay  
1058 mm  
1358 mm



Width of extension bay  
1008 mm  
1308 mm

Shelving height	Number of shelves	External bay depth	Useable depth	Shelf width 1000 mm		Shelf width 1300 mm	
				Starter bay	Extension bay	Starter bay	Extension bay
mm		mm	mm	Ref. no.	Ref. no.	Ref. no.	Ref. no.
2000	4	850	800	10-52972	10-52973	10-52980	10-52981
		1050	1000	10-52974	10-52975	10-52982	10-52983
		1250	1200	10-52976	10-52977	10-52984	10-52985
		1650	1600	10-52978	10-52979	10-52986	10-52987

## Accessories



**A** Additional levels



Safety accessories such as anchor bolts and wall mounting sets on page 171

Pos.	Description	Shelf width	1000 mm	1300 mm
			For a shelving depth of mm	Ref. no.
<b>A</b>	Additional levels double depth shelf levels, rear shelf straight, front shelf inclined, supplied with 2 shelves, galvanised	800	10-23560	10-23604
		1000	10-23561	10-23605
		1200	10-23562	10-14696
		1600	10-23563	10-23607

## Supply shelving

double depth, rear and front shelf inclined, galvanised finish

Storage in FIFO order and reliable product supply

- Shelf load: 100 kg
- Bay load: 800 kg
- Suited for double sided use
- Easy-to-view product presentation, easy access and ergonomic retrieval
- Assembly with beams, without cross bracing
- Shelves are supported by beams for added stability and strength
- Side lips and raised front prevent storage units from jamming or dropping
- Fast and easy assembly without bolts saves time
- Extensions possible at any time
- Shelf levels adjustable in 25 mm increments
- All loads indicated refer to uniformly distributed loads



**TOP SELLER**  
10-53000

### Starter bay

H x W x D: 2000 x 1358 x 1250 mm  
Ref. no. 10-53000

→ Suitable bins from page 54



Width of starter bay  
1058 mm  
1358 mm

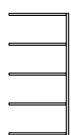

Width of extension bay  
1008 mm  
1308 mm

Shelving height	Number of shelves	External bay depth	Useable depth	Shelf width 1000 mm		Shelf width 1300 mm	
				Starter bay	Extension bay	Starter bay	Extension bay
<i>mm</i>		<i>mm</i>	<i>mm</i>	Ref. no.	Ref. no.	Ref. no.	Ref. no.
2000	4	850	800	10-52988	10-52989	10-52996	10-52997
		1050	1000	10-52990	10-52991	10-52998	10-52999
		1250	1200	10-52992	10-52993	10-53000	10-53001
		1650	1600	10-52994	10-52995	10-53002	10-53003

## Accessories

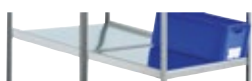

A Additional levels



Safety accessories such as anchor bolts and wall mounting sets on page 171

Pos.	Description	Shelf width			
		For a shelving depth of	1000 mm	1300 mm	
		<i>mm</i>	Ref. no.	Ref. no.	
A	Additional levels	double depth shelf levels, rear and front shelf inclined, supplied with 2 shelves, galvanised	800	10-23548	10-23594
		1000	10-23549	10-23595	
		1200	10-23550	10-14699	
		1600	10-23551	10-23597	





## Shelving with inclined shelves

shelf level incline 30°

Perfect product presentation

- Shelf load: 100 kg
- Bay load: 800 kg
- Ideal for picking items from bins and containers
- Assembly with beams, without cross bracing
- Inclined position of bins allows a better overview and faster ergonomic picking
- Easy picking, as stocked items always move to the picking face
- Fast and easy assembly without bolts saves time
- Extensions possible at any time
- Levels adjust in height on a 25 mm pitch
- All loads indicated refer to uniformly distributed loads

**Inclination 30°**



Set offer including 1 starter bay and 1 extension bay:

supplied with 3 inclined shelf levels each  
H x W x D : 1850 x 2666 x 524 mm  
Ref. no.: 10-52953

**TOP SELLER**

10-52953



BITOBOX BN containers to suit this solution from page 64

Shelving height <i>mm</i>	Number of shelves	External bay depth <i>mm</i>	Useable depth <i>mm</i>	Shelf width	Shelving type	
				1300 mm	Set offer including 1 starter bay and 1 extension bay	Starter bay
				Ref. no.	Ref. no.	Ref. no.
1850	3	524	570	10-52953	10-52954	10-52955

### Accessories



A Inclined shelves



Safety accessories such as anchor bolts and wall mounting sets on page 171

Pos.	Description	For a shelf length of <i>mm</i>	For a shelving depth of <i>mm</i>	Ref. no.
A	Inclined shelves supplied with 2 stiffening beams, galvanised, load capacity 100 kg	1300	570	10-7704

## Shelving with inclined shelves

Shelf trolleys, shelf level incline 30°

Mobile product supply

- Shelf load: 100 kg
- Bay load: 500 kg
- Ideal for picking items from bins and containers
- Mobile shelving units provide more flexibility in picking zones
- The ergonomically designed push handle and easy-to-move fixed and swivel castors provide excellent mobility
- Inclined position of bins allows a better overview and faster ergonomic picking
- Easy picking, as stocked items always move to the picking face
- All loads indicated refer to uniformly distributed loads



**Inclination 30°**

Shelving height <i>mm</i>	Number of shelves	External bay depth <i>mm</i>	Useable depth <i>mm</i>	Shelf width <i>mm</i>	Description	Ref. no.
1815	4	533	570	1300	without bins, mobile version	48-15182
					with bins, mobile version	48-15183

## Kanban bin shelving for small parts

with bins, galvanised finish

Save space and time with the new BITO Kanban solution

- Shelf load: 150 kg
- Bay load: 1250 kg
- Ideal for storing C-items
- Ultra flat shelves are real space savers
- Stores 25% more C-items and provides ergonomic access for order pickers
- All bins are supplied with a slide-down window as standard feature. For optional extras such as product feeder panels, cross dividers, safety bars and dust covers refer to CTB bin accessories.
- Shelves can be retro-fitted with a retaining lip at the rear
- All loads indicated refer to uniformly distributed loads



Width of starter bay  
1058 mm

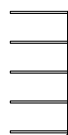

Width of extension bay  
1008 mm



SHELVING



More information on CTB bins on page 38

Shelving height <i>mm</i>	Number of shelves	Description	External bay depth <i>mm</i>	Useable depth <i>mm</i>	Features	Shelf width	Shelving type	
						1000 mm	Starter bay	Extension bay
						Bay load	Ref. no.	Ref. no.
						kg		
1850	10	single sided use	324	300	60 x CTB31514 (300 x 156 x 140 mm)	1250	10-53005	10-53008
			424	400	60 x CTB41514 (400 x 156 x 140 mm)			10-53009
		double sided use	624	600	120 x CTB31514 (300 x 156 x 140 mm)			10-53010

## Kanban bin shelving for small parts

without bins, galvanised finish

More room for your bins – benefit from the flattest shelf on the market

- Shelf load: 150 kg
- Bay load: 1250 kg
- Ultra flat BITO shelves with a height of only 25 mm provide more space for bins
- Ideal for storing C-items
- Ultra flat shelves are real space savers
- Stores 25% more C-items and provides ergonomic access for order pickers
- Shelves can be retro-fitted with a retaining lip at the rear
- Fast and easy assembly without bolts saves time
- Extensions possible at any time
- Shelf levels adjustable in 25 mm increments
- All loads indicated refer to uniformly distributed loads



More accessories from page 168  
Safety accessories such as anchor bolts and wall mounting sets on page 171



Shelving height <i>mm</i>	Number of shelves	External bay depth <i>mm</i>	Useable depth <i>mm</i>	Shelf width	Shelving type	
				1000 mm	Starter bay	Extension bay
				Bay load	Ref. no.	Ref. no.
				kg		
1850	10	324	300	1250	10-53101	10-53104
		424	400			10-53105
		624	600			10-53106

## Boltless shelving complete with RK bins

galvanised finish

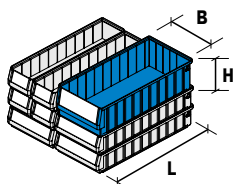

Storage and handling bins RK

Large number of sizes to meet all needs

- Shelf load: 70 kg
- Bay load: 500 kg
- Shelving complete with storage and handling bins RK
- Bin colour: dove blue
- Shelves can be retro-fitted with a retaining lip at the rear
- Assembly with beams and cross bracing
- Fast and easy assembly without bolts saves time
- Extensions possible at any time
- Shelf levels adjustable in 25 mm increments
- All loads indicated refer to uniformly distributed loads



Storage and handling bins RK on page 43, 45

SHELVING

Number of shelves	Features	Shelving type	Starter bay	Extension bay
		Dimensions H x W x D <i>mm</i>	Ref. no.	Ref. no.
12	32 x RK3109 (300 x 117 x 90 mm) 16 x RK3209 (300 x 234 x 90 mm) 16 x RK3214 (300 x 234 x 140 mm)	1850 x 1000 x 324	12-53011	12-53012
	32 x RK4109 (400 x 117 x 90 mm) 16 x RK4209 (400 x 234 x 90 mm) 16 x RK4214 (400 x 234 x 140 mm)	1850 x 1000 x 424	12-53013	12-53014
	32 x RK5109 (500 x 117 x 90 mm) 16 x RK5209 (500 x 234 x 90 mm) 16 x RK5214 (500 x 234 x 140 mm)	1850 x 1000 x 524	12-53015	12-53016
	32 x RK6109 (600 x 117 x 90 mm) 16 x RK6209 (600 x 234 x 90 mm) 16 x RK6214 (600 x 234 x 140 mm)	1850 x 1000 x 624	12-21510	12-21511

Number of shelves	Features	Shelving type	Starter bay	Extension bay
		Dimensions H x W x D <i>mm</i>	Ref. no.	Ref. no.
10	40 x RK3214 (300 x 234 x 140 mm)	1850 x 1000 x 324	12-53017	12-53018
	40 x RK4214 (400 x 234 x 140 mm)	1850 x 1000 x 424	12-53019	12-53020
	40 x RK5214 (500 x 234 x 140 mm)	1850 x 1000 x 524	12-53021	12-53022
	40 x RK6214 (600 x 234 x 140 mm)	1850 x 1000 x 624	12-53023	12-53024

Number of shelves	Features	Shelving type	Starter bay	Extension bay
		Dimensions H x W x D <i>mm</i>	Ref. no.	Ref. no.
14	56 x RK3209 (300 x 234 x 90 mm)	1850 x 1000 x 324	12-53025	12-53026
	56 x RK4209 (400 x 234 x 90 mm)	1850 x 1000 x 424	12-53027	12-53028
	56 x RK5209 (500 x 234 x 90 mm)	1850 x 1000 x 524	12-53029	12-53030
	56 x RK6209 (600 x 234 x 90 mm)	1850 x 1000 x 624	12-53031	12-53032

Number of shelves	Features	Shelving type	Starter bay	Extension bay
		Dimensions H x W x D <i>mm</i>	Ref. no.	Ref. no.
14	112 x RK3109 (300 x 117 x 90 mm)	1850 x 1000 x 324	12-53033	12-53034
	112 x RK4109 (400 x 117 x 90 mm)	1850 x 1000 x 424	12-53035	12-53036
	112 x RK5109 (500 x 117 x 90 mm)	1850 x 1000 x 524	12-53037	12-53038
	112 x RK6109 (600 x 117 x 90 mm)	1850 x 1000 x 624	12-53039	12-53040

### Accessories

Pos.	Description	For a shelf length of <i>mm</i>	Ref. no.
A	Shelf ledges for 25 mm high shelves, to be inserted between shelf and shelf clips, prevent goods from slipping off the shelf, galvanised	1000	10-52182



A Shelf ledges

## Mobile shelving trolleys

with RK storage and handling bins

Perfect combination

- Shelf load: 70 kg
- Bay load: 600 kg
- Fast and easy assembly without bolts saves time
- All shelving components galvanised
- Shelves can be retro-fitted with a retaining lip at the rear
- All loads indicated refer to uniformly distributed loads
- Mobile shelving units provide more flexibility in picking zones
- The ergonomically designed push handle and easy-to-move fixed and swivel castors provide excellent mobility
- Shelving complete with storage and handling bins RK
- Bin colour: dove blue



SHELVING

### **i** BITO info

Bin colours as illustrated. Other colours (blue, red, green, yellow) upon request!

Number of shelves	Features	Dimensions H x W x D <i>mm</i>	Ref. no.
10	40 x RK5209 (500 x 234 x 90 mm)	1815 x 1068 x 533	48-52052
	80 x RK5109 (500 x 117 x 90 mm)		48-52060



Storage and handling bins RK on page 43





## Boltless shelving complete with SK bins

galvanised finish

### i BITO info

Bin colours as illustrated. Other colours (blue, red, green, yellow) upon request!



Width of starter bay  
958 mm

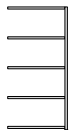

Width of extension bay  
908 mm

SHELVING

### Perfect combination

- Shelf load: 70 kg
- Bay load: 500 kg
- Shelving complete with storage bins SK
- Shelves can be retro-fitted with a retaining lip at the rear
- Assembly with beams and cross bracing
- Fast and easy assembly without bolts saves time
- Extensions possible at any time
- Shelf levels adjustable in 25 mm increments
- All loads indicated refer to uniformly distributed loads

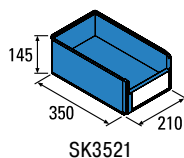

SK3521

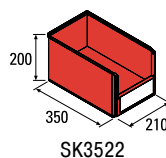

SK3522

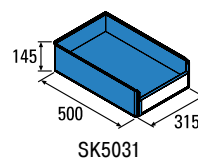

SK5031

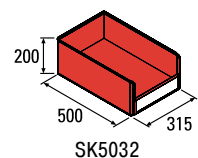

SK5032



### With 40 storage bins SK

Number of shelves	Features	Shelving type	Starter bay	Extension bay
		Dimensions H x W x D mm	Ref. no.	Ref. no.
10	40 x SK3521 (350 x 210 x 145 mm)	1850 x 900 x 324	12-53041	12-53042

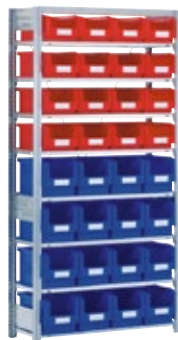

### With 32 storage bins SK

Number of shelves	Features	Shelving type	Starter bay	Extension bay
		Dimensions H x W x D mm	Ref. no.	Ref. no.
8	16 x SK3521 (350 x 210 x 145 mm) 16 x SK3522 (350 x 210 x 200 mm)	1850 x 900 x 324	12-53043	12-53044



### With 30 storage bins SK

Number of shelves	Features	Shelving type	Starter bay	Extension bay
		Dimensions H x W x D mm	Ref. no.	Ref. no.
10	30 x SK5031 (500 x 315 x 145 mm)	1850 x 1000 x 524	12-53045	12-53046



Storage bins SK from page 22, 23



Safety accessories such as anchor bolts and wall mounting sets on page 171

## With 28 storage bins SK

Number of shelves	Features	Shelving type	Starter bay	Extension bay
		Dimensions H x W x D mm	Ref. no.	Ref. no.
7	28 x SK3522 (350 x 210 x 200 mm)	1850 x 900 x 324	12-53047	12-53048



## With 21 storage bins SK

Number of shelves	Features	Shelving type	Starter bay	Extension bay
		Dimensions H x W x D mm	Ref. no.	Ref. no.
7	21 x SK5032 (500 x 315 x 200 mm)	1850 x 1000 x 524	12-53049	12-53050



## Shelf trolleys, with straight shelf levels

- Mobile shelving units provide more flexibility in picking zones
- The ergonomically designed push handle and easy-to-move fixed and swivel castors provide excellent mobility
- Also available in other dimensions: L 1000 x D 500/600/800 mm und L 1300 mm x D 600/800 mm

Number of shelves	Features	Dimensions H x W x D mm	Useable depth mm	Shelf width mm	Ref. no.
7	18 x SK5032 (500 x 315 x 200 mm)	1815 x 1000 x 533	500	1000	48-15721



## Accessories

Pos.	Description	For a shelf length of mm	Ref. no.
A	Shelf ledges for 25 mm high shelves, to be inserted between shelf and shelf clips, prevent goods from slipping off the shelf, galvanised	900	10-52181
		1000	10-52182



A Shelf ledges



Cabinets with hinged doors 110°/180° and with bins from page 364



## Boltless shelving complete with XL bins

Perfect combination

- Shelf load: 100 kg
- Bay load: 800 kg
- Shelving complete with European size stacking containers XL
- Bin colour: blue
- Assembly with beams and cross bracing
- Fast and easy assembly without bolts saves time
- Extensions possible at any time
- Shelf levels adjustable in 25 mm increments
- All loads indicated refer to uniformly distributed loads



Number of shelves	Features	Dimensions H x W x D <i>mm</i>	Ref. no.
5	20 x XL43274 (400 x 300 x 270 mm)	1849 x 1358 x 424	12-55276
6	24 x XL43224 (400 x 300 x 220 mm)		12-55277
8	32 x XL43174 (400 x 300 x 170 mm)		12-55278
4	12 x XL64424 (600 x 400 x 420 mm)	1849 x 1358 x 624	12-55283
5	15 x XL64274 (600 x 400 x 270 mm)		12-55281
	15 x XL64324 (600 x 400 x 320 mm)		12-55282
6	18 x XL64224 (600 x 400 x 220 mm)		12-55280
8	21 x XL64174 (600 x 400 x 170 mm)		12-55279

## Boltless shelving complete with XL and RK bins

Neat product presentation in office and workshop environments

- Shelf load: 100 kg
- Bay load: 800 kg
- Shelving complete with European size stacking containers XL and storage and handling bins RK
- Bin colour: blue
- Assembly with beams and cross bracing
- Fast and easy assembly without bolts saves time
- Extensions possible at any time
- Shelf levels adjustable in 25 mm increments
- All loads indicated refer to uniformly distributed loads



Number of shelves	Features	Dimensions H x W x D <i>mm</i>	Ref. no.
5	8 x XL43271 (400 x 300 x 270 mm)	1849 x 1358 x 424	12-55290
6	4 x XL43224 (400 x 300 x 220 mm) 5 x RK4214 (400 x 234 x 140 mm) 11 x RK4109 (400 x 117 x 90 mm)		12-55287
8	16 x XL43224 (400 x 300 x 220 mm) 44 x RK4109 (400 x 117 x 90 mm)		12-55285
5	6 x XL64271 (600 x 400 x 270 mm)	1849 x 1358 x 624	12-55289
6	3 x XL64224 (600 x 400 x 220 mm) 5 x RK6214 (600 x 234 x 140 mm) 11 x RK6109 (600 x 117 x 90 mm)		12-55286
	3 x XL64421 (600 x 400 x 420 mm) 3 x XL64271 (600 x 400 x 270 mm) 3 x XL64171 (600 x 400 x 170 mm) 5 x RK6214 (600 x 234 x 140 mm) 8 x RK61509 (600 x 156 x 90 mm) 11 x RK6109 (600 x 117 x 90 mm)		12-55288
8	12 x XL64224 (600 x 400 x 220 mm) 44 x RK6109 (600 x 117 x 90 mm)		12-55284

## Mobile shelving trolleys

Perfect combination

- Shelf load: 100 kg
- Bay load: 600 kg
- Fast and easy assembly without bolts saves time
- All shelving components galvanised
- Mobile shelving units provide more flexibility in picking zones
- The ergonomically designed push handle and easy-to-move fixed and swivel castors provide excellent mobility
- All loads indicated refer to uniformly distributed loads



SHELVING



Suitable shelving/racking levels on page 174

Number of shelves	Useable depth <i>mm</i>	Dimensions H x W x D <i>mm</i>	Ref. no.
4	500	1815 x 1064 x 533	48-55270
		1815 x 1364 x 533	48-55273
	600	1815 x 1064 x 633	48-55271
		1815 x 1364 x 633	48-55274
800	1815 x 1064 x 833	1815 x 1064 x 833	48-55272
		1815 x 1364 x 833	48-55275
7	500	1815 x 1064 x 533	48-15720

## Mobile shelving trolleys

with roller tracks

Ideal for workshops and assembly environments!

- Shelf load: 150 kg
- Bay load: 600 kg
- Perfect for bins sized 400 x 300 mm (LxW) - capacity: 32 bins
- Mobile shelving units provide more flexibility in picking zones
- The ergonomically designed push handle and easy-to-move fixed and swivel castors provide excellent mobility
- All loads move gravity-driven on inclined roller tracks to the picking face where they can be picked to requirement



Number of shelves	Useable depth <i>mm</i>	Dimensions H x W x D <i>mm</i>	Ref. no.
5	800	2010 x 1368 x 833	48-55245



## Hose shelving

### galvanised finish

Everything within easy reach!

- Shelf load: 100 kg
- Bay load: 500 kg
- Neat storage of suction and pressure hoses
- Neat storage of suction and pressure hoses of any length
- Trapeze-shaped shelves with integral discharge trough provide non-slip, dry and easily accessible storage space
- Fast and easy assembly without bolts saves time
- Extensions possible at any time
- All loads indicated refer to uniformly distributed loads
- Neat storage of suction and pressure hoses of any length



Width of starter bay  
1058 mm

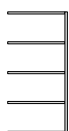

Width of extension bay  
1008 mm

Shelving height <i>mm</i>	Number of shelves	External bay depth <i>mm</i>	Useable depth <i>mm</i>	Shelf width	1000 mm
				Shelving type	Starter bay
				Ref. no.	Ref. no.
2200	3	524	500	17-53051	17-53053
2500	4	524	500	17-53052	17-53054

## Hose shelving

### Shelf trolleys, galvanised finish

- Shelf load: 100 kg
- Bay load: 500 kg
- Facilitates transport of hoses to and from emergency vehicles
- The ergonomically designed push handle and easy-to-move fixed and swivel castors provide excellent mobility
- Trapeze-shaped shelves with integral discharge trough provide non-slip, dry and easily accessible storage space
- Levels adjust in height on a 25 mm pitch
- All loads indicated refer to uniformly distributed loads



Shelving height <i>mm</i>	External bay width <i>mm</i>	External bay depth <i>mm</i>	Number of levels	Castor Ø <i>mm</i>	Surface finish	Ref. no.
1815	1068	524	3	125	galvanised	17-13091

## Accessories

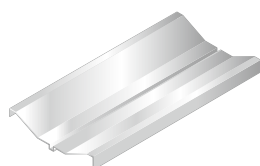

**A** Additional hose levels



Safety accessories such as anchor bolts and wall mounting sets on page 171

Pos.	Description	For a shelf length of <i>mm</i>	For a shelving depth of <i>mm</i>	Ref. no.	
<b>A</b>	Additional hose levels	single depth shelf levels, suited for hose shelving and hose carts	1000	500	17-8246

## Cabinets for fire fighting equipment

Neat and tidy storage allows easy access to items!

- Feet from high-grade plastic for optimum corrosion resistance, feet height 150 mm
- Height adjustable feet included as standard
- Compartment width 400 mm
- Supplied with fold-down helmet support on roof top (supplied unmounted, easy on-site fitting)
- Locker compartment with drop-in slot secured by a cylinder lock
- Open compartments underneath with grid shelf, garment rail with 3 push-along hooks per compartment
- Rail with captive hook for straps, cords, etc.
- Cabinet base with slot for broom cleaning, epoxy-coated finish
- Other colours upon request. (Supports for helmets are always in black RAL 9005.)



SHELVING



More garment lockers from page 376

Height <i>mm</i>	Width <i>mm</i>	Depth <i>mm</i>	Number of compartments	Colour	Ref. no.
2000	420	500	1	RAL 3000 Flame red	17-21380
	810	500	2	RAL 3000 Flame red	17-21381
	1200	500	3	RAL 3000 Flame red	17-21382
	1590	500	4	RAL 3000 Flame red	17-21383

## Boltless shelving with wire baskets - wire baskets

galvanised finish

Neat and easy-to-view product presentation

- Shelf load: 100 kg
- Bay load: 800 kg
- Ideal for storing sewer and heating pipes, lightweight bulk materials and goods that are difficult to stack
- Wire basket 35 kg
- Supplied with solid base shelf
- Assembly with beams and cross bracing
- Fast and easy assembly without bolts saves time
- Extensions possible at any time
- Shelf levels adjustable in 25 mm increments
- All loads indicated refer to uniformly distributed loads

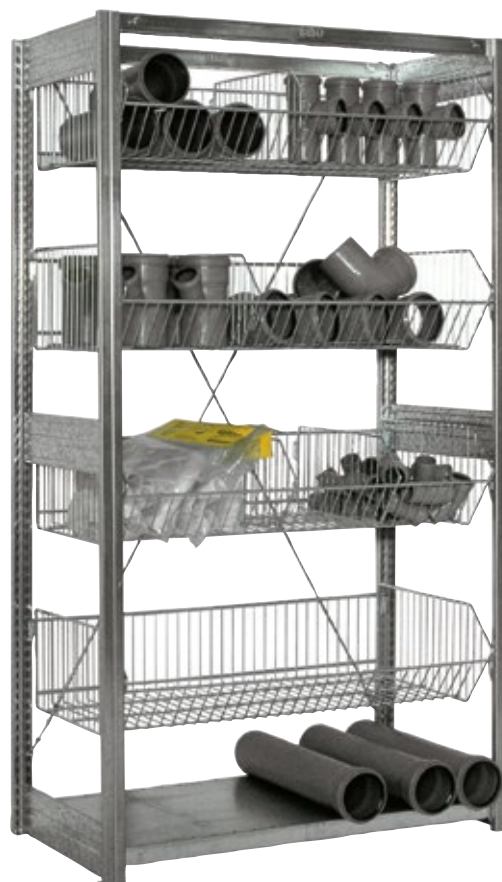

Width of starter bay  
1058 mm



Width of extension bay  
1008 mm

Shelving height <i>mm</i>	Number of levels	External bay depth <i>mm</i>	Useable depth <i>mm</i>	Width of wire baskets	
				Starter bay	Extension bay
				Ref. no.	Ref. no.
1850	4	524	500	10-53055	10-53057
2200	5	524	500	10-53056	10-53058

### Accessories



**A** Shelf, 40 mm high



**B** Wire baskets

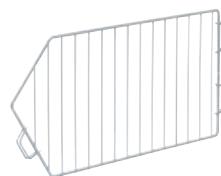

**C** Wire dividers



Safety accessories such as anchor bolts and wall mounting sets on page 171

Pos.	Description	Load capacity <i>kg</i>	For a shelf length of <i>mm</i>	For a shelving depth of <i>mm</i>	Ref. no.
<b>A</b>	Shelf, 40 mm high convenient drop-in fitting on upper stiffening beams	100	1000	500	10-16934
<b>B</b>	Wire baskets height 240 mm, mesh rods with 30 mm spacing, supplied with 4 shelf clips, load capacity per wire basket 35 kg, all loads indicated refer to uniformly distributed loads	35	1000	500	10-13052
<b>C</b>	Wire dividers galvanised, optimum subdivision of wire baskets to suit your products, height 210 mm	-	-	500	10-11682

## Shelving with wire shelves - wire shelves

galvanised finish

Attractive, easy to clean, immediate product overview

- Shelf load: 100 kg
- Bay load: 800 kg
- Wire-mesh shelves allow water, air and light to pass through
- Assembly with beams and cross bracing
- Fast and easy assembly without bolts saves time
- Extensions possible at any time
- Shelf levels adjustable in 25 mm increments
- All loads indicated refer to uniformly distributed loads



SHELVING



Width of starter bay  
1058 mm



Width of extension bay  
1008 mm

Shelving height <i>mm</i>	Number of levels	External bay depth <i>mm</i>	Useable depth <i>mm</i>	Width of wire shelves		Shelving type	
				1000 mm	1300 mm	Starter bay	Extension bay
				Ref. no.	Ref. no.	Ref. no.	Ref. no.
2000	5	524	500	10-53059	10-53061	10-54891	10-54893
2500	6	524	500	10-53060	10-53062	10-54892	10-54894

### Accessories



**A** Wire shelves



Safety accessories such as anchor bolts and wall mounting sets on page 171

Pos.	Description		For a shelf length of		Ref. no.
			<i>mm</i>	<i>mm</i>	
<b>A</b>	Wire shelves shelf height 25 mm, mesh rods with 30 mm spacing, supplied with 4 shelf clips, load capacity per wire shelf 100 kg, all loads indicated refer to uniformly distributed loads		1000	500	10-16489
			1300	500	10-54890



## Corner shelving

galvanised finish

Corner shelving fits in everywhere!

- **Shelf load: 100 kg**
- **Bay load: 1000 kg - 1400 kg**
- **Ideal for creating more storage space in the corners of your premises**
- **Assembly with beams and cross bracing**
- **Fast and easy assembly without bolts saves time**
- **Extensions possible at any time**
- **Shelf levels adjustable in 25 mm increments**
- **All loads indicated refer to uniformly distributed loads**



SHELVING

→ Safety accessories such as anchor bolts and wall mounting sets on page 171

Shelving height <i>mm</i>	Number of shelves	External bay depth <i>mm</i>	Useable depth <i>mm</i>	Top view L x W <i>mm</i>	Ref. no.
2000	10	324	300	1060 x 1354	10-53063
		424	400	1060 x 1454	10-53064
		524	500	1060 x 1554	10-53065
		624	600	1060 x 1654	10-53066
2500	12	324	300	1060 x 1354	10-53067
		424	400	1060 x 1454	10-53068
		524	500	1060 x 1554	10-53069
		624	600	1060 x 1654	10-53070

### Accessories



**A** Light duty shelving type  
L - shelf load 100 kg

Pos.	Description	Shelving height <i>mm</i>	For a shelving depth of <i>mm</i>	Shelf width <i>mm</i>	Ref. no.
<b>A</b>	Extension bay	2000	300	1000	10-17179
			400	1000	10-17180
			500	1000	10-17181
			600	1000	10-17182
		2500	300	1000	10-17199
			400	1000	10-17200
			500	1000	10-17201
			600	1000	10-17202

## Tyre shelving

galvanised finish

Proper and space-saving tyre storage

- Shelf load: 150 - 250 kg
- Bay load: 800 kg
- Ideal for tyre storage
- Suitable for tyre diameters from 578 to 624 mm
- Assembly with beams, without cross bracing
- Fast and easy assembly without bolts saves time
- Extensions possible at any time
- All loads indicated refer to uniformly distributed loads



Width of starter bay  
1058 mm  
1358 mm  
1558 mm



Width of extension bay  
1008 mm  
1308 mm  
1508 mm



SHELVING

Shelf load kg	Bay width mm	Shelving height mm	Number of levels	Shelving type	Starter bay	Extension bay
				External bay depth mm	Ref. no.	Ref. no.
150	1300 mm	1850	3	424	10-53071	10-53072
		2500	4	424	10-53073	10-53074
		3000	5	424	10-53075	10-53076
	1500 mm	1850	3	424	10-53077	10-53078
		2500	4	424	10-53079	10-53080
		3000	5	424	10-53081	10-53082
250	1000 mm	1850	3	424	10-53083	10-53084
		2500	4	424	10-53085	10-53086
		3000	5	424	10-53087	10-53088

## Tyre shelving - Shelf trolley

Shelf trolleys

Proper and space-saving tyre storage

- Shelf load: 150 kg
- Bay load: 300 kg
- Ideal for tyre storage
- Suitable for tyre diameters from 578 to 624 mm
- The ergonomically designed push handle and easy-to-move fixed and swivel castors provide excellent mobility
- 2 storage levels complete with special profile beams designed for gentle storage and in-house transport of tyres and rims
- All loads indicated refer to uniformly distributed loads



Shelving height mm	Shelf width mm	Number of shelves	External bay depth mm	Useable depth mm	Ref. no.
1625	1300	2	682	424	10-40200

## Accessories



A Additional shelves

B Tyre beams

Pos.	Description	For a shelf length of mm	For a shelving depth of mm	Ref. no.
A	Shelf, 40 mm high set includes 4 shelf clips, shelf height 40 mm, with shelf perforations for dividers	1000	400	10-17065
		1300	400	10-17070
B	Tyre beams space-saving storage of tyres and rims, incl. safety pins, galvanised	1000	400	10-7709
		1300	400	10-28540
		1500	400	10-7708

## Accessories for boltless shelving

### Unbegrenzte Möglichkeiten

With ease of assembly, superior workmanship and a broad range of accessories, BITO shelving gets top marks from our customers. Added benefits such as anytime extension, reconfiguration and retro-fitting make BITO boltless shelving a real winner!



SHELVING



### Shelving components

- ① Frames
- ② Stiffening beam
- ③ Cross bracing
- ④ Shelves (with shelf clips)

#### Shelving rows:

- a with stiffening beams = 1 cross bracing set for every fifth bay, maximum bay load capacity 1600 kg
- b without stiffening beams = 1 cross bracing set for every second bay, maximum bay load capacity 800 kg

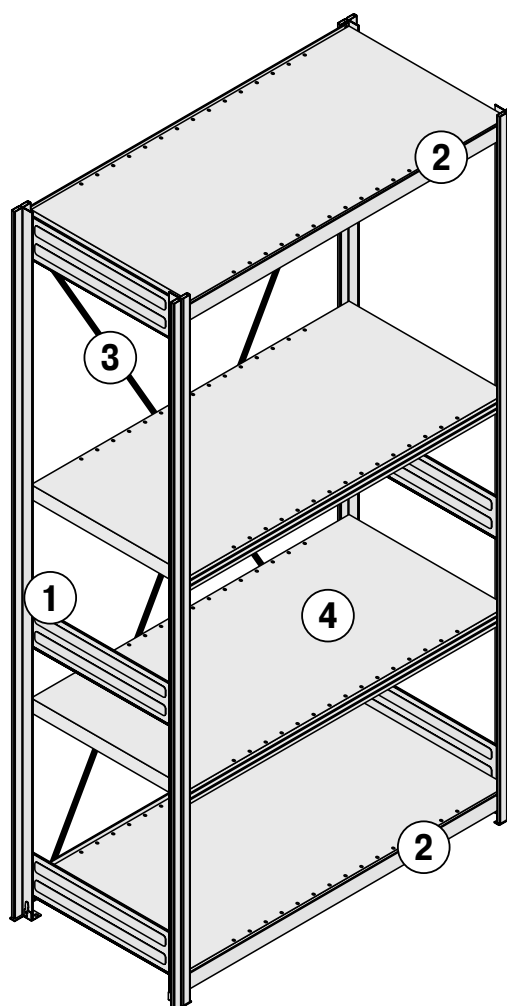

## Frames

Our accessories fit any application

- **Modular system, add-ons possible whenever required**

### Frames for boltless shelving, unassembled

- Supplied with 2 uprights, 3 to 5 upright connectors, 2 base plates
- All components galvanised

Height	1850 mm	2000 mm	2200 mm	2500 mm	3000 mm
External bay depth	Ref. no.	Ref. no.	Ref. no.	Ref. no.	Ref. no.
<i>mm</i>					
324	10-15065	10-13635	10-15081	10-13639	10-15097
424	10-15066	10-13636	10-15082	10-13640	10-15098
524	10-15067	10-13637	10-15083	10-13641	10-15099
624	10-15068	10-13638	10-15084	10-13642	10-15100
824	10-15069	10-15070	10-15085	10-15086	10-15101

### Frames for boltless shelving, unassembled

**RAL 5010**

- Supplied with 2 uprights, 3 to 5 upright connectors, 2 base plates
- Uprights are epoxy-coated in gentian blue, RAL 5010, all other components are galvanised

Height	1850 mm	2000 mm	2200 mm	2500 mm	3000 mm
External bay depth	Ref. no.	Ref. no.	Ref. no.	Ref. no.	Ref. no.
<i>mm</i>					
324	10-45320	10-45325	10-45330	10-45335	10-45340
424	10-45322	10-45326	10-45331	10-45336	10-45341
524	10-45321	10-45327	10-45332	10-45337	10-45342
624	10-45323	10-45328	10-45333	10-45338	10-45343
824	10-45324	10-45329	10-45334	10-45339	10-45344

### Frames for boltless shelving, unassembled

**RAL 7035**

- Supplied with 2 uprights, 3 to 5 upright connectors, 2 base plates
- Uprights epoxy-coated in light grey, RAL 7035, all other components galvanised

Height	1850 mm	2000 mm	2200 mm	2500 mm	3000 mm
External bay depth	Ref. no.	Ref. no.	Ref. no.	Ref. no.	Ref. no.
<i>mm</i>					
324	10-45345	10-45350	10-45355	10-45360	10-45365
424	10-45346	10-45351	10-45356	10-45361	10-45366
524	10-45347	10-45352	10-45357	10-45362	10-45367
624	10-45348	10-45353	10-45358	10-45363	10-45368
824	10-45349	10-45354	10-45359	10-45364	10-45369



SHELVING



## Frames



SHELVING



### Frames for boltless shelving, unassembled

**RAL 3000**

- Supplied with 2 uprights, 3 to 5 upright connectors, 2 base plates
- Uprights epoxy-coated in flame red, RAL 3000, all other components galvanised

Height	1850 mm	2000 mm	2200 mm	2500 mm	3000 mm
External bay depth	Ref. no.	Ref. no.	Ref. no.	Ref. no.	Ref. no.
<i>mm</i>					
324	10-45370	10-45375	10-45380	10-45385	10-45390
424	10-45371	10-45376	10-45381	10-45386	10-45391
524	10-45372	10-45377	10-45382	10-45387	10-45392
624	10-45373	10-45378	10-45383	10-45388	10-45393
824	10-45374	10-45379	10-45384	10-45389	10-45394

### Frames for boltless shelving, supplied assembled

- Supplied with 2 uprights, 3 to 5 upright connectors, 2 base plates
- All components galvanised
- **Please note: Extended delivery time**

Height	1850 mm	2000 mm	2200 mm	2500 mm	3000 mm
External bay depth	Ref. no.	Ref. no.	Ref. no.	Ref. no.	Ref. no.
<i>mm</i>					
324	10-C1200-0201	10-15000	10-15015	10-15004	10-15010
424	10-C1200-0202	10-15001	10-15016	10-15005	10-15011
524	10-C1200-0203	10-15002	10-15017	10-15006	10-15012
624	10-C1200-0206	10-15003	10-15018	10-15007	10-15013
824	10-C1200-0204	10-15008	10-15019	10-15009	10-15014

## Accessories

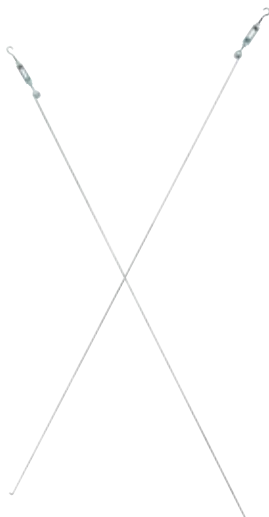

### Cross bracing

- Consisting of 2 struts and 2 turnbuckles
- Shelving runs with stiffening beams require cross bracing in every fifth bay, shelving runs without stiffening beams require cross bracing in every other bay
- Galvanised

For a shelf length of	Ref. no.
<i>mm</i>	
750	10-26870
1000/1300	10-7713



Safety accessories such as anchor bolts and wall mounting sets on page 171

## Side cladding, solid steel sheet panel

- Consisting of 2 to 3 segments depending on frame height, supplied with fixing clips
- Frame not included. **Please order unassembled frames separately!**

Height	2000 mm	2200 mm	2500 mm	3000 mm
External bay depth	Ref. no.	Ref. no.	Ref. no.	Ref. no.
<i>mm</i>				
324	10-13620	10-19054	10-13625	10-13630
424	10-13621	10-19055	10-13626	10-13631
524	10-13622	10-19056	10-13627	10-13632
624	10-13623	10-19057	10-13628	10-13633
824	10-13624	10-19058	10-13629	10-13634

## Side cladding, wire-mesh panels

- Mesh width 50 x 50 mm, incl. fixing clips
- Frame not included. **Please order unassembled frames separately!**

Height	2000 mm	2200 mm	2500 mm	3000 mm
External bay depth	Ref. no.	Ref. no.	Ref. no.	Ref. no.
<i>mm</i>				
324	10-12299	10-14366	10-12304	10-12309
424	10-12300	10-14367	10-12305	10-12310
524	10-12301	10-14368	10-12306	10-12311
624	10-12302	10-14369	10-12307	10-12312
824	10-12303	10-14370	10-12308	10-12313

## Shims, galvanised

- For compensating floor unevenness

Description	Worktop thickness	Pcs/pack	Ref. no.
	<i>mm</i>		
suited for shelving galvanised	1	20	10-12215
	3	20	10-12216

## Wall fixing brackets, for frames

- Used to fix shelving units to the wall, spacing can be adjusted without increments up to 200 mm
- Delivery includes fixing material

Description	Ref. no.
galvanised	10-17547

## Anchor bolts, for frames

- No additional anchor bolts required

Material	Pcs/pack	Ref. no.
steel	10	41-15871

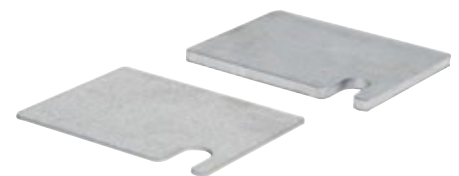

### **i** BITO info

**Shelving & racking must be sufficiently secured against tip-overs if:**

- the height of the top shelf in relation to the shelving depth is greater than 5:1
- shelving is equipped with hinged doors with a height/depth ratio greater than 4:1
- shelving is equipped with pull-out elements (e.g. drawers) and in the case of shelving with ladders



SHELVING

### Louvered panels

suited for rack mounting

- Easy-to-mount, hardwearing steel sheet panels
- Designed to accommodate storage bins SK1095, SK1610 and SK2311



SHELVING



Storage bins SK from page 22, 23

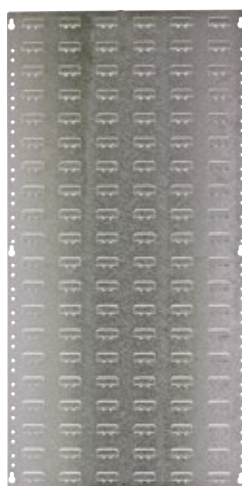

#### Fitted to shelving sides

For a shelving depth of <i>mm</i>	Height <i>mm</i>	Ref. no.
300	1000	8-31329
400	1000	8-31330
500	500	8-31333
	1000	8-31331
600	1000	8-31332
Fixing material	1 set contains 12 bolts M5 and 12 nuts for mounting a louvered panel to the shelving sides	8-56505

#### Fitted to shelving back

For a shelf length of <i>mm</i>	Height <i>mm</i>	Ref. no.
1000	500	8-31326
	1000	8-31327
1300	1000	8-31328
Fixing material	spring clips, please order 6/12 pcs. per louvered panel (500 mm/1000 mm high) to fix panel to shelving	10-12290

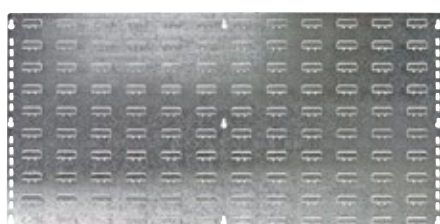

## Back cladding

galvanised finish

### Back cladding, solid steel sheet panel

- 2 or 3 segments required depending on frame height
- Can also be used as partition in back-to-back shelving
- Supplied with fixing clips
- Galvanised

Height	2000 mm	2200 mm	2500 mm	3000 mm
Width	Ref. no.	Ref. no.	Ref. no.	Ref. no.
mm				
750	10-29260	10-29261	10-29262	10-29263
1000	10-17162	10-14261	10-17163	10-17164
1300	10-17165	10-14262	10-17166	10-17167



SHELVING

### Back cladding, wire-mesh panels

- Can also be used as partition in back-to-back shelving
- Grid infill 50 x 50 mm
- Supplied with fixing clips
- Galvanised

Height	1950 mm	2150 mm	2450 mm	2950 mm
Width	Ref. no.	Ref. no.	Ref. no.	Ref. no.
mm				
1000	10-17168	10-14396	10-17169	10-17170
1300	10-17171	10-14397	10-17172	10-17173

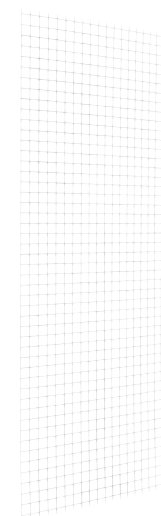

### Shelf clips, galvanised finish, height 40 mm and 25 mm

- 4 shelf clips required per shelf
- Shelf levels adjustable in 25 mm increments

Description	Pcs/pack	Ref. no.
Shelf clips	4	10-3798





## Shelves

galvanised finish, height 40 mm and 25 mm



SHELVING



### 40 mm high

- Shelf height 40 mm
- With shelf perforations for dividers
- Supplied with 4 shelf clips
- All loads indicated refer to uniformly distributed loads

Colour	For a shelving depth of <i>mm</i>	For a shelf length of <i>mm</i>	load capacity		
			100 kg Ref. no.	200 kg Ref. no.	300 kg Ref. no.
galvanised	300	750		10-26840	
		1000	10-17064	10-17074	
		1300	10-17069	10-17079	
	400	750		10-26841	
		1000	10-17065	10-17075	10-17584
		1300	10-17070	10-17080	
	500	750		10-26842	
		1000	10-16963	10-17076	10-17585
		1300	10-17071	10-17081	
	600	750		10-26843	
		1000	10-17066	10-17077	10-17586
		1300	10-17072	10-17082	
800	750		10-26683		
	1000		10-17078		
	1300		10-17083		



### 25 mm high

- Shelf height 25 mm
- With shelf perforations for dividers
- Supplied with 4 shelf clips
- Ultra flat shelves help you make the most of your storage space
- All loads indicated refer to uniformly distributed loads

Colour	For a shelving depth of <i>mm</i>	For a shelf length of <i>mm</i>	Load capacity <i>kg</i>	Ref. no.
galvanised	300	750	70	10-C1165-0036
		1000	70	10-C1165-0006
		1000	150	10-C1165-0008
	400	1000	70	10-C1165-0009
		1000	150	10-C1165-0011
	500	1000	70	10-C1165-0012
		1000	150	10-C1165-0014
	600	1000	70	10-C1165-0015
		1000	150	10-C1165-0017
RAL 7035 Light grey	300	750	70	10-C1165-0077
		1000	70	10-C1165-0078

## Shelf ledges



Stop items from falling off at the rear!

- To be inserted between shelf and shelf clips
- Prevent goods from slipping off the shelf
- Galvanised

Description	For a shelf length of <i>mm</i>	Ref. no.
for 25 mm high shelves	750	10-52180
	900	10-52181
	1000	10-52182
	1300	10-52183
for 40 mm high shelves	1000	10-6568
	1300	10-9831

## Wire shelves GRID

- Allow water to pass through – essential for sprinkler environments/for compliance with fire prevention regulations
- Lower fire insurance premium
- Rectangular slotting
- Compatible with all standard types of BITO boltless shelving
- With shelf perforations on a 50 mm pitch to slot in dividers
- Load capacity 100 kg
- Shelf height 40 mm
- Supplied with 4 shelf clips
- All loads indicated refer to uniformly distributed loads



### Permeability > 50%

- In compliance with safety standard VdS CEA4001 which stipulates that shelves in sprinkler environments must allow at least 50% of the water to pass through

Colour	Load capacity <i>kg</i>	For a shelf length of <i>mm</i>	For a shelving depth of <i>mm</i>	Ref. no.
galvanised	100	1000	400	10-37914
			500	10-37915
			600	10-37916
			800	10-37917
		1300	400	10-37919
			500	10-37920
			600	10-37921
			800	10-37922



### Permeability 44-50%

- Shelves in the dimensions listed below have a water permeability of up to 49%

Colour	Load capacity <i>kg</i>	For a shelf length of <i>mm</i>	For a shelving depth of <i>mm</i>	Ref. no.	
galvanised	100	750	300	10-37908	
			400	10-37909	
			500	10-37910	
			600	10-37911	
		1000	800	10-37912	
			1000	300	10-37913
			1300	300	10-37918



**Beams**

SHELVING

**Stiffening beams**

- Hooked into the slotting pattern of the uprights, safety pins provide protection against unintentional lifting
- Incl. safety pins
- Suited for shelves with a load capacity of 100 kg, 200 kg and 300 kg
- All components galvanised, epoxy coating in RAL colours on request

For a shelf length of <i>mm</i>	Height <i>mm</i>	Ref. no.
750	40	10-26846
1000	40	10-7706
1300	40	10-7711

**Universal beams**

- Special profile bending to allow drop-on fitting of chipboard and wire shelves
- Incl. safety pins
- Galvanised

For a shelf length of <i>mm</i>	Useful interior length <i>mm</i>	Ref. no.
1000	996	10-7707
1300	1296	28-9824

**Tyre beams**

- Space-saving storage of tyres and rims
- Incl. safety pins
- Galvanised

For a shelf length of <i>mm</i>	Useful interior length <i>mm</i>	Load cap. per pair of beams <i>kg</i>	Ref. no.
1000	958	250	10-7709
1300	1258	150	10-28540
1500	1458	150	10-7708

## Shelf dividers

Our accessories fit any application

- **Freestanding divider**
- **Subdivide storage levels into several compartments**
- **Immediate stock identification even if several references are stocked on the same level**

### Full sheet dividers, slot-in fitting, for 40 mm high shelves

- Convenient slot-in fitting into shelf perforations
- Galvanised

Height	100 mm	200 mm	300 mm
For a shelving depth of	Ref. no.	Ref. no.	Ref. no.
mm			
300	10-44690	10-44691	10-44692
400	10-44693	10-44694	10-44695
500	10-44696	10-44697	10-44698
600	10-44699	10-44700	10-44701
800	10-44702	10-44703	10-44704



### Shelf dividers, slot-in fitting, for 25 mm high shelves

- Convenient slot-in fitting into shelf perforations
- Galvanised

Height	100 mm	200 mm	300 mm
For a shelving depth of	Ref. no.	Ref. no.	Ref. no.
mm			
300	10-52213	10-52214	10-52215
400	10-52216	10-52217	10-52218
500	10-52219	10-52220	10-52221
600	10-52222	10-52223	10-52224
800	10-52225	10-52226	10-52227



### Shelf dividers, with label holder, for 40 mm high shelves

- From PVC, height 150 mm
- Optimum subdivision of any shelf, whether fitted with beams or without beams
- Can be positioned anywhere along the shelf length
- Convenient subdivision since dividers slide easily back and forth along the shelf length
- Partitions in yellow are easy to see

Height	For a shelving depth of	Product type	Pcs/pack	Ref. no.
mm	mm			
150	300	FT275	20	10-51009
	400	FT375	20	10-51008
	500	FT475	20	10-51007
	600	FT575	20	10-51006
Label sheets	pre-perforated blank label sheets, ready for direct printing, suited for laser and inkjet printers, on white DIN A4 sheets, 140 g/m <sup>2</sup> , 25 sheets per pack, colour white		25	46-20767





### Bin shelves for loose goods



#### Bin shelves for loose goods

- Back and side panels 200 mm high, front panel 100 mm high
- Can also be combined with sheet metal dividers (height 200 mm)
- Galvanised

for a shelf length of	1000 mm	1300 mm
External bay depth	Ref. no.	Ref. no.
<i>mm</i>		
324	10-14381	10-14386
424	10-14382	10-14387
524	10-14383	10-14388
624	10-14384	10-14389
824	10-14385	10-14390

### Vertical storage



#### Support rails for divider bars

- Can be fitted without bolts, for vertical storage of light-weight goods
- Galvanised
- **Please order divider bars separately!**

For a shelf length of	Ref. no.
<i>mm</i>	
1000	10-15053
1300	10-15054



#### Divider bars for long goods

- Push-on fitting onto beam to allow vertical storage of long loads
- Galvanised

Length	Ref. no.
<i>mm</i>	
400	10-15052

## Wire-mesh partitions

### Wire shelves

- Shelf height 25 mm
- Mesh rods with 30 mm spacing
- Supplied with 4 shelf clips
- Load capacity per wire shelf 100 kg
- All loads indicated refer to uniformly distributed loads

For a shelving depth of <i>mm</i>	For a shelf length of <i>mm</i>	Surface finish	Ref. no.
500	1000	galvanised	10-16489
	1300	galvanised	10-54890



### Wire baskets

- Height 240 mm
- Mesh rods with 30 mm spacing
- Supplied with 4 shelf clips
- Load capacity per wire basket 35 kg
- All loads indicated refer to uniformly distributed loads

For a shelving depth of <i>mm</i>	For a shelf length of <i>mm</i>	Surface finish	Ref. no.
500	1000	galvanised	10-13052



### Wire dividers, for wire baskets

- Galvanised
- Optimum subdivision of wire baskets to suit your products
- Height 210 mm

For a shelving depth of <i>mm</i>	Surface finish	Ref. no.
500	galvanised	10-11682

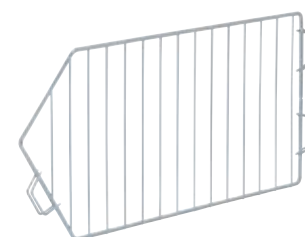

### Tray shelves

- Safe storage of receptacles with spill potential such as open paint cans etc.
- Shelves retain spillage
- Height 60 mm
- Supplied with 4 shelf clips
- Shelf load capacity 200 kg
- All loads indicated refer to uniformly distributed loads

For a shelving depth of <i>mm</i>	For a shelf length of <i>mm</i>	Surface finish	Ref. no.
500	1000	galvanised	10-12937



## Further accessories

galvanised finish, height 40 mm and 25 mm



SHELVING



### Clothes rails (set)

- Delivery includes 2 side supports, 4 shelf clips and a galvanised clothes rail, Ø 32 mm
- Galvanised

for a shelf length of	1000 mm		1300 mm	
External bay depth	Load capacity	Ref. no.	Load capacity	Ref. no.
mm	kg		kg	
424	100	10-55225	100	10-55228
524	100	10-55226	100	10-55229
624	100	10-55227	100	10-55230
824	100	28-55360	100	28-55361



### Suspension file kits

- Suitable for the Leitz system, supplied with of 1 pair of side supports, 1 hanging rail
- ZIPPEL system upon request
- Galvanised

For a shelf length of	For a shelving depth of	Ref. no.
mm	mm	
1000	400	10-12291



### Upright caps

- Prevent injuries in the case of low-built uprights and enhance appearance
- 1 pair required per frame

Material	Colour	Pcs/pack	Ref. no.
PP	black	2	10-16050



### Connectors for back-to-back shelving, galvanised

- Connect adjoining uprights of back-to-back shelving

Description	Ref. no.
galvanised	10-17535



### Foot plinths, galvanised

- To be clipped into stiffening beam to cover the distance between bottom shelf and floor.  
(Please note: the foot plinth can only be used in combination with a stiffening beam.)

Height	For a shelf length of	Ref. no.
mm	mm	
75	1000	10-6625
	1300	10-6624



### Shelf ledges

- To be inserted between shelf and shelf clips
- Prevent goods from slipping off the shelf
- Galvanised

Description	For a shelf length of	Ref. no.
	mm	
for 25 mm high shelves	750	10-52180
	900	10-52181
	1000	10-52182
	1300	10-52183
for 40 mm high shelves	1000	10-6568
	1300	10-9831

## Hinged doors

- Can be retro-fitted
- All components epoxy-coated in light grey, RAL 7035
- Supplied with 2 or 3 door pivots
- Double door with flush fitting turn handle, safety lock and 2 keys (3-point locking mechanism)
- Suited for all types of boltless shelving



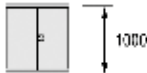
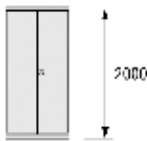
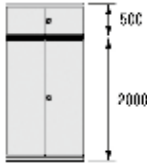
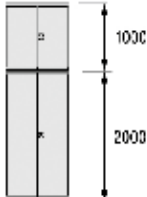

SHELVING

### Hinged doors, width 1000 mm

Configuration	Unit height mm	Ref. no.
	575	10-29954
	1075	10-29952
	2000	10-29950
	2000 + 500	10-29956
	2000 + 1000	10-29958

### Hinged doors, width 1300 mm

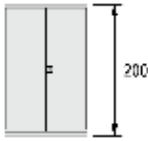
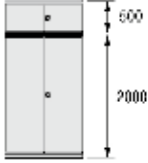
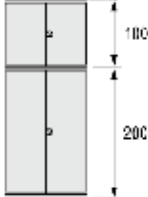
Configuration	Unit height mm	Ref. no.
	575	10-29955
	1075	10-29953
	2000	10-29951
	2000 + 500	10-29957
	2000 + 1000	10-29959





## Retrofit drawers



- Can be retro-fitted
- All components epoxy-coated in light grey, RAL 7035
- 2 drawer sides on fully extending telescopic runners
- Drawer load capacity 60 kg
- Optional locking mechanism
- Optional trough insert
- Suited for bays sized 1000 x 500 mm
- Delivery includes drawer(s) (without shelving)

### Individual drawers

- Supplied with 1 steel sheet drawer with full width hand grip on drawer front
- Without lock



For a shelving depth of <i>mm</i>	Height <i>mm</i>	Ref. no.
524	100	10-15519
	150	10-15518
	200	10-15517



### Drawer blocks with 3 drawers

- Supplied with 3 steel sheet drawers with full width pull handles on drawer front, height of drawer unit 450 mm
- 2 drawers with a front height of 100 mm, inside dimensions 875 x 425 x 70 mm
- 1 drawer with a front height of 200 mm, inside dimensions 875 x 425 x 170 mm
- Without central locking

For a shelving depth of <i>mm</i>	Height <i>mm</i>	Ref. no.
524	450	10-15116



### Drawer blocks with 7 drawers

- Supplied with 7 steel sheet drawers with full width pull handle on drawer front, height of drawer unit 1050 mm
- 3 drawers with a front height of 100 mm, inside dimensions 875 x 425 x 70 mm
- 2 drawers with a front height of 150 mm, inside dimensions 875 x 425 x 120 mm
- 2 drawers with a front height of 200 mm, inside dimensions 875 x 425 x 170 mm
- Without central locking

For a shelving depth of <i>mm</i>	Height <i>mm</i>	Ref. no.
524	1050	10-15516

## Trough inserts

- Supplied with 6 troughs, width 145 mm and 12 adjustable dividers

Trough height mm	Description	Surface finish	Ref. no.
50	front height 100 mm	galvanised	10-15526
100	front height 150 mm	galvanised	10-15525
150	front height 200 mm	galvanised	10-15524



## Locking options

- Set consisting of 1 shelf (load capacity 100 kg), 1 cylinder lock with 2 keys operating the top and bottom bolt of the espagnolette lock

Description	Ref. no.
for individual drawers	10-15523
Central locking mechanism for drawer block supplied with 3 individual drawers	10-15117
Central locking mechanism for drawer block supplied with 7 individual drawers	10-15527





## Stainless steel shelving

components from top quality V2A stainless steel

For all environments where hygiene is a must!

- **Shelf load: 200 kg**
- **Bay load: 1200 kg**
- **Sturdy, hygienic and easy to clean: ideal for use in the food industry and the health sector**
- **Assembly without beams, with cross bracing**
- **All components made from high quality stainless steel V2A (material 4301)**
- **Resistant to heat, cold and many chemicals**
- **Also available with shelves with ventilation slots**
- **Fast and easy assembly without bolts saves time**
- **Extensions possible at any time**
- **Shelf levels adjustable in 25 mm increments**
- **All loads indicated refer to uniformly distributed loads**



SHELVING

Shelving height <i>mm</i>	Number of shelves	Features	External bay depth <i>mm</i>	Shelving type	Starter bay	Extension bay			
				Shelf width <i>mm</i>	Ref. no.	Ref. no.			
1750	4	slotted shelves	300	1000 mm	49-52900	49-52915			
			400	1000 mm	49-52901	49-52916			
			500	1000 mm	49-52902	49-52917			
			600	1000 mm	49-52903	49-52918			
			800	1000 mm	49-52904	49-52919			
		solid shelves	300	1000 mm	49-52870	49-52885			
			400	1000 mm	49-52871	49-52886			
			500	1000 mm	49-52872	49-52887			
			600	1000 mm	49-52873	49-52888			
			800	1000 mm	49-52874	49-52889			
			2000	5	slotted shelves	300	1000 mm	49-52905	49-52920
						400	1000 mm	49-52906	49-52921
						500	1000 mm	49-52907	49-52922
						600	1000 mm	49-52908	49-52923
800	1000 mm	49-52909				49-52924			
solid shelves	300	1000 mm			49-52875	49-52890			
	400	1000 mm			49-52876	49-52891			
	500	1000 mm			49-52877	49-52892			
	600	1000 mm			49-52878	49-52893			
	800	1000 mm			49-52879	49-52894			
2500	6	slotted shelves	300	1000 mm	49-52910	49-52925			
			400	1000 mm	49-52911	49-52926			
			500	1000 mm	49-52912	49-52927			
			600	1000 mm	49-52913	49-52928			
			800	1000 mm	49-52914	49-52929			
		solid shelves	300	1000 mm	49-52880	49-52895			
			400	1000 mm	49-52881	49-52896			
			500	1000 mm	49-52882	49-52897			
			600	1000 mm	49-52883	49-52898			
			800	1000 mm	49-52884	49-52899			



## Accessories



**A** Additional shelves



**B** Wall fixing brackets

Pos.	Description		For a shelf length of	For a shelving depth of	Load capacity	Ref. no.
			mm	mm	kg	
<b>A</b>	Shelves	vented shelves	1000	300	150	49-52935
		closed shelves	1000	300	200	49-52930
		vented shelves	1000	400	150	49-52936
		closed shelves	1000	400	200	49-52931
		vented shelves	1000	500	150	49-52937
		closed shelves	1000	500	200	49-52932
		vented shelves	1000	600	150	49-52938
		closed shelves	1000	600	200	49-52933
		vented shelves	1000	800	150	49-52939
		closed shelves	1000	800	200	49-52934
<b>B</b>	Wall fixing brackets	used to fix shelving units to the wall, spacing can be adjusted without increments up to 200 mm, delivery includes fixing material	-	-	-	49-52940



### Wide span racking

### Wide spans for a wide range of items!

Are you handling goods with an awkward shape or heavier items that do not fit into standard shelving? We have a solution to meet your needs: BITO wide span racking is the perfect option from our bolt-free shelving & racking range for an amazingly wide spectrum of storage goods. To widen your storage options, our range now includes 1100 mm deep levels with a maximum load capacity of 700 kg. Various level decking options cater for all requirements.

**Please note:** This racking system has been designed for in-door use only. The indicated load capacities are not valid for earthquake hazard zones. If your storage and order picking facility is intended for use in a seismic hazard zone, please inform BITO in advance!

**i BITO info**

All shelving and racking components fully comply with the latest health and safety regulations.

**Please note:** Wide span racking is not designed for fork lift truck servicing



WIDE SPAN RACKING

## The racking system of your choice for bulky and large items

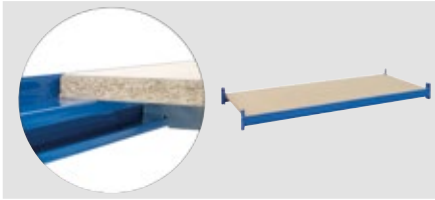

### High grade chipboard decking

- Low cost option
- Max. load per level 550 kg
- 22 mm chipboard panel, quality V20E1
- Complete with galvanised support bars
- Chipboard panels sit flush with the upper edge of the stepped beams to protect panel edges from damage

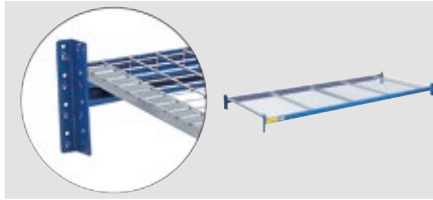

### High grade mesh decking

- Allows instant product identification for order pickers and lets light and water through
- Max. load per level 550 kg
- Galvanised wire-mesh segments sized 50 x 50 mm
- Complete with galvanised support bars

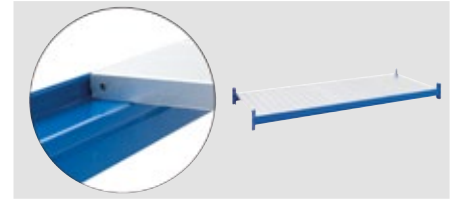

### High grade steel panel decking

- Top quality
- Max. load per level 700 kg
- Steel panels are galvanised
- Drop-in steel panels sit flush with the upper edge of the stepped beams to protect panel edges from damage

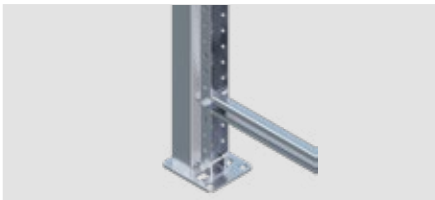

### Frames accept high loads - max. bay load capacity 6200 kg

- Galvanised frames
- Galvanised base plates
- Upright width 60 mm
- Supplied unassembled, can be supplied assembled upon request



### Beams: easy assembly - sturdy connection

- Height adjustable in 50 mm increments
- Epoxy-coated in gentian blue RAL 5010



### Vast range of accessories for unsurpassed adaptability!

- Column guards and upright protectors prevent uprights from getting damaged due to negligent fork lift truck manoeuvring
- Wire-mesh back and side cladding keeps items from falling on aisles and walkways
- Dividers for steel panel decking allow fast subdivision of shelving levels
- Uprights are firmly anchored to the floor with anchor bolts

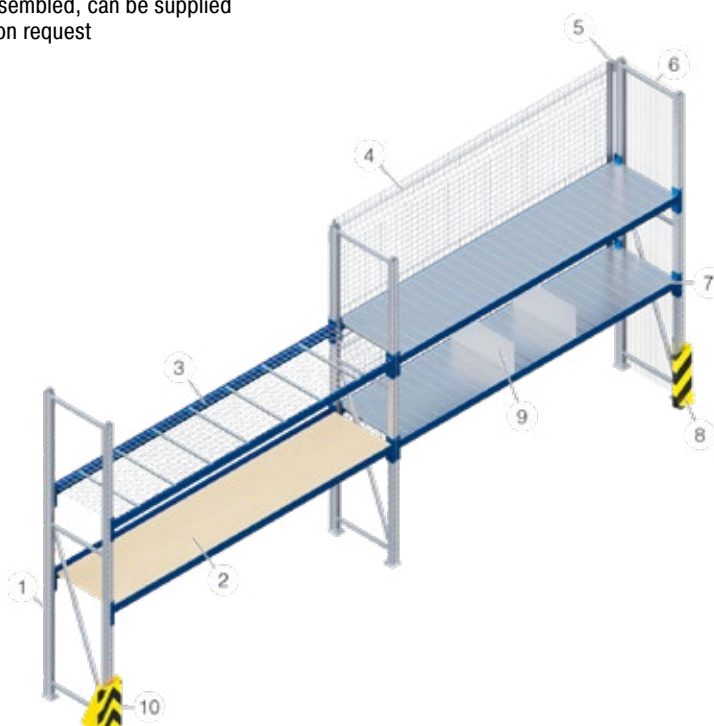

- 1 Frame
- 2 Chipboard shelf
- 3 Wire-mesh decking
- 4 Wire-mesh back cladding
- 5 Bracket for back cladding
- 6 Wire-mesh side cladding
- 7 Steel panel decking
- 8 Column guard L-shaped
- 9 Dividers for steel panel decking
- 10 Column guard U-shaped

## Wide span racking

with chipboard decking

Ideal for storing and picking unpalletised goods.  
Top quality at an excellent price!

- **Shelf load: max. 550 kg**
- **Bay load: max. 3900 kg**
- **Beams are epoxy-coated in gentian blue RAL 5010**
- **Chipboard panels are 22 mm thick, quality V20 E1**
- **Frames are supplied unassembled, galvanised finish**
- **UDL assumed for all load capacities**



**TOP SELLER**

19-44225

**Set offer including 1 starter bay and 1 extension bay with 3 shelf levels**

H x W x D: 2000 x 5580 x 600 mm  
Ref. no. 19-44225

WIDE SPAN RACKING



Width of starter bay  
1470 mm  
1920 mm  
2320 mm  
2820 mm



Width of extension bay  
1410 mm  
1860 mm  
2260 mm  
2760 mm



More frames, level decking options and accessories from page 190

### **i** BITO info

#### **Assembly service**

For your convenience, each delivery comes with instructions for assembly and use for quick and easy installation. All assembly steps and directions of use are illustrated in detail. Upon request we are pleased to submit an offer for on-site installation by our experienced assembly teams.

**Please note:** Wide span racking is not designed for fork lift truck servicing

Shelving height	Bay width	External bay depth	Number of levels	Shelf load	Shelving type	Starter bay	Extension bay
					Bay load	Ref. no.	Ref. no.
mm	mm	mm		kg	kg		
2000	1350	600	3	400	1200	19-25749	19-25751
		800	3	400	1200	19-25757	19-25759
		1100	3	400	1200	19-25765	19-25767
	1800	600	3	500	1500	19-44219	19-44222
		800	3	500	1500	19-44220	19-44223
		1100	3	500	1500	19-44221	19-44224
	2200	600	3	550	1650	19-44201	19-44204
		800	3	550	1650	19-44202	19-44205
		1100	3	550	1650	19-44203	19-44206
	2700	600	3	500	1500	19-25753	19-25755
		800	3	500	1500	19-25761	19-25763
		1100	3	500	1500	19-25769	19-25771
2500	1350	600	4	400	1600	19-25773	19-25775
		800	4	400	1600	19-25781	19-25783
		1100	4	400	1600	19-25789	19-25791
	1800	600	4	550	2200	19-44213	19-44216
		800	4	550	2200	19-44214	19-44217
		1100	4	550	2200	19-44215	19-44218
	2200	600	4	550	2200	19-44207	19-44210
		800	4	550	2200	19-44208	19-44211
		1100	4	550	2200	19-44209	19-44212
	2700	600	4	500	2000	19-25777	19-25779
		800	4	500	2000	19-25785	19-25787
		1100	4	500	2000	19-25793	19-25795

## Wide span racking with drop-in steel panel decking

Ideal for storing and picking unpalletised goods.  
High quality level decking!

- Shelf load: max. 700 kg
- Bay load: max. 6200 kg
- Beams are epoxy-coated in gentian blue RAL 5010
- Flat surfaced, galvanised steel panels allow convenient and effortless order picking
- Frames are supplied unassembled, galvanised finish
- UDL assumed for all load capacities



**TOP SELLER**  
19-44200

**Set offer including 1 starter bay and 1 extension bay supplied with 3 shelf levels each**  
H x W x D: 2000 x 5580 x 600 mm  
Ref. no. 19-44200



Width of starter bay  
1470 mm  
1920 mm  
2320 mm  
2820 mm

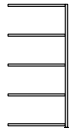

Width of extension bay  
1410 mm  
1860 mm  
2260 mm  
2760 mm



More frames, level decking options and accessories from page 190

### **i** BITO info

#### Assembly service

For your convenience, each delivery comes with instructions for assembly and use for quick and easy installation. All assembly steps and directions of use are illustrated in detail. Upon request we are pleased to submit an offer for on-site installation by our experienced assembly teams.

**Please note:** Wide span racking is not designed for fork lift truck servicing

Shelving height	Bay width	External bay depth	Number of levels	Shelf load	Shelving type	Starter bay	Extension bay
					Bay load	Ref. no.	Ref. no.
mm	mm	mm		kg	kg		
2000	1350	600	3	400	1200	19-25797	19-25799
		800	3	400	1200	19-25813	19-25815
		1100	3	400	1200	19-25829	19-25831
	1800	600	3	500	1500	19-25801	19-25803
		800	3	500	1500	19-25817	19-25819
		1100	3	500	1500	19-25833	19-25835
	2200	600	3	550	1650	19-25805	19-25807
		800	3	550	1650	19-25821	19-25823
		1100	3	550	1650	19-25837	19-25839
	2700	600	3	700	2100	19-25809	19-25811
		800	3	700	2100	19-25825	19-25827
		1100	3	700	2100	19-25841	19-25843
2500	1350	600	4	400	1600	19-25845	19-25847
		800	4	400	1600	19-25861	19-25863
		1100	4	400	1600	19-25877	19-25879
	1800	600	4	500	2000	19-25849	19-25851
		800	4	500	2000	19-25865	19-25867
		1100	4	500	2000	19-25881	19-25883
	2200	600	4	550	2200	19-25853	19-25855
		800	4	550	2200	19-25869	19-25871
		1100	4	550	2200	19-25885	19-25887
	2700	600	4	700	2800	19-25857	19-25859
		800	4	700	2800	19-25873	19-25875
		1100	4	700	2800	19-25889	19-25891





## Frames

WIDE SPAN RACKING

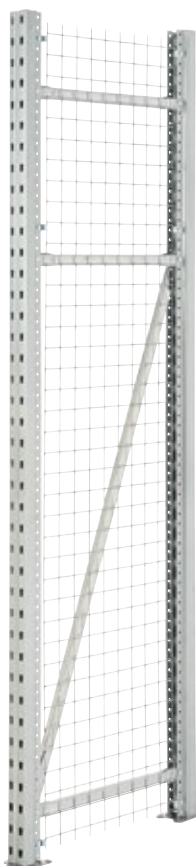

### Frames for wide span racking, unassembled

- Available in a variety of height, depth and load capacity options to suit any application
- Frames consist of uprights, horizontal and diagonal struts, bolt-together assembly
- Robust base plates, bolt-on fitting to uprights to make a very solid connection
- Base plates come pre-drilled for optional floor anchoring
- All components galvanised

	for a shelving depth of	600 mm	800 mm	1100 mm
Height <i>mm</i>	Upright type	Ref. no.	Ref. no.	Ref. no.
2000	F2	19-25287	19-25290	19-25293
	F3	19-25296	19-25300	19-25304
2500	F2	19-25288	19-25291	19-25294
	F3	19-25297	19-25301	19-25305
3000	F2	19-25289	19-25292	19-25295
	F3	19-25298	19-25302	19-25306
3500		19-25299	19-25303	19-25307

### Frames for wide span racking, assembled

	for a shelving depth of	600 mm	800 mm	1100 mm
Height <i>mm</i>	Upright type	Ref. no.	Ref. no.	Ref. no.
2000	F2	19-25267	19-25270	19-25273
	F3	19-25276	19-25279	19-25283
2500	F2	19-25268	19-25271	19-25274
	F3	19-25277	19-25280	19-25284
3000	F2	19-25269	19-25272	19-25275
	F3	19-25278	19-25281	19-25285
3500		19-25308	19-25282	19-25286

Level spacing (FA) <i>mm</i>	Bay load $Q_{max}$	
	Upright type F2 <i>kg</i>	Upright type F3 <i>kg</i>
400	3900	6200
600	2975	5500
800	2050	4800
1000	1775	3900
1200	1500	3000
1400	1225	2675
1600	950	2350

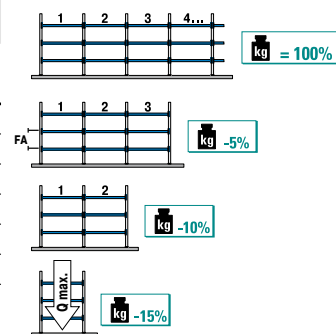

### Wire-mesh side cladding for frames

- Keeps items from falling down sideways
- Grid infill 50 x 50 mm
- Galvanised

for a shelving depth of	600 mm	800 mm	1100 mm
Height <i>mm</i>	Ref. no.	Ref. no.	Ref. no.
2000	19-47963	19-47964	19-47965
2500	19-47966	19-47967	19-47968
3000	19-47969	19-47970	19-47971

## Complete levels

Perfect for order picking

- Complete levels with a load capacity of 400 to 700 kg to suit many storage applications
- Delivery includes stepped beams type WT
- The robust step of the beam covers the edges of the insertable level decking segments and protects them from potential damage during pallet infeeding and outfeeding

### With chipboard decking

- Unbeatable price-performance ratio
- Chipboard panels are 22 mm thick, quality V20 E1

	for a shelving depth of	600 mm	800 mm	1100 mm
Bay width	Load capacity	Ref. no.	Ref. no.	Ref. no.
mm	kg			
1350	400 kg	19-25617	19-25619	19-25615
1800	500 kg	19-13098	19-13106	19-13114
2200	550 kg	19-13100	19-13108	19-13116
2700	500 kg	19-13102	19-13110	19-13118



### With drop-in steel panel decking

- Safe storage of heavy loads of up to 700 kg per level
- Flat surfaced, galvanised steel panels allow convenient and effortless order picking

	for a shelving depth of	600 mm	800 mm	1100 mm
Bay width	Load capacity	Ref. no.	Ref. no.	Ref. no.
mm	kg			
1350	400 kg	19-25611	19-25613	19-25609
1800	500 kg	19-17636	19-17637	19-17638
2200	550 kg	19-17639	19-17640	19-17641
2700	700 kg	19-17642	19-17643	19-17644

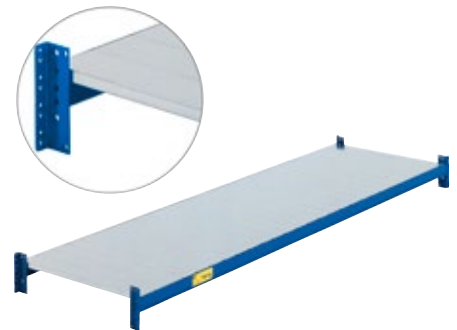

### With wire shelf levels

- Ideal for order picking (lets light and water through)
- Drop-in mesh deck, mesh width 50 x 50 mm, galvanised
- Easy picking even in poor light conditions

	for a shelving depth of	600 mm	800 mm	1100 mm
Bay width	Load capacity	Ref. no.	Ref. no.	Ref. no.
mm	kg			
1350	400 kg	19-28785	19-28795	19-28805
1800	500 kg	19-28787	19-28797	19-28807
2200	550 kg	19-28789	19-28799	19-28809
2700	500 kg	19-28791	19-28801	19-28811
	700 kg	19-28793	19-28803	19-28813



### Complete levels

#### Accessories



A Column guards



B Wire-mesh back cladding



C Bracket for back cladding



D Anchor bolts



E Shims

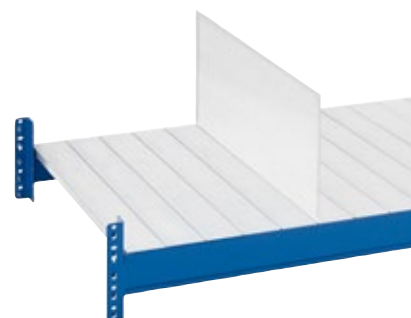

F Cross dividers

Pos.	Description		Dimensions	Pcs/ pack	Ref. no.	
			mm			
A	Column guards	compliant with the latest health and safety regulations stipulating that column guards must be fitted at the ends of each racking row, epoxy-coated in signal yellow, RAL 1003, yellow/black signal striping compliant to DIN 4844, for 2-sided and for 3-sided protection, reliable protection of shelving and racking as well as service vehicles, clearly reduced damage to uprights and columns, therefore fewer idle times and lower costs, increased operator safety	L-shaped for 2-sided protection	L 165 x W 165 x H 400	1	66-4585
			U-shaped for 3-sided protection	L 227 x W 164 x H 400	1	66-29123
B	Wire-mesh back cladding	protects traffic ways and work areas against falling items, traffic ways and work areas located behind single racking rows must be secured against falling items in compliance with the latest safety regulations, from galvanised steel, mesh width 50 x 100 mm, in beaded areas reduced mesh width of 50 x 50 mm, 3.0 mm gridbars, <b>Please note:</b> brackets are not included in the price! Cladding segments are fixed with 4 brackets, for every other segment added, only 2 brackets are required		W 1350 x H 1000	1	66-27793
				W 1350 x H 1500	1	66-27799
				W 1800 x H 1000	1	66-27794
				W 1800 x H 1500	1	66-27800
				W 2200 x H 1000	1	66-27795
				W 2200 x H 1500	1	66-27801
				W 2700 x H 1000	1	66-27796
	W 2700 x H 1500	1	66-27802			
C	Bracket for back cladding	galvanised, for mounting wire-mesh back cladding, including fixings	left-hand side	-	1	19-27200
			right-hand side	-	1	19-27201
D	Anchor bolts	∅ 10 mm, steel grade 10/20, 2 floor anchors required per frame	M10-20 galvanised (pack of 10 pcs.)	L 20	10	66-3408
E	Shims	1 mm thick, galvanised, to compensate floor unevenness	for wide span racking	L 103 x W 80	20	19-26451
F	Cross dividers	galvanised, easy to assemble, including fixings	for steel panels	H 250 x D 600D 600	1	19-18926
				H 250 x D 800D 800	1	19-18927
				H 250 x D 1100D 1100	1	19-18928

## European size stacking containers XL

### standard version

Our all-rounder for a broad range of applications

- Large volume
- From hardwearing polypropylene
- Extremely strong



**TOP SELLER!**  
43-18498



External dimensions L x W	Height	Internal dimensions L x W x H	Volume	Load capacity	Stacking load	Bin type	Colour	Ref. no.
<i>mm</i>	<i>mm</i>	<i>mm</i>	<i>litres</i>	<i>kg</i>	<i>kg</i>			
600 x 400	320	568 x 368 x 316	62	20	300	XL64321		43-18498

## European size stacking containers XL

### with ready-mounted runners and closed sides

Safe, clean and strong – a valuable asset to production logistics in any sector

- Containers are the size of half a Euro pallet
- Load capacity **200 kg**
- 5 height options
- Also available without runners
- Containers with lid and pick opening



**TOP SELLER!**  
43-22585



External dimensions L x W	Height	Internal dimensions L x W x H	Volume	Load capacity	Stacking load	Bin type	Ref. no.
<i>mm</i>	<i>mm</i>	<i>mm</i>	<i>litres</i>	<i>kg</i>	<i>kg</i>		
800 x 600	620	762 x 562 x 501	206	200	800	XL86521DKUFE	43-22585

## Multi-purpose containers MB with double base

### with hinged interlocking lid and fork entry shoes

Our large volume containers 800 x 600 mm are nestable even if fork entry shoes are mounted!

- 3 products in 1 - storage, order picking and transport
- First nestable container with fork entry shoes
- Nest to reduce volume for empty storage and transportation
- Ergonomic molded handgrips for easy handling



**TOP SELLER!**  
6-15319



External dimensions L x W	Height	Volume	Load capacity	Stacking load	Bin type	Ref. no.
<i>mm</i>	<i>mm</i>	<i>litres</i>	<i>kg</i>	<i>kg</i>		
800 x 600	553	147	200	300	MBD86421DKUFE	6-15319

## Hand pallet trucks

Ideal for lifting, moving and positioning heavy or awkward loads

- Designed for in-house transport of palletised loads
- Suited for the professional handling of palletised loads and mesh box pallets in demanding environments
- Turning angle 2 x 105°, tandem load rollers, stair climber rollers at fork tips
- Load capacity 2500 kg!

Load capacity	Width over forks	Fork dim. L x W	Load rollers made from	Swivel castors made from	Ref. no.
<i>kg</i>	<i>mm</i>	<i>mm</i>			
2500	540	1150 x 160	polyurethane	solid rubber	22-21229



**TOP SELLER!**  
22-21229



WIDE SPAN RACKING





## PRO Pallet racking

### We know how to handle pallets!

BITO PRO pallet racking is manufactured in Meisenheim with state-of-the-art production methods and in accordance with the most demanding industry standards. Utmost precision in profile bending and durable epoxy coating are only some features of our products. Another benefit is our wide range of practical accessories to suit any storage requirement.

Benefit from manufacturer competence: our professional sales teams know the trade and ensure that your storage solution has the perfect fit. Our components are galvanised or epoxy-coated for high corrosion resistance.

**Please note:** This racking system has been designed for in-door use only. The indicated load capacities are not valid for earthquake hazard zones. If your storage and order picking facility is intended for use in a seismic hazard zone, please inform BITO in advance!

Are you planning to install your racking system on magnesite flooring or on flooring that must comply with the German Water Resources Act (WHG)/your local laws? This is no problem for us - please contact us.



PALLET RACKING

**i** All shelving and racking components fully comply with the latest German and international health and safety regulations (EN 15512 / DGUV 108-007).

**BITO pallet racking is manufactured to RAL-RG 614/2 standards.** This quality mark confirms that all our products are of superior quality.

**DIN EN ISO 9001 certificate**  
The manufacturing process as well as the entire organisational structure at BITO comply with **DIN EN ISO 9001** requirements.







## We know how to handle pallets!

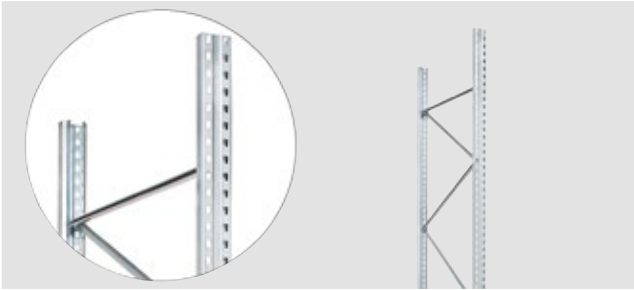

### Sturdy frames for extremely high loads

- Made from top quality strip steel
- Supplied unassembled, can also be supplied fully assembled
- Galvanised
- Level spacing adjustable in 50 mm increments
- Including fixing material and shims

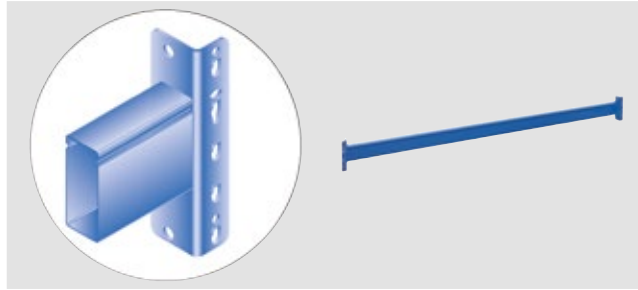

### Beams from one-of-a-kind BITO-Twintop® profiles

- Provide excellent lengthwise rigidity to racking construction
- Innovative profile geometry
- Beams can be adjusted in height on a 50 mm pitch, thus allowing optimum adaptation to loading heights
- Scratch resistant epoxy coating
- Each hook connector has 5 hooks

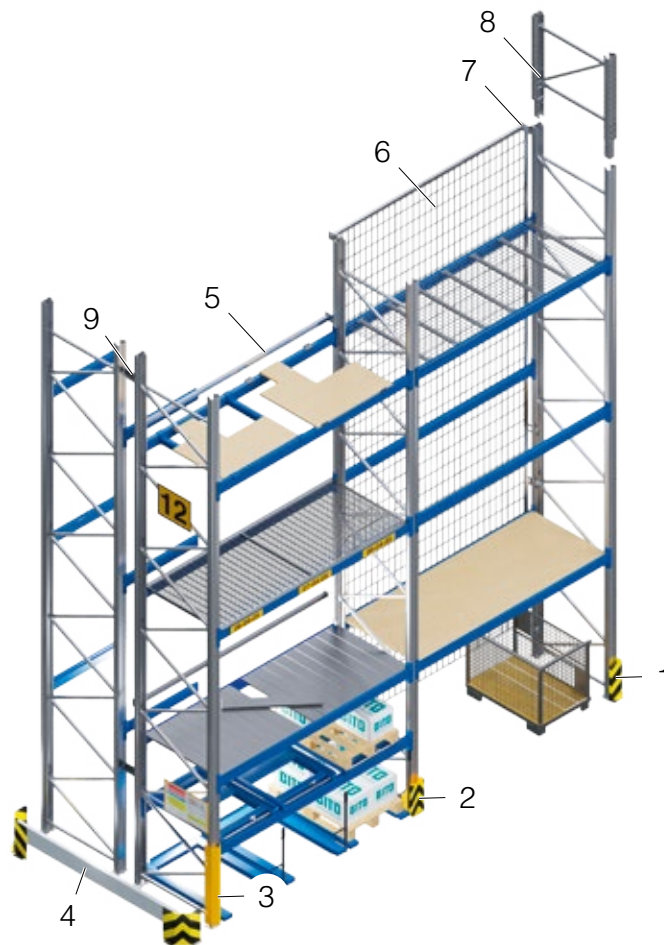

### Broad range of accessories and safety equipment for any storage application

- |                         |                 |   |
|-------------------------|-----------------|---|
| ① Column guard L-shaped | ④ Fencing       | ⑦ Bracket for back stop and back cladding |
| ② Column guard U-shaped | ⑤ Back stop     | ⑧ Frame extension                         |
| ③ Upright protector     | ⑥ Back cladding | ⑨ Spacer for back-to-back rows            |

## Pallet racking - complete units for Euro pallets - short side handled

pallet weight 600 kg, bay width 2700 mm

Attractive price-performance ratio

- Suited for Euro pallets handled short side facing
- Beams are epoxy-coated in gentian blue, RAL 5010
- Level spacing adjustable in 50 mm increments
- Including fixing material and 4 anchor anchor bolts per frame for floor anchoring
- Frames are supplied unassembled
- UDL assumed for all load capacities

**TOP SELLER!**

66-42134



### Assembly service

For your convenience, each delivery comes with instructions for assembly and use for quick and easy installation. All assembly steps and directions of use are illustrated in detail. Upon request we are pleased to submit an offer for on-site installation by our experienced assembly teams.

Racking width approx.	Shelving height <i>mm</i>	External bay depth <i>mm</i>	Loading direction	Number of bays	Number of beam levels	Load per level <i>kg</i>	Bay load <i>kg</i>	Upright type	Maximum level spacing <i>mm</i>	Total capacity in Euro pallets	Ref. no.
5670	2500	1100	short side facing	2	2	1800	3600	P1	2000	18	66-42134
	3000	1100	short side facing	2	2	1800	3600	P1	2200	18	66-42143
	3500	1100	short side facing	2	2	1800	3600	P1	2200	18	66-42152
	4000	1100	short side facing	2	2	1800	3600	P1	2500	18	66-42161
	4000	1100	short side facing	2	3	1800	5400	P1	1500	24	66-42170
	4500	1100	short side facing	2	2	1800	3600	P1	2200	18	66-42179
	4500	1100	short side facing	2	3	1800	5400	P1	1500	24	66-42188
8460	2500	1100	short side facing	3	2	1800	3600	P1	2000	27	66-42135
	3000	1100	short side facing	3	2	1800	3600	P1	2200	27	66-42144
	3500	1100	short side facing	3	2	1800	3600	P1	2200	27	66-42153
	4000	1100	short side facing	3	2	1800	3600	P1	2500	27	66-42162
	4000	1100	short side facing	3	3	1800	5400	P1	1500	36	66-42171
	4500	1100	short side facing	3	2	1800	3600	P1	2200	27	66-42180
	4500	1100	short side facing	3	3	1800	5400	P1	1500	36	66-42189

## Pallet racking - Extension bay, pallet weight 600 kg



For a shelving height of <i>mm</i>	External bay depth <i>mm</i>	Loading direction	Number of beam levels	Upright type	Racking width approx.	1890 mm	2790 mm
					Ref. no.	Ref. no.	
2500	1100	short side facing	2	P1			66-42761
3000	1100	short side facing	2	P1			66-42762
3500	1100	short side facing	2	P1			66-42763
4000	1100	short side facing	2	P1			66-42764
4000	1100	short side facing	3	P1	66-42816		66-42765
4500	1100	short side facing	2	P1			66-42766
4500	1100	short side facing	3	P1	66-42818		66-42767

## Accessories



A Beams



B Column guards

Pos.	Description	Dimensions <i>mm</i>	Beam profile	Ref. no.
A	Beams	BITO TwinTop® profile, type 95L	PT 95L	66-23656
			PT 95L	66-23658
B	Column guards	L 165 x W 165 x H 400	-	66-4585



## Pallet racking - complete units for Euro pallets - short side handled

pallet weight 800 kg, bay width 2700 mm

Benefit from excellent workmanship!

- Suited for Euro pallets handled short side facing
- Beams are epoxy-coated in gentian blue, RAL 5010
- Level spacing adjustable in 50 mm increments
- Including fixing material and 4 anchor anchor bolts per frame for floor anchoring
- Frames are supplied unassembled
- UDL assumed for all load capacities



### i

#### Assembly service

For your convenience, each delivery comes with instructions for assembly and use for quick and easy installation. All assembly steps and directions of use are illustrated in detail. Upon request we are pleased to submit an offer for on-site installation by our experienced assembly teams.

Racking width approx.	Shelving height <i>mm</i>	External bay depth <i>mm</i>	Loading direction	Number of bays	Number of beam levels	Bay load <i>kg</i>	Upright type	Maximum level spacing <i>mm</i>	Total capacity in Euro pallets	Ref. no.
5670	2500	1100	short side facing	2	2	4800	P2	2000	18	66-56402
	3000	1100	short side facing	2	2	4800	P2	2200	18	66-56414
	3500	1100	short side facing	2	2	4800	P2	2200	18	66-56426
	4000	1100	short side facing	2	2	4800	P2	2000	18	66-56440
	4000	1100	short side facing	2	3	7200	P2	1750	24	66-42323
	4500	1100	short side facing	2	2	4800	P2	2000	18	66-56451
	4500	1100	short side facing	2	3	7200	P2	1750	24	66-42341
8460	2500	1100	short side facing	3	2	4800	P2	2000	27	66-56403
	3000	1100	short side facing	3	2	4800	P2	2200	27	66-56415
	3500	1100	short side facing	3	2	4800	P2	2200	27	66-56427
	4000	1100	short side facing	3	2	4800	P2	2000	27	66-56441
	4000	1100	short side facing	3	3	7200	P2	1750	36	66-42324
	4500	1100	short side facing	3	2	4800	P2	2000	27	66-56452
	4500	1100	short side facing	3	3	7200	P2	1750	36	66-42342

## Pallet racking - Extension bay, pallet weight 800 kg

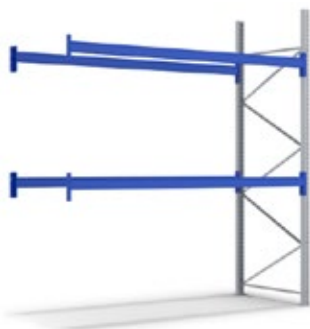

For a shelving height of <i>mm</i>	External bay depth <i>mm</i>	Loading direction	Number of beam levels	Upright type	Racking width approx.	1900 mm	2800 mm
					Ref. no.	Ref. no.	
2500	1100	short side facing	2	P2	66-56400	66-56401	
3000	1100	short side facing	2	P2	66-56412	66-56520	
3500	1100	short side facing	2	P2	66-56423	66-56424	
4000	1100	short side facing	2	P2	66-56436	66-56438	
4000	1100	short side facing	3	P2	66-42833	66-42782	
4500	1100	short side facing	2	P2	66-56449	66-56450	
4500	1100	short side facing	3	P2	66-42835	66-42784	

## Accessories



A Beams



B Column guards

Pos.	Description	Dimensions <i>mm</i>	Beam profile	Ref. no.	
A	Beams	BITO TwinTop® profile, type 95L	L 1800 x H 95	PT 95L	66-23656
		BITO TwinTop® profile, type 110L	L 2700 x H 110	PT 110L	66-23650
B	Column guards	L-shaped for 2-sided protection	L 165 x W 165 x H 400	-	66-4585





## Pallet racking - complete units for Euro pallets - short side handled

pallet weight 1000 kg, bay width 2700 mm

Load capacities per level up to 3000 kg

- Suited for Euro pallets handled short side facing
- Beams are epoxy-coated in gentian blue, RAL 5010
- Level spacing adjustable in 50 mm increments
- Including fixing material and 4 anchor bolts per frame for floor anchoring
- Frames are supplied unassembled
- UDL assumed for all load capacities



**i**  
**Assembly service**  
 For your convenience, each delivery comes with instructions for assembly and use for quick and easy installation. All assembly steps and directions of use are illustrated in detail. Upon request we are pleased to submit an offer for on-site installation by our experienced assembly teams.

Racking width approx.	Shelving height <i>mm</i>	External bay depth <i>mm</i>	Loading direction	Number of bays	Number of beam levels	Load per level <i>kg</i>	Upright type	Maximum level spacing <i>mm</i>	Total capacity in Euro pallets	Ref. no.
5670	2500	1100	short side facing	2	2	3000	P2	2000	18	66-55882
	3000	1100	short side facing	2	2	3000	P2	2000	18	66-55893
	3500	1100	short side facing	2	2	3000	P2	2000	18	66-55904
	4000	1100	short side facing	2	3	3000	P3	1250	24	66-56072
	4000	1100	short side facing	2	2	3000	P2	2000	18	66-55915
	4500	1100	short side facing	2	3	3000	P3	1500	24	66-56083
	4500	1100	short side facing	2	2	3000	P2	2000	18	66-55927
8460	2500	1100	short side facing	3	2	3000	P2	2000	27	66-55883
	3000	1100	short side facing	3	2	3000	P2	2000	27	66-55894
	3500	1100	short side facing	3	2	3000	P2	2000	27	66-55905
	4000	1100	short side facing	3	3	3000	P3	1250	36	66-56073
	4000	1100	short side facing	3	2	3000	P2	2000	27	66-55916
	4500	1100	short side facing	3	3	3000	P3	1500	36	66-56084
	4500	1100	short side facing	3	2	3000	P2	2000	27	66-55926

### Pallet racking - Extension bay, pallet weight 1000 kg



For a shelving height of <i>mm</i>	External bay depth <i>mm</i>	Loading direction	Number of beam levels	Upright type	Racking width approx.	Ref. no.	Ref. no.
					1890 mm	2790 mm	
2500	1100	short side facing	2	P2	66-55880	66-55881	
3000	1100	short side facing	2	P2	66-55891	66-55892	
3500	1100	short side facing	2	P2	66-55902	66-55903	
4000	1100	short side facing	2	P2	66-55913	66-55914	
4000	1100	short side facing	3	P3	66-56070	66-56071	
4500	1100	short side facing	2	P2	66-55924	66-55925	
4500	1100	short side facing	3	P3	66-56081	66-56082	

### Accessories



A Beams



B Column guards

Pos.	Description	Dimensions <i>mm</i>	Beam profile	Ref. no.
A	Beams	BITO TwinTop® profile, type 95L	PT 95L	66-23656
		BITO TwinTop® profile, type 120M	PT 120M	66-23660
B	Column guards	L-shaped for 2-sided protection L 165 x W 165 x H 400	-	66-4585

## Pallet racking- Frames

Suited for beam type	Level spacing (FA) <i>mm</i>	Bay load $Q_{max}$			
		Upright type P1 <i>kg</i>	Upright type P2 <i>kg</i>	Upright type P3 <i>kg</i>	Upright type P4 <i>kg</i>
PT95L	1500	5400	8590	11470	13440
	2000	5400	7200	9080	9600
	2500	3600	5400	5760	7680
PT110L	1500	4700	7310	11570	15660
	2000	4720	7170	9600	12000
	2500	4690	4780	7200	9400
PT120M	1500	6000	8630	11730	15950
	2000	5780	6030	9570	12760
	2500	5200	6030	8940	9570

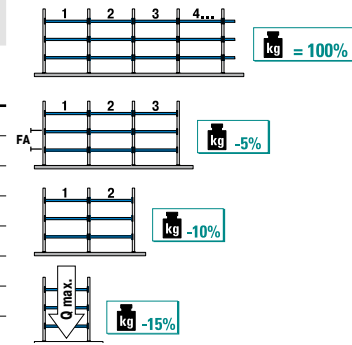

All values refer to a bay width of 2700 mm and racking rows of at least 4 bays. Shorter racking rows have a lower load capacity (cf. drawing on the right); the same applies to 3600 mm wide bays (please ask our team!). The bay load capacity table is only valid for bays with at least 2 beam levels and uniformly distributed shelf loads and bay loads.

### Unassembled

- Made from top quality strip steel
- Level spacing adjustable in 50 mm increments
- Delivery includes 2 uprights with base plate, horizontal and diagonal struts
- 2 anchor bolts per base plate prevent torsion. The anchor bolts and 2 levelling plates with a thickness of 1.5 mm per frame are included in the delivery.
- Frames are supplied 1100 or 800 mm deep to allow long side on or short side on pallet handling

Frame height <i>mm</i>	Frame depth	1100 mm	800 mm
	Upright type	Ref. no.	Ref. no.
2000	P1	66-25216	66-25217
2500	P1	66-25214	66-25215
2500	P2	66-24551	66-24553
3000	P1	66-25212	66-25213
3000	P2	66-25199	66-25200
3500	P1	66-25210	66-25211
3500	P2	66-25197	66-25198
3500	P3	66-26078	66-26077
4000	P1	66-25208	66-25209
4000	P2	66-25195	66-25196
4000	P3	66-25182	66-25183
4500	P1	66-25206	66-25207
4500	P2	66-25193	66-25194
4500	P3	66-25180	66-25181
4500	P4	66-26080	66-26079
5000	P4	66-25165	66-25166

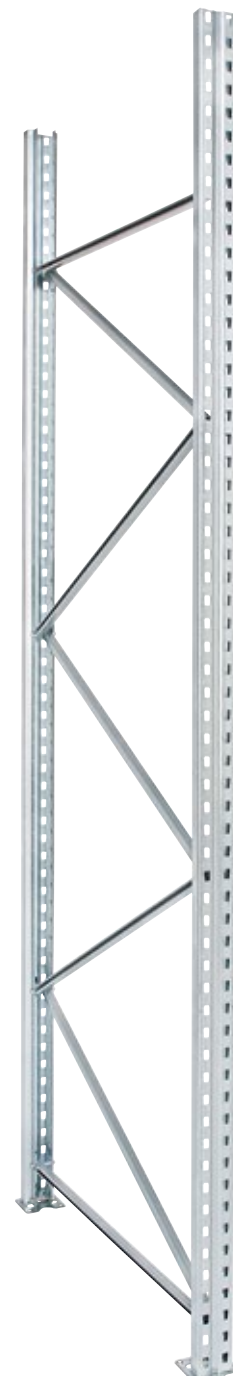

PALLET RACKING



More frame height options on [shop.bitto.com](http://shop.bitto.com) or call us on **0 67 53 122-789**

Are you planning to install your racking system on magnesite flooring or on flooring that must comply with the German Water Resources Act (WHG)/your local laws? This is no problem for us - please contact us.

## Pallet racking- Frames



PALLET RACKING

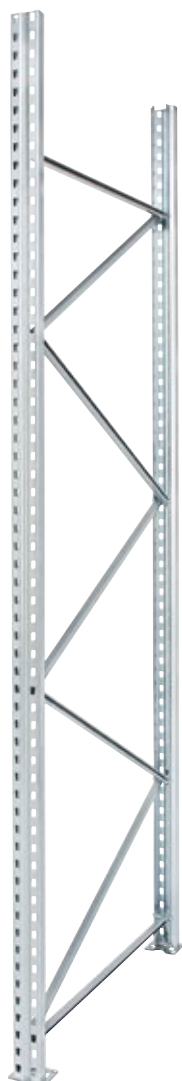

### Assembled

- Our customer service: bolted frames, supplied ready-mounted
- Made from top quality strip steel
- Level spacing adjustable in 50 mm increments
- Delivery includes 2 uprights with base plate, horizontal and diagonal struts
- 2 anchor bolts per base plate prevent torsion. The anchor bolts and 2 levelling plates with a thickness of 1.5 mm per frame are included in the delivery.
- Frames are supplied 1100 or 800 mm deep to allow long side on or short side on pallet handling

Frame height <i>mm</i>	Frame depth	1100 mm	800 mm
	Upright type	Ref. no.	Ref. no.
2000	P1	66-24521	66-24520
2500	P1	66-24523	66-24522
2500	P2	66-24548	66-24552
3000	P1	66-24525	66-24524
3000	P2	66-24539	66-24538
3500	P1	66-24527	66-24526
3500	P2	66-24541	66-24540
3500	P3	66-26074	66-26073
4000	P1	66-24529	66-24528
4000	P2	66-24543	66-24542
4000	P3	66-24557	66-24556
4500	P1	66-24531	66-24530
4500	P2	66-24545	66-24544
4500	P3	66-24559	66-24558
4500	P4	66-26076	66-26075
5000	P4	66-24575	66-24574



More frame height options on [shop.bitto.com](http://shop.bitto.com) or call us on **0 67 53 122-789**

Are you planning to install your racking system on magnesite flooring or on flooring that must comply with the German Water Resources Act (WHG)/your local laws? This is no problem for us - please contact us.

### Accessories



**A** Shims



**B** Anchor bolts



**C** Column guards

Pos.	Description		Upright type	Pcs/pack	Ref. no.	
<b>A</b>	Shims	galvanised, for compensating floor unevenness, are simply placed under the base plates of the frames; easy retro-fitting, shimming is only admissible up to 10 mm max. per base plate, for any floor unevenness exceeding 10 mm it is imperative to use longer anchor bolts	for pallet racking, material thickness 4 mm	P1 - P3	1	66-22830
			for pallet racking, material thickness 1.5 mm (pack of 20 pcs.)	P1 - P3	20	66-27219
<b>B</b>	Anchor bolts	∅ 10 mm, steel grade 10/20, 2 floor anchors required per frame	M10-20 galvanised (pack of 10 pcs.)	-	10	66-3408
<b>C</b>	Column guards		L-shaped for 2-sided protection	P1-P12	1	66-4585

## Beams

### BITO TwinTop® profile

- 5 hooks per connector provide reliable form and force locking
- Gives excellent lengthwise rigidity to racking construction
- Height adjustable on a 50 mm pitch allowing optimum adaptation to the dimensions of stocked loads
- Epoxy-coated in gentian blue, RAL 5010

### BITO TwinTop® profile

Beam length	Load cap. per pair of beams	Beam profile	Ref. no.
<i>mm</i>	<i>kg</i>		
1350	2000	PT 95L	66-24891
1800	2150	PT 95L	66-23656
2200	2150	PT 95L	66-23652
2700	1800	PT 95L	66-23658
	2400	PT 110L	66-23650
	3000	PT 120M	66-23660
	4150	PT 150M	66-28621
3300	2300	PT 120M	66-23654
	3450	PT 150M	66-28623
3600	2400	PT 130M	66-23664
	3200	PT 150M	66-27655
	4450	PT 170S	66-23670

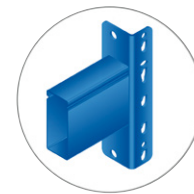

### Accessories



**A** Pallet support bars



**B** Pallet support bars timber topped, unassembled



**C** Support trays

Pos.	Description		For a shelving depth of	Load cap./pce	Ref. no.
			<i>mm</i>	<i>kg</i>	
<b>A</b>	Pallet support bars	efficient pallet support; easy drop-on fitting onto beams, drill bolt-fixing possible to prevent pallet support bars from being pushed sideways, galvanised, 2 required per pallet position	800	640	66-29295
			1100	440	66-29300
<b>B</b>	Pallet support bars, timber topped, unassembled	efficient pallet support; easy drop-on fitting onto beams, designed for safe storage of tools as well as wooden and metal pallets, pallet support bar galvanised, squared timber bars 80 x 80 mm, with 2 drilled holes each to accept round head screws M10 x 100, 2 required per pallet position	800	1350	66-30603
			1100	1090	66-30605
<b>C</b>	Support trays, with back stop, unassembled	suited for PT beams, the support tray prevents containers, wire-mesh box pallets and pallets (whether handled short side or long side facing) from being pushed too far back or dislodged	800	1000	66-28226
			1100	1000	66-28230



## Level decking options to fit BITO-TwinTop® beams



PALLET RACKING



### Chipboard panels with 4 positioning angles each

- Classic drop-on decking option that suits most applications
- Chipboard panels are 38 mm thick, quality V20 E1
- Positioning angles are galvanised
- Supplied with fixing material for bolt-on mounting to BITO TwinTop® beams
- Please order BITO TwinTop® beams separately

External bay depth	1100 mm		800 mm	
Suited for a beam length of	Load cap. per level	Ref. no.	Load cap. per level	Ref. no.
mm	kg		kg	
1350	650	66-8807	1200	66-19377
1800	900	66-8810	1600	66-19378
2200	1100	66-8811	1950	66-19379
2700	1350	66-8812	1650	66-19380
3300	1650	66-8813	1400	66-19381
3600	1800	66-8814	1300	66-19382



### Chipboard panels on support bars

- Support bars provide additional support
- Level decking sits flush with the box-type beams
- Chipboard panels are 38 mm thick, quality V20 E1
- Pallet support bars are epoxy-coated in gentian blue, RAL 5010
- Supplied with support bars
- Please order BITO TwinTop® beams separately

Suited for a beam length of	External bay depth	1100 mm		800 mm		
		Number of support bars	Load cap. per level	Ref. no.	Load cap. per level	Ref. no.
mm			kg		kg	
1350	3		1500	66-29353	1500	66-29347
1800			2200	66-29354	1800	66-29348
2200	4		2100	66-29355	2100	66-29349
2700			3000	66-29356	2200	66-29350
3300	5		3300	66-29357	2800	66-29351
3600			3300	66-29358	2300	66-29352

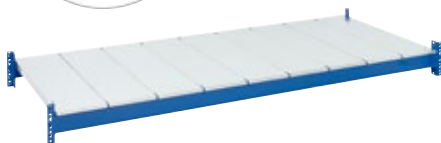

### Drop-on steel panels

- Superior quality steel panels can carry particularly heavy loads
- Cut-outs in the lipped short sides keep the panels flush with the beams
- Level decking consisting of individual steel panels
- Please order BITO TwinTop® beams separately

Suited for a beam length of	External bay depth	1100 mm	800 mm	
		Load cap. per level	Ref. no.	Ref. no.
mm		kg		
1350		1500	66-19005	66-18999
1800		2000	66-19006	66-19000
2200		2200	66-19007	66-19001
2700		3050	66-19008	66-19002
3300		3300	66-19009	66-19003
3600		4000	66-19010	66-19004

## **i** BITO info

**Do not exceed maximum beam load capacities.  
Beams are not included in the price.**

### Grating decks grating decks

- Good air circulation and water permeability
- Ideal for warehouses with a sprinkler system
- Lipped edges allow flush drop-on fitting on beams without adding to the level height
- Grid infill 66 x 33 mm
- Mesh decking accepts high load capacities
- Force-fit connection of grid bars with the angled frame makes mesh decks particularly suited for heavy duty applications
- Easy and fast drop-on fitting onto the box-type beams
- Stocked goods can easily be identified from below
- Please order BITO TwinTop® beams separately

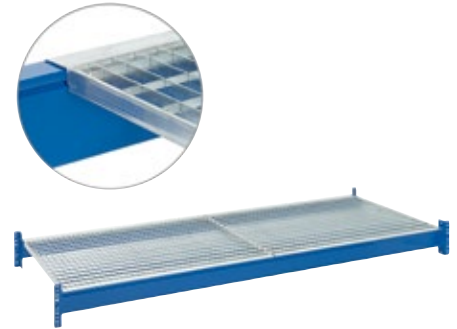

Description	Suited for a beam length of <i>mm</i>	for a shelving depth of		
		Load cap. per level <i>kg</i>	1100 mm Ref. no.	800 mm Ref. no.
1 segment	1350	900	66-40876	
		1500	66-40877	66-40870
	1800	1200	66-40878	
		2000	66-40879	66-40871
2 piece set	2200	2400	66-40880	66-40872
	2700	1800	66-40881	
		3000	66-40882	66-40873
		3600	66-40883	66-40874
	3600	2400	66-40884	
		4000	66-40885	66-40875

### Wire shelf levels

- Budget alternative to mesh decking
- Good air circulation and water permeability
- Comply with fire prevention regulations to protect your warehouse - water permeability exceeds 70%
- Ideal for storing and picking cartons, bins and containers
- No sharp edges that could cause damage to cartons and reduce picking speed
- Easy and fast drop-on fitting onto beams
- Supplied with support bars already welded to the segments
- Please order BITO TwinTop® beams separately



External bay depth <i>mm</i>	Suited for a beam length of <i>mm</i>	Segment dimensions <i>mm</i>	Load cap. per level <i>kg</i>	Ref. no.
800	1350	1325x800	500	66-44412
		1325x800	1000	66-40517
	2700	1325x800	1000	66-44413
		1325x800	2000	66-40518
1100	1350	1325x1100	1000	66-40510
	1800	890x1100	500	66-44414
		890x1100	1500	66-40511
		890x1100	2000	66-40512
	2700	890x1100	750	66-44415
		1325x1100	2000	66-40513
		890x1100	3000	66-40514
		3600	890x1100	1000
	890x1100		3000	66-40515
	890x1100		4000	66-40516

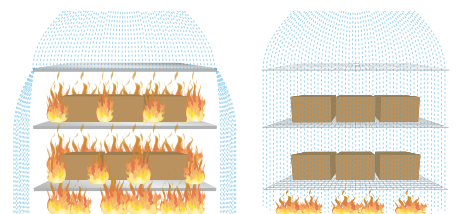

Left: fire propagation with solid steel sheet shelves  
Right: fire propagation with wire-mesh shelves that allow water to pass



## Pull-out units



PALLET RACKING



Everything within easy reach!

### Pull-out units – designed for ergonomic working

- Ideal, strain-free order picking from 3 sides
- For pallets handled long side on and a size of 1200 x 800 mm
- Floor mounted or beam mounted unit
- Supplied with safety locking mechanism for use as beam mounted unit
- Pallets can be pulled out from the racking without effort
- Sturdy steel construction, sealed ball bearings, smooth operation
- Suited for a racking depth of 1100 mm
- Epoxy-coated in gentian blue RAL 5010
- Floor mounted unit supplied with 700 mm handle

Description	Height adjustment range	Pull-out capacity	Load capacity	Ref. no.
	mm		kg	
for use as beam mounted unit	90	70 %	600	34-33200
			800	34-33201
for use as floor mounted unit	80	85 %	800	34-33195
			1000	34-33196



Scan this QR code:

### Product video Extraction Unit

[www.bitto.com/qr-azv-int](http://www.bitto.com/qr-azv-int)

### **i** BITO info

**Please note:**

Pulling out a beam mounted pull-out unit creates an off-centre load, i.e. the front beam will carry the entire admissible load per level.

For this reason, pallet racking with pull-out units require beams with double load capacity and the beams must be bolted to the uprights!

Make sure that you only pull out 1 unit at a time in racking with several pull-out units per level or per bay. Immediately push back the pull-out unit after use and lock it!

Pull-out units for load carriers with other dimensions are available upon request.



Suitable bins from page 54

## Rack end protector set

### Rack end protector set

- Protect short sides of shelving and racking runs and increase operator safety
- Since this barrier encloses both uprights of a frame, no extra column guards are required to protect the ends of a racking row
- Epoxy-coated in signal yellow, RAL 1003, yellow/black signal striping compliant to DIN 4844
- Galvanised steel sheet plank
- Delivery includes fixing material and heavy duty floor anchors
- Compliant with the latest health and safety regulations
- Clearly reduced damage to uprights and columns, therefore fewer idle times and lower costs
- A second steel plank can be added for increased safety



	Rack end protector set	Additional fencing planks
Dimensions L x D x H	Ref. no.	Ref. no.
<i>mm</i>		
1200 x 270 x 400	66-40937	66-40933
2500 x 270 x 400	66-40936	66-40932

### In-line posts for fencing rows

- The in-line post and additional fencing planks allow to extend barrier length as required
- Helps to set up longer fencing rows
- This sturdy barrier system protects warehouse and operating equipment from damage
- Supplied with heavy duty floor anchors

Dimensions L x D x H	Ref. no.
<i>mm</i>	
250 x 201 x 400	66-40924



PALLET RACKING





**Shelving & racking protection**

PALLET RACKING



**Upright protectors**

- Provide protection against collision damage and prevent downtimes
- Epoxy-coating in signal yellow, RAL 1003, provides high visibility
- Bolt-on fixing to upright - no floor fixing to prevent damage to flooring if upright is hit by a vehicle
- Designed to fit BITO pallet racking PRO
- Delivery includes fixing material
- Material steel

Height <i>mm</i>	Width <i>mm</i>	Upright type	Ref. no.
715	80	P1	66-31000
	90	P2	66-31001
	100	P3	66-31002
	120	P4-6	66-31003



Scan this QR code:

**Product video on upright protectors**

[www.bitto.com/qr-stuetzenschutz-int](http://www.bitto.com/qr-stuetzenschutz-int)

→ Frames on page 199



**Column guards**

- Compliant with the latest health and safety regulations stipulating that column guards must be fitted at the ends of each racking row
- Epoxy-coated in signal yellow, RAL 1003, yellow/black signal striping compliant to DIN 4844
- For 2-sided and for 3-sided protection
- Reliable protection of shelving and racking as well as service vehicles
- Clearly reduced damage to uprights and columns, therefore fewer idle times and lower costs
- Increased operator safety

Height <i>mm</i>	Description	Features	Upright type	Ref. no.
400	L-shaped for 2-sided protection	supplied with 4 heavy duty floor anchors Ø 12 mm	P1-P12	66-4585
	U-shaped for 3-sided protection	supplied with 4 chemical floor anchors M12	P1-P3	66-29123
			P4-P12	66-29125

→ More info on our upright types from page 200

# Flexible upright protectors

- Optimum protection for shelving and racking uprights, thereby reducing idle times and costs
- Flexible PVC, resilient, dimensionally stable – material bounces back to original shape
- Impact energy is absorbed at the front and at the sides of the round end posts – no damage to floor
- Certified by the German Inspection Association TÜV to validate product safety
- Available in various dimensions to fit upright types P1 - P6



Protection from side impacts



Protection from front impacts



Tool kit for adjusting flexible buffer profiles



## Flexible upright protectors

- Material plastic
- Colour yellow

Height <i>mm</i>	Upright type	Ref. no.
600	P1	46-45600
	P2	46-45601
	P3	46-45602
	P4-P7	46-45603

## Tool kit for adjusting flexible buffer profiles, for flexible upright protectors

- The flexible buffer profiles can only be mounted with this tool kit. Please add this item to your order.
- Material plastic

	Ref. no.
Tool kit for adjusting flexible buffer profiles for flexible upright protectors	46-45604



**i BITO info**  
 Assembly instructions can be downloaded from [www.bitto.com](http://www.bitto.com)



PALLET RACKING

## Safety equipment



PALLET RACKING



### Solid back stop

- Prevents pallets from being pushed too far in back-to-back racking
- In compliance with safety regulations for back-to-back racking stipulating that a protective back stop must be installed if the distance between pallets stored on either side of a racking level is less than 100 mm
- Solid square-tube sections, 50 mm wide
- Push-in fitting into bracket cut-outs, secured with splint pins
- Including bracket and fixing material
- Mounted to the frames with a distance of 75 mm to ensure easy and optimum centering of Euro pallets handled short side facing

Beam length <i>mm</i>	Ref. no.
1350	66-22888
1800	66-22945
2200	66-22947
2700	66-22949
3300	66-22951
3600	66-22953



### Wire-mesh back cladding

- Protects traffic ways and work areas against falling items
- Traffic ways and work areas located behind single racking rows must be secured against falling items in compliance with the latest safety regulations
- From galvanised steel, mesh width 50 x 100 mm, in beaded areas reduced mesh width of 50 x 50 mm, 3.0 mm gridbars
- **Please note:** brackets are not included in the price! Cladding segments are fixed with 4 brackets, for every other segment added, only 2 brackets are required

Height	1000 mm	1500 mm
Beam length <i>mm</i>	Ref. no.	Ref. no.
1350	66-27793	66-27799
1800	66-27794	66-27800
2200	66-27795	66-27801
2700	66-27796	66-27802
3300	66-27797	66-27803
3600	66-27798	66-27804



### Brackets for back stops and back cladding

- Length x + 70 mm
- Galvanised finish
- Delivery includes fixing material
- Required to fix back stop and/or wire-mesh back cladding

Description	right-hand bracket	left-hand bracket
Length x <i>mm</i>	Ref. no.	Ref. no.
25	66-27160	66-27161
75	66-27162	66-27163
100	66-27164	66-27165



## Frame extension

- In compliance with the latest safety regulations, this 750 mm high bolt-on frame extension prevents items from falling off the top level at the short sides of racking rows
- Galvanised finish
- Delivery includes fixing material

Height of frame extension <i>mm</i>	Frame depth	1100 mm	800 mm
	Upright type	Ref. no.	Ref. no.
750	P1	66-24501	66-24500
	P2	66-24503	66-24502
	P3	66-24505	66-24504
	P4-P6	66-24507	66-24506



## Spacers for back-to-back pallet racking rows

- Galvanised finish
- Delivery includes fixing material
- Required according to EN15635
- 2 spacers per upright - required for uprights facing each other in back-to-back racking

Wall spacing <i>mm</i>	Ref. no.
200	66-20020
250	66-29276
300	66-20076





## Pallet live storage

### Retrofit your static pallet racking with flow levels!

Optimise picking ergonomics and productivity!

**Please note:** This racking system has been designed for in-door use only. The indicated load capacities are not valid for earthquake hazard zones. If your storage and order picking facility is intended for use in a seismic hazard zone, please inform BITO in advance!

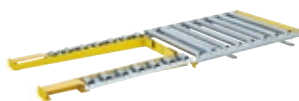

Roller conveyor module, suited for hand pallet truck retrieval



Roller conveyor module, full width rollers



Roller conveyor module, two track option



Roller track module with flanged plastic rollers



ORDER PICKING OF PALLETISED LOADS

## Benefits of retrofitting static pallet racking

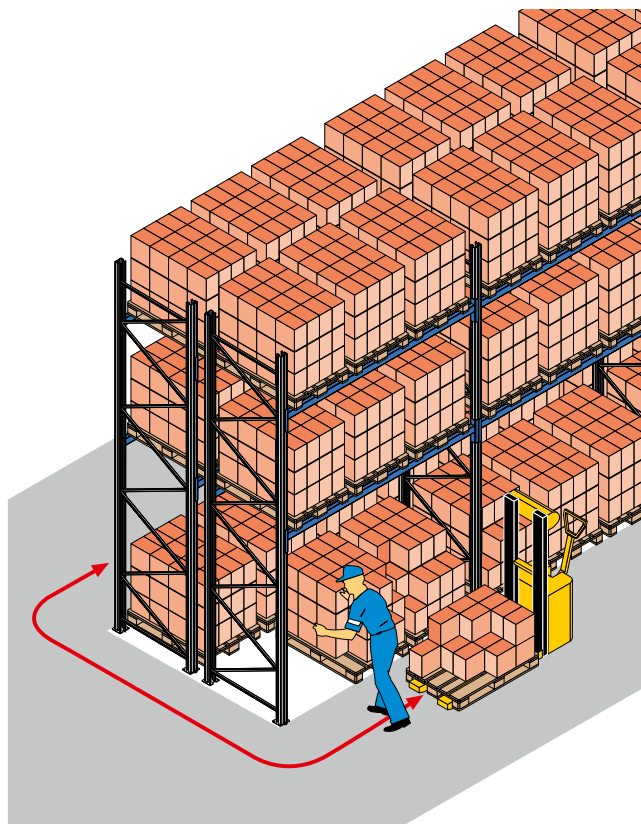

**Before flow level fitting**

**Example:**

**Double deep pallet racking row**

Goods are picked directly off the pallet. In conventional pallet storage installations, items in the back of the floor level can only be picked by bending and stretching.

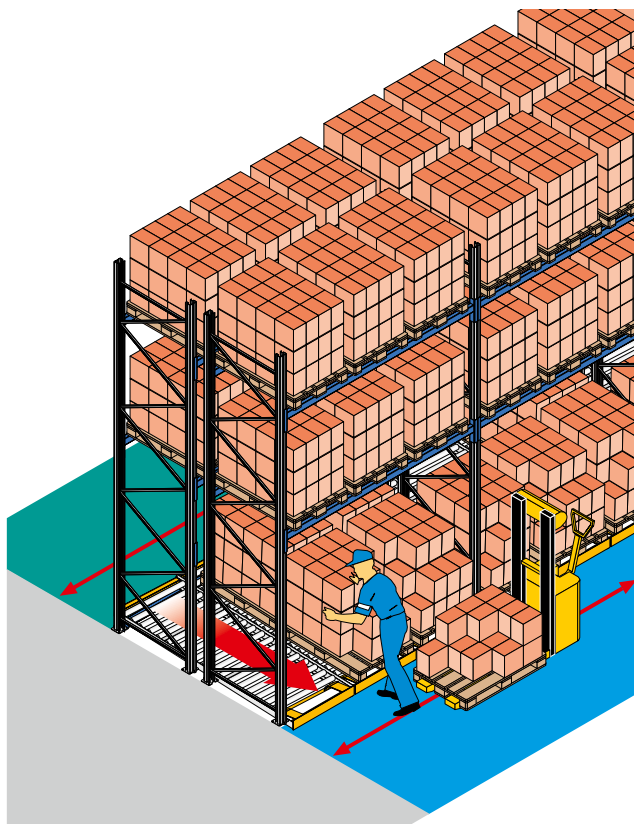

**After flow level fitting**

**Example:**

**Double deep pallet racking row**

The floor level has been fitted with a roller conveyor lane. After a pallet has been retrieved from the lane, the next pallet will move unassisted to the picking face, allowing convenient order picking directly off the pallet.





## Pallet live storage

Retrofit your static pallet racking with flow levels!

### Roller conveyor segments, full width rollers

- Ideal for floor level order picking
- The second pallet will move unassisted to the picking face
- 2700 mm wide bays accommodate 3 roller conveyor lanes for 800 mm wide pallets handled long side on
- 3300 mm wide bays accommodate 3 roller conveyor lanes for 1000 mm wide pallets handled long side on
- Galvanised rollers provide a clean and bright appearance

Suited for a pallet width of <i>mm</i>	Suited for a pallet length of <i>mm</i>	Suited for a pallet weight of <i>kg</i>	Roller pitch T <i>mm</i>	Ref. no.
800	1200	1000	144	37-37807
1000	1200	1000	144	37-37809

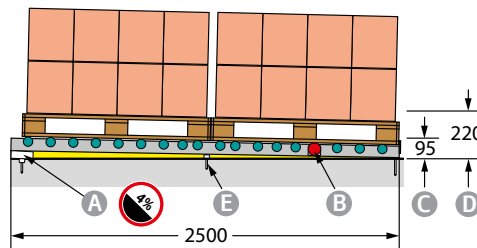
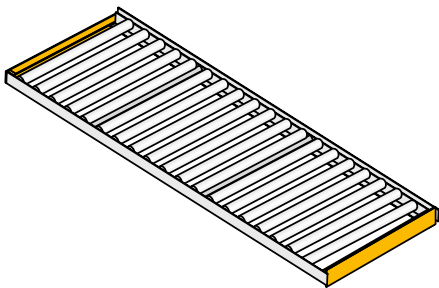

- A Auxiliary incline 4%
- B Braking roller
- C Upper edge of roller track
- D Required lift height
- E Floor anchoring

### Roller conveyor segments suited for hand pallet truck retrieval

- Ideal for loading and retrieving pallets with a hand pallet truck
- The second pallet will move unassisted to the picking face
- 2700 mm wide bays accommodate 3 roller conveyor lanes for 800 mm wide pallets handled long side on
- 3300 mm wide bays accommodate 3 roller conveyor lanes for 1000 mm wide pallets handled long side on
- Solid side frame to protect conveyor rollers and extend useful service life
- Galvanised rollers provide a clean and bright appearance
- Segments are fixed with floor anchors

Suited for a pallet width of <i>mm</i>	Suited for a pallet length of <i>mm</i>	Suited for a pallet weight of <i>kg</i>	Roller pitch T <i>mm</i>	Ref. no.
800	1200	1000	144	37-37811
1000	1200	1000	144	37-37812

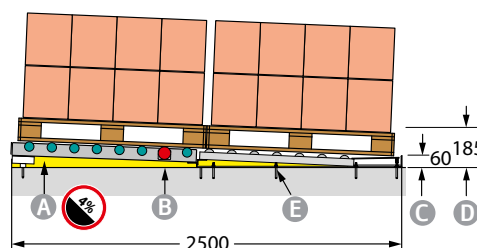
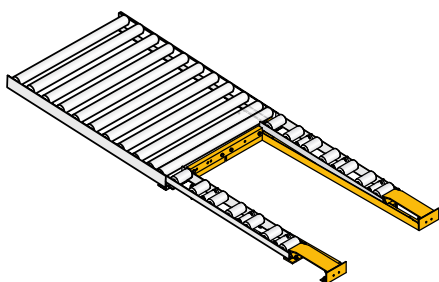

- A Auxiliary incline 4%
- B Braking roller
- C Upper edge of roller track
- D Required lift height
- E Floor anchoring

ORDER PICKING OF PALLETISED LOADS

## Roller conveyor segments, two track option

- Ideal for floor level order picking
- The second pallet will move unassisted to the picking face
- 2700 mm wide bays accommodate 3 roller conveyor lanes for 800 mm wide pallets handled long side on
- 3300 mm wide bays accommodate 3 roller conveyor lanes for 1000 mm wide pallets handled long side on
- Galvanised rollers provide a clean and bright appearance

Suited for a pallet width of	Suited for a pallet length of	Suited for a pallet weight of	Roller length	Roller pitch T	Ref. no.
mm	mm	kg	mm	mm	
800, 1000	1200	1000	124	144	37-37813

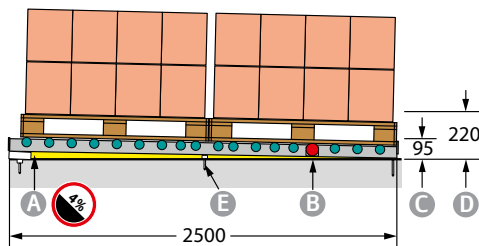

- Ⓐ Auxiliary incline 4%
- Ⓑ Braking roller
- Ⓒ Upper edge of roller track
- Ⓓ Required lift height
- Ⓔ Floor anchoring

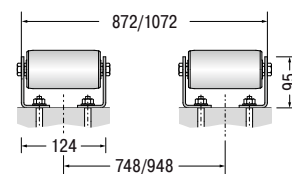
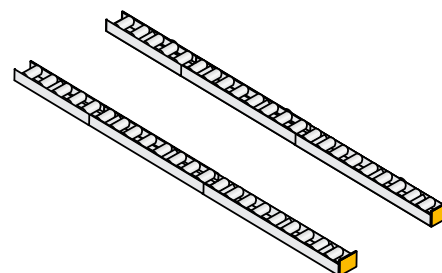

## Floor-mounted roller conveyor segments

- Ideal for moving loads without effort
- Improves manual in-house material transport while reducing health and safety risks for operators
- Suited for loads of up to 1000 kg
- Available with a roller pitch of 48 mm or 96 mm
- Please order roller guards separately
- Anchor bolts ensure secure floor mounting

Description	Length	Roller pitch T	Ref. no.
	mm	mm	
	1248	96	37-20168
	2496	96	37-20169
	1248	48	37-20166
	2496	48	37-20167
			37-10222
			37-10221
			66-22408





### Heavy duty roller tracks

- Available in three options
- Self-locking, hardwearing steel axles
- For heavy-duty applications
- Smooth roller operation
- Made from robust materials for a long service life
- Roller width 62 mm

#### With cylindrical steel rollers

- Roller track profiles galvanised
- Galvanised rollers with ball bearing

		Roller pitch T		96 mm	72 mm	48 mm
Load cap. per roller	Roller Ø	Length	Ref. no.	Ref. no.	Ref. no.	Ref. no.
kg	mm	mm				
130	45 mm	2400	37-20175	37-20174	37-20173	
		3600	37-20172	37-20171	37-20170	

#### With cylindrical plastic rollers

- Roller track profiles galvanised
- Black PVC rollers with glide bearing

		Roller pitch T		96 mm	72 mm	48 mm
Load cap. per roller	Roller Ø	Length	Ref. no.	Ref. no.	Ref. no.	Ref. no.
kg	mm	mm				
65	46 mm	2400	37-14175	37-14176	37-14177	
		3600	37-14190	37-14191	37-14192	

#### With flanged plastic rollers

- Roller track profiles galvanised
- Black PVC rollers with glide bearing

		Roller pitch T		96 mm	72 mm
Load cap. per roller	Roller Ø	Length	Ref. no.	Ref. no.	Ref. no.
kg	mm	mm			
65	46 mm	2400	37-14180	37-14181	
		3600	37-14195	37-14196	

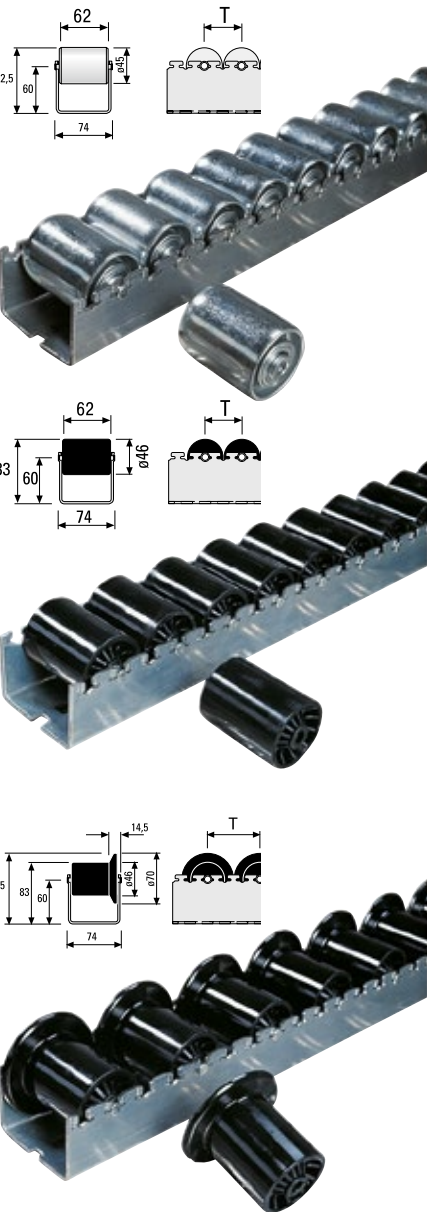

#### Accessories

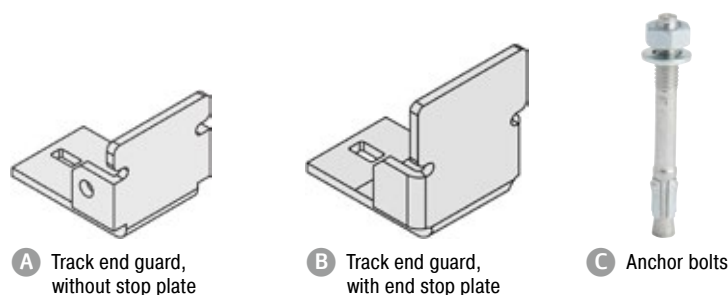

Pos.	Description	Ref. no.
A	Track end guard, without stop plate, delivery includes bolts	37-22813
B	Track end guard, with end stop plate, delivery includes bolts	37-22814
C	Anchor bolts, M10-20 galvanised (pack of 10 pcs.)	66-3408

ORDER PICKING OF PALLETISED LOADS

## Roller tracks

for light weight and medium weight goods

Everything within easy reach!

- Robust plastic rollers
- Robust axles
- Roller track profiles galvanised
- Product sold by meter

### With cylindrical plastic rollers

- White plastic rollers

Roller length	Load cap. per roller	Roller Ø	Roller pitch T	Length	Ref. no.
<i>mm</i>	<i>kg</i>	<i>mm</i>	<i>mm</i>	<i>mm</i>	
24.5	4	26	28	2000	36-8598
				3000	36-8599

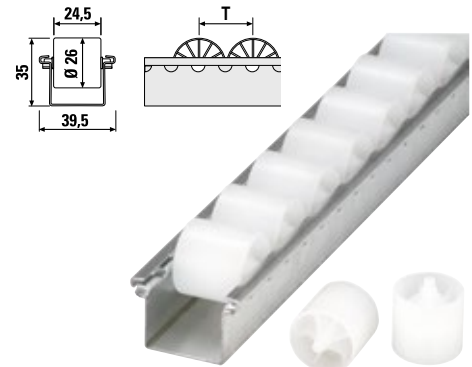

### With cylindrical plastic rollers and steel axle

- Plastic rollers are anthracite grey

Roller length	Load cap. per roller	Roller Ø	Roller pitch T	Length	Ref. no.
<i>mm</i>	<i>kg</i>	<i>mm</i>	<i>mm</i>	<i>mm</i>	
24.5	8	26	28	2000	36-27720
				3000	36-27721

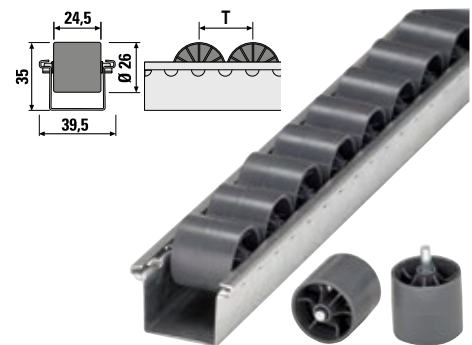

### With cylindrical plastic rollers (ESD version) and steel axles

- Cylindrical rollers from black plastic
- ESD version

Roller length	Load cap. per roller	Roller Ø	Roller pitch T	Length	Ref. no.
<i>mm</i>	<i>kg</i>	<i>mm</i>	<i>mm</i>	<i>mm</i>	
24.5	8	26	28	2000	36-27722
				3000	36-27723

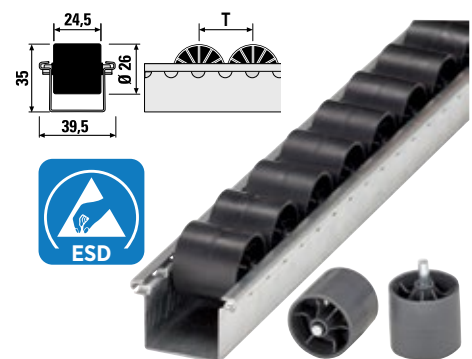

### With flanged plastic rollers

- White plastic rollers

Roller length	Load cap. per roller	Roller Ø	Roller pitch T	Length	Ref. no.
<i>mm</i>	<i>kg</i>	<i>mm</i>	<i>mm</i>	<i>mm</i>	
24.5	4	26	42	2000	36-8622
				3000	36-8623

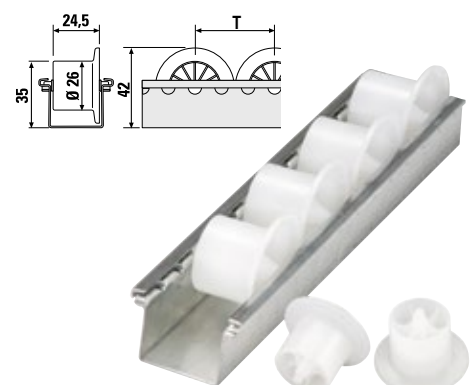

## Carton live storage

### Everything within easy reach!

Efficiency in any modern warehouse and logistics centre is largely determined by the choice of the right order picking system to ensure optimum order throughput. We at BITO offer you expert know-how and long-standing experience in planning and manufacturing customised order picking systems. The following pages present some easy-to-realise solutions for your warehouse.

**Carton live storage** accommodates smaller sized storage units such as plastic bins and containers, cartons or individual items without packaging. All goods are loaded at the rear of a storage installation and move gravity-driven on inclined roller lanes to the picking face where they can be picked to requirement.

Product storage in FIFO (First in - First out) order as well as single reference lines allow easy monitoring of production batches and sell-by dates.

**Please note:** This racking system has been designed for in-door use only. The indicated load capacities are not valid for earthquake hazard zones. If your storage and order picking facility is intended for use in a seismic hazard zone, please inform BITO in advance!







## Smart ideas to boost picking performance

### First in – first out

- **Items stored first are retrieved first**
- Easy monitoring of sell-by dates and production batches
- Ergonomic picking curve
- All reference lines on stock can be viewed immediately
- Stock items are always available at the picking side
- Items move unassisted to the picking face

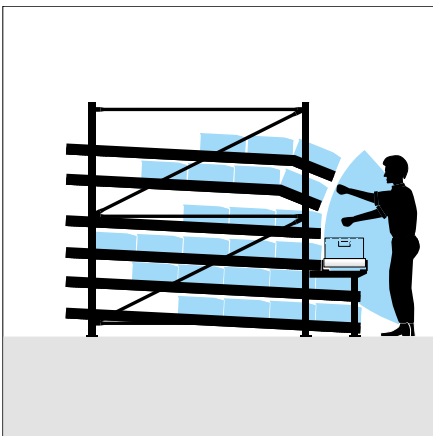

### Very good floor space utilisation

- Substantial gain in floor space **unused floor space is considerably reduced**
- Separate picking and loading aisles – operators do not disturb each other
- Shorter travel routes for order pickers

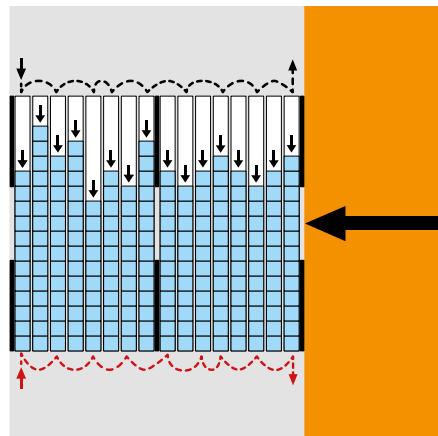

### Substantially reduced travel times

- Reading time (1) – remains the same as with conventional floor space occupation
- Picking time (2) – remains the same as with conventional floor space occupation
- Travel time (3) – **is cut down by as much as two-thirds** – increased turnover frequency

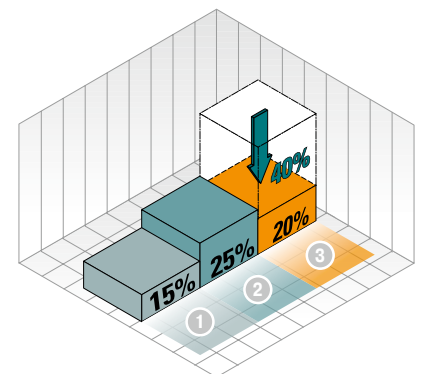



### Roller tracks

for light weight and medium weight goods

Everything within easy reach!

- Robust plastic rollers
- Robust axles
- Roller track profiles galvanised
- Product sold by meter

**i BITO info**

Other lengths upon request

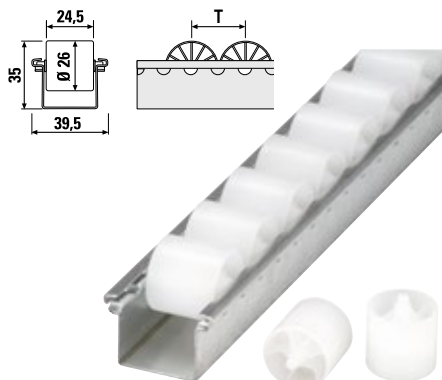

#### With cylindrical plastic rollers

- White plastic rollers

Roller length	Load cap. per roller	Roller Ø	Roller pitch T	Length	Ref. no.
<i>mm</i>	<i>kg</i>	<i>mm</i>	<i>mm</i>	<i>mm</i>	
24.5	4	26	28	2000	36-8598
				3000	36-8599

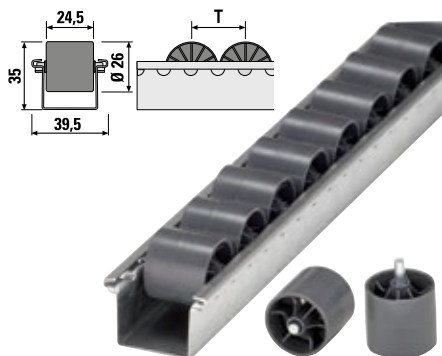

#### With cylindrical plastic rollers and steel axle

- Plastic rollers are anthracite grey

Roller length	Load cap. per roller	Roller Ø	Roller pitch T	Length	Ref. no.
<i>mm</i>	<i>kg</i>	<i>mm</i>	<i>mm</i>	<i>mm</i>	
24.5	8	26	28	2000	36-27720
				3000	36-27721

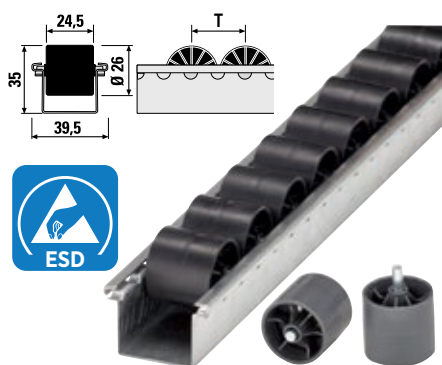

#### With cylindrical plastic rollers (ESD version) and steel axles

- Cylindrical rollers from black plastic
- ESD version

Roller length	Load cap. per roller	Roller Ø	Roller pitch T	Length	Ref. no.
<i>mm</i>	<i>kg</i>	<i>mm</i>	<i>mm</i>	<i>mm</i>	
24.5	8	26	28	2000	36-27722
				3000	36-27723

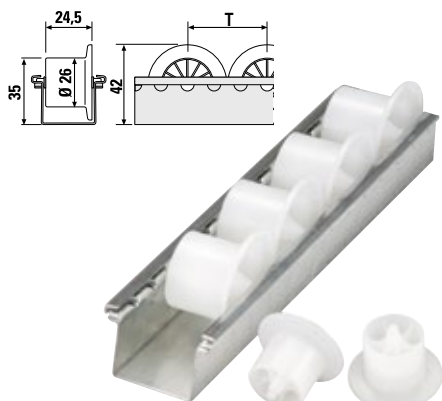

#### With flanged plastic rollers

- White plastic rollers

Roller length	Load cap. per roller	Roller Ø	Roller pitch T	Length	Ref. no.
<i>mm</i>	<i>kg</i>	<i>mm</i>	<i>mm</i>	<i>mm</i>	
24.5	4	26	42	2000	36-8622
				3000	36-8623

## With flanged plastic rollers / ESD version

- Flanged rollers from black plastic
- ESD version

Roller length	Load cap. per roller	Roller Ø	Roller pitch T	Length	Ref. no.
<i>mm</i>	<i>kg</i>	<i>mm</i>	<i>mm</i>	<i>mm</i>	
24.5	4	26	42	2000	36-30658
				3000	36-30659

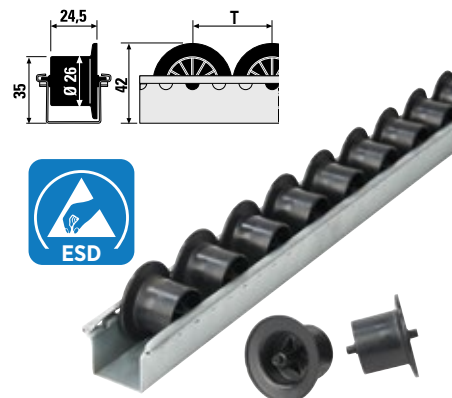

## Accessories



**A** Brake clips



**B** Roller track braces



**C** Brake rollers



**D** Brake shoes

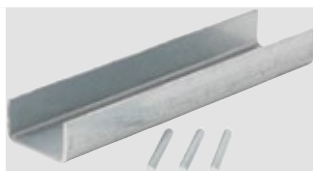

**E** Roller track connectors

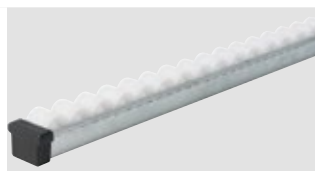

**F** Protective caps



**G** Push-back protection

Pos.	Description	Ref. no.	
<b>A</b>	Brake clips	reliable flow speed regulation, prevents products from getting damaged by a rough impact at the retrieval side, exerts a slight braking effect by blocking some rollers, ideal for lanes accommodating loads that differ a lot in weight, ideal for pressure sensitive products	36-7294
<b>B</b>	Roller track braces	prevents roller track sides from bending apart, required if heavy goods are loaded or in case of rough in-feeding of storage units at the loading side	36-16906
<b>C</b>	Brake rollers	optimum travel characteristics even if bins and cartons with a very different weight are fed into the same lane, allow to realise long lanes or lanes with a higher angle of incline, pressure-sensitive goods are smoothly braked, in general, a 6% incline is recommended for carton live storage levels, mounted in pairs at spacing intervals adapted to the length of loads (measured in travel direction), for maximum loads of 30 kg per storage unit, to be fitted into roller tracks by customer	36-29940
<b>D</b>	Brake shoes	suited for applications that need a higher braking force, this 275 mm long steel bracket is clipped on a series of rollers, provides a much stronger braking effect than a braking clip	36-7293
<b>E</b>	Roller track connectors	connects roller tracks with each other, enables end-to-end joining of profiles in long lanes, 3 distance holders prevent that roller track sides are pressed inwards at joining points, delivery includes fixing material + roller axles	36-11244
<b>F</b>	Protective caps	prevent injuries from roller tracks standing out at the front or the rear side of a flow shelf	36-28535
<b>G</b>	Push-back protection	prevents loads from dropping at the loading side if pushed back unintentionally at the retrieval side, supplied with steel axle, mainly used at the loading side, tilts forward when goods move to the picking side, prevents storage units from moving backwards when accidentally pushed against the flow direction	36-27011

## Carton live storage Flex

Robust make to suit all types of unit loads

- **Fast and easy order picking, short delivery times**
- **Modular system - racking bays and flow shelves can be added at any time**
- **Inclined position of bins provides a better view and allows faster and ergonomic picking**
- **Solid construction stands up to heavy loads**
- **Flow level spacing and incline can be adjusted as required**



PICKING OF UNIT LOADS



## Racking depth 1300 mm, useable depth 1200 mm

- Racking height 2500 mm: 3 straight levels, 2 levels with inclined picking front
- **Starter bays: 1 starter bay per racking row required. Bay width 2700 mm, total bay width 2820 mm.**
- **Extension bays: bay widths from 1350 mm to 2700 mm**

**TOP SELLER** !

36-44665



### **i** BITO info

#### **Assembly service**

For your convenience, each delivery comes with instructions for assembly and use for quick and easy installation. All assembly steps and directions of use are illustrated in detail. Upon request we are pleased to submit an offer for on-site installation by our experienced assembly teams.

Description	Bay width	Total width	Accommodates x containers 400 x 300 mm	Accommodates x containers 600 x 400 mm	Load cap. per level	Bay load	Ref. no.
	mm	mm	Pcs	Pcs	kg	kg	
Starter bay	2700	2820	120	60	460	2300	36-44665
Extension bay	1350	1410	60	30	450	2250	36-44666
	1800	1860	80	40	420	2100	36-44667
	2200	2260	100	50	400	2000	36-44668
	2700	2760	120	60	460	2300	36-44669

## Racking depth 2500 mm, useable depth 2400 mm

**TOP SELLER** !

36-44660



### **i** BITO info

#### **Assembly service**

For your convenience, each delivery comes with instructions for assembly and use for quick and easy installation. All assembly steps and directions of use are illustrated in detail. Upon request we are pleased to submit an offer for on-site installation by our experienced assembly teams.

Description	Bay width	Total width	Accommodates x containers 400 x 300 mm	Accommodates x containers 600 x 400 mm	Load cap. per level	Bay load	Ref. no.
	mm	mm	Pcs	Pcs	kg	kg	
Starter bay	2700	2820	240	120	480	2400	36-44660
Extension bay	1350	1410	120	60	450	2250	36-44661
	1800	1860	160	80	450	2250	36-44662
	2200	2260	200	100	450	2250	36-44663
	2700	2760	240	120	480	2400	36-44664



## Carton live storage Flex - Set offer

non-mobile version

Make sure that supplies don't run out ... and avoid down time!

- Ergonomic supply of parts and components at workstations
- 3 feeder levels equipped with 3 lanes each, i.e. 6 roller tracks and 2 dividers per level
- 1 return level (always supplied as straight level) with 8 roller tracks
- Maximum load capacity per level 250 kg
- Galvanised finish, epoxy-coated components in gentian blue, RAL 5010
- Supplied unassembled



### Bin capacity per supply shelving unit

36 European size stacking containers XL with L x W x H: 400 x 300 x 220 mm  
blue: 43-18520 / red: 43-14507

OR

18 European size stacking containers XL with L x W x H: 600 x 400 x 270 mm  
blue: 43-18492 / red: 43-14511

### Assembly service

For your convenience, each delivery comes with instructions for assembly and use for quick and easy installation. All assembly steps and directions of use are illustrated in detail. Upon request we are pleased to submit an offer for on-site installation by our experienced assembly teams.

PICKING OF UNIT LOADS



non-mobile version, straight feeder levels  
36-46050



non-mobile version, feeder levels with cranked picking face  
36-46051

Shelving height	Number of levels	External bay width	Bay width	External bay depth	Useable depth	Description	Ref. no.
mm		mm	mm	mm	mm		
2000	4	1470	1350	1300	1200	non-mobile version, straight feeder levels	36-46050
						non-mobile version, feeder levels with cranked picking face	36-46051

### Accessories



**A** European size stacking containers XL

Pos.	Description	External dimensions L x W x H	Colour	Ref. no.
		mm		
<b>A</b>	European size stacking containers XL	400 x 300 x 220	blue	43-18520
			red	43-14507
		600 x 400 x 270	blue	43-18492
			red	43-14511

## Carton live storage Flex - Set offer

### mobile version

Make sure that supplies don't run out ... and avoid down time!

- Ergonomic and mobile supply of parts and components at workstations
- 3 feeder levels equipped with 3 lanes each, i.e. 6 roller tracks and 2 dividers per level
- 1 return level (always supplied as straight level) with 8 roller tracks
- Maximum load capacity per level 250 kg
- Galvanised finish, epoxy-coated components in gentian blue, RAL 5010
- Supplied unassembled



#### Bin capacity per supply shelving unit

36 European size stacking containers XL with L x W x H: 400 x 300 x 220 mm  
blue: 43-18520 / red: 43-14507

OR

18 European size stacking containers XL with L x W x H: 600 x 400 x 270 mm  
blue: 43-18492 / red: 43-14511

#### Assembly service

For your convenience, each delivery comes with instructions for assembly and use for quick and easy installation. All assembly steps and directions of use are illustrated in detail. Upon request we are pleased to submit an offer for on-site installation by our experienced assembly teams.



PICKING OF UNIT LOADS



mobile version, straight feeder levels  
36-46052



mobile version, feeder levels with cranked picking face  
36-46053

Shelving height <i>mm</i>	Number of levels	External bay width <i>mm</i>	Bay width <i>mm</i>	External bay depth <i>mm</i>	Useable depth <i>mm</i>	Description	Ref. no.
2000	4	1470	1350	1300	1200	mobile version, feeder levels with cranked picking face	36-46053
						mobile version, straight feeder levels	36-46052

### Accessories



**A** European size stacking containers XL

Pos.	Description	External dimensions L x W x H <i>mm</i>	Colour	Ref. no.
<b>A</b>	European size stacking containers XL	400 x 300 x 220	blue	43-18520
red			43-14507	
		600 x 400 x 270	blue	43-18492
			red	43-14511

### Complete levels

#### with roller tracks

Clear the way for your products!

- For retro-fitting into existing pallet racking
- Roller tracks are installed with a standard spacing of approximately 100 mm and are equipped with cylindrical plastic rollers with a pitch of 28 mm
- Suited for storage in cartons or bins of different sizes
- Suited for cartons and bins weighing up to 20 kg
- For use with 50 mm wide beams
- Modules can be removed at any time and repositioned where required
- Convenient drop-in fitting of preassembled modules on existing beams



#### **i** BITO info

Please check the clear dimension (= useful depth) between the front and rear beams of your pallet racking!

Bay width <i>mm</i>	Number of modules	External bay depth <i>mm</i>	Useable depth <i>mm</i>	Shelf load <i>kg</i>	Ref. no.
2700	8	1100	1000	480	36-28868
		2400	2300	960	36-28400
		2450	2350	960	36-28401
3600	11	1100	1000	660	36-28869
		2400	2300	960	36-28402
		2450	2350	960	36-28403

### Accessories

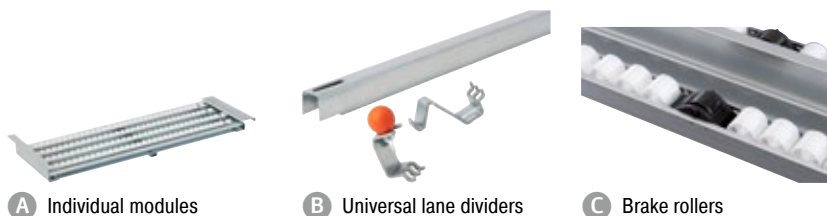

**A** Individual modules      **B** Universal lane dividers      **C** Brake rollers

Pos.	Description	Module width <i>mm</i>	External bay depth <i>mm</i>	Useable depth <i>mm</i>	Load capacity per segment <i>kg</i>	Ref. no.
<b>A</b>	Individual modules for easy-to-realise modifications and add-ons	322	1100	1000	60	36-28864
		322	2400	2300	120	36-28595
		322	2450	2350	120	36-28596
<b>B</b>	Universal lane dividers fast and convenient subdivision into lanes, re-adjustment of lane width is possible whenever required	-	1100	-	-	36-28858
		-	2400	-	-	36-28406
		-	2450	-	-	36-28407
<b>C</b>	Brake rollers	-	-	-	-	36-29940



## Complete levels

with roller conveyor lanes

Make your stock move!

- For retro-fitting into existing pallet racking
- Ideal for storage units with difficult travel characteristics
- Suited for loads of up to 30 kg
- Galvanised rollers, diameter 25 mm, roller pitch 84 mm
- For use with 50 mm wide beams
- Modules can be removed at any time and repositioned where required
- Convenient drop-in fitting of preassembled modules on existing beams



### **i** BITO info

Please check the clear dimension (= useful depth) between the front and rear beams of your pallet racking!

For a bay width of <i>mm</i>	Number of modules	External bay depth <i>mm</i>	Useable depth <i>mm</i>	Shelf load <i>kg</i>	Ref. no.
2700	6	1100	1000	480	36-54900
		2400	2300	960	36-28408
		2450	2350	960	36-28409
3600	8	1100	1100	640	36-54901
		2400	2300	1280	36-28410
		2450	2350	1280	36-28411

## Accessories



**A** Individual modules

Pos.	Description	Module width <i>mm</i>	External bay depth <i>mm</i>	Useable depth <i>mm</i>	Load capacity per segment <i>kg</i>	Ref. no.
<b>A</b>	Individual modules for easy-to-realise modifications and add-ons	446	1100	1000	80	36-39360
		446	2400	2300	160	36-28597
		446	2450	2350	160	36-28598





## Cantilever racking for light duty applications

### Cantilever racking for long loads – boltless assembly

Loads such as bars, tubes and pipes, sheet material, coils, offcuts and goods to be stored vertically – in short long and bulky items – have special storage requirements. For all these applications, BITO cantilever racking is the ideal storage system.

Whatever configuration or racking type is required – for single sided or double sided use, for rigid or flexible loads, bulky goods, coils or vertical storage – our experienced sales team will be pleased to advise you on the right racking type for your needs.

Cantilever arms and shelf levels can be adjusted in height without bolts. BITO cantilever racking can be supplied with a height up to 3700 mm, useful depths range from 400 to 850 mm.

**Please note:** Racking finishes supplied are intended for indoor use only!



CANTILEVER RACKING

**i**

All shelving and racking components fully comply with the latest German and international health and safety regulations (EN 15512 / DGUV 108-007).

BITO cantilever racking is manufactured to **RAL-RG 614/2** standards. This quality mark confirms that all our products are of superior quality.



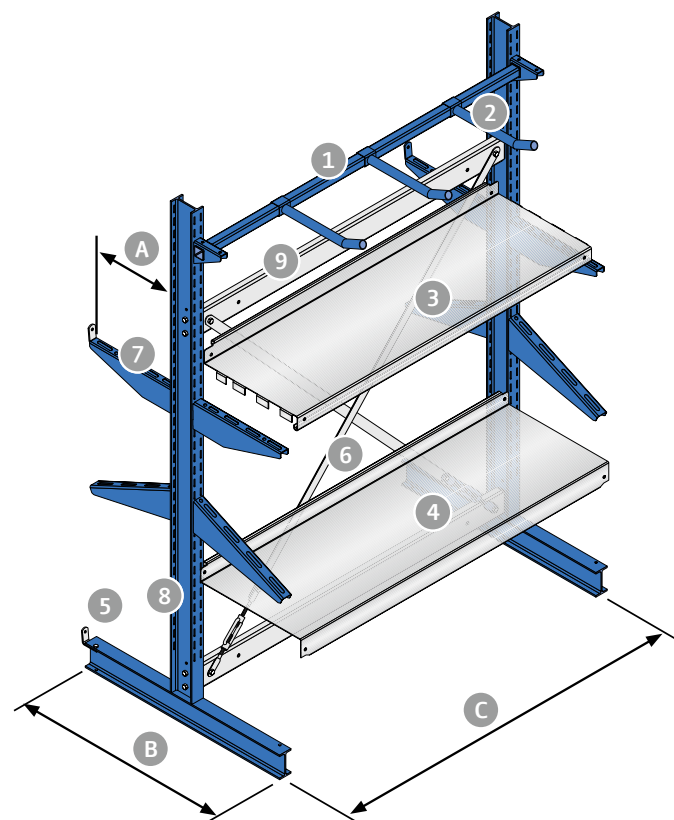

- (A) Useful depth
- (B) Depth of column feet
- (C) CTC-distance
- (1) Support rail for tubular arms
- (2) Tubular arm
- (3) Steel shelf
- (4) Base shelf
- (5) Column foot with end stop
- (6) Cross bracing
- (7) Cantilever arm with end stop
- (8) Column (double sided)
- (9) Connector

## Cantilever racking type L

with tubular arms

Perfect racking system for coils, cable dispensers and long items

- Load capacity per tubular arm 60 kg
- Tubular arms are adjustable without bolts in 60 mm increments along the column height
- Columns, tubular arms and support rails for tubular arms are epoxy-coated in gentian blue RAL 5010, all other components are galvanised
- Columns are made from European I-beams type IPE 100

**TOP SELLER**

20-18043

**Our offer:**

deliveries for single sided racking include 12 cantilever arms

H x W x D (racking depth): 1980 x 1115 x 500 mm

RAL 5010 Gentian blue

Ref. no. 20-18043

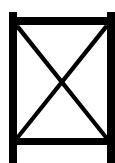
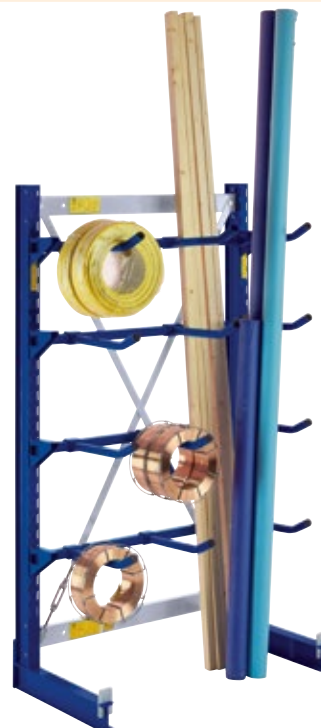

Width of starter bay  
1115 mm

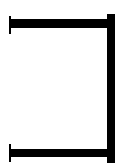

Width of extension bay  
1088 mm

Shelving height <i>mm</i>	Description	Number of round cantilever arms	External bay depth <i>mm</i>	Shelving type	Starter bay	Extension bay
				Useable depth <i>mm</i>	Ref. no.	Ref. no.
1980	with tubular arms single sided use	12	500	400	20-18043	20-18044
	with tubular arms double sided use	24	1100	2 x 400	20-18045	20-18046

### Accessories



**A** Tubular cantilever arms



**B** Support rail for tubular arms



Accessories to match from page 232

Pos.	Description		For a shelving depth of <i>mm</i>	Load capacity <i>kg</i>	Ref. no.
<b>A</b>	Tubular cantilever arms	can be positioned anywhere along the support rail, epoxy-coated in gentian blue, RAL 5010	400	60	20-18094
<b>B</b>	Support rail for tubular arms - Useful racking depth 500 - 850 mm	for tubular arms, <b>useable racking depth ranges from 500 to 850 mm</b> , epoxy-coated in gentian blue, RAL 5010	-	180	20-18093



## Cantilever racking type L

single sided use

Cantilever racking for long loads – boltless assembly

- Load cap. per level: max. 1320 kg
- Total load capacity: max. 7920 kg
- Height adjustable on a 60 mm pitch
- Cantilever arms and column feet are supplied with a 60 mm high end stop
- Columns are made from European I-beams type IPE 100/120
- Columns and tubular arms are epoxy-coated in gentian blue RAL 5010, all other components are galvanised

**TOP SELLER!**

20-17968

**Our offer:**

**Distance between column centres 1251 mm**  
 H x W x D (racking depth): 1980 x 5060 x 600 mm  
 Number of arms per column: 3  
 RAL 5010 Gentian blue  
 Ref. no. 20-17968

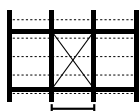

Distance between  
 centre lines  
 1061 mm

→ Accessories to match from page 232

Distance between centre lines	Shelving height	Number of arms per column	External bay width	Number of columns	Useable depth	External bay depth	Load cap. per level	Total load capacity	Ref. no.
mm	mm		mm		mm	mm	kg	kg	
1061	1980	4	3235	4	400	500	880	4400	20-17885
					500	600	700	3500	20-17886
					600	700	560	2800	20-17887
			4295	5	400	500	1100	5500	20-17888
					500	600	875	4375	20-17889
					600	700	700	3500	20-17890
			5356	6	400	500	1320	6600	20-17891
					500	600	1050	5250	20-17892
					600	700	840	4200	20-17893
	2480	5	3245	4	400	520	880	5280	20-17894
					500	620	700	4200	20-17895
					600	720	560	3360	20-17896
4305			5	400	520	1100	6600	20-17897	
				500	620	875	5280	20-17898	
				600	720	700	4200	20-17899	
5366			6	400	520	1320	7920	20-17900	
				500	620	1050	6300	20-17901	
				600	720	840	5040	20-17902	

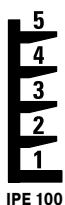

IPE 100



IPE 120

CANTILEVER RACKING

## Cantilever racking type L

double sided use

Plenty of room for long loads

- Load cap. per level: max. 1320 kg
- Total load capacity: max. 15840 kg
- Height adjustable on a 60 mm pitch
- Cantilever arms and column feet are supplied with a 60 mm high end stop
- Columns are made from European I-beams type IPE 100/120
- Columns and tubular arms are epoxy-coated in gentian blue RAL 5010, all other components are galvanised

**TOP SELLER!**

20-17884

Optionally:

Distance between column centres 1251 mm  
 H x W x D (racking depth): 1980 x 5060 x 1100 mm  
 Number of arms per column: 6  
 RAL 5010 Gentian blue  
 Ref. no. 20-17884

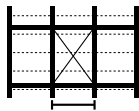

Distance between centre lines  
1061 mm



Accessories to match from page 232

Distance between centre lines <i>mm</i>	Shelving height <i>mm</i>	Number of arms per column	External bay width <i>mm</i>	Number of columns	Useable depth <i>mm</i>	External bay depth <i>mm</i>	Load cap. per level <i>kg</i>	Total load capacity <i>kg</i>	Ref. no.
1061	1980	<p>IPE 100</p>	3235	4	2 x 400	900	880	8800	20-17903
					2 x 500	1100	700	7000	20-17904
					2 x 600	1300	560	5600	20-17905
			4295	5	2 x 400	900	1100	11000	20-17906
					2 x 500	1100	875	8750	20-17907
					2 x 600	1300	700	7000	20-17908
			5356	6	2 x 400	900	1320	13200	20-17909
					2 x 500	1100	1050	10500	20-17910
					2 x 600	1300	840	8400	20-17911
	2480	<p>IPE 120</p>	3245	4	2 x 400	920	880	10560	20-17912
					2 x 500	1120	700	8400	20-17913
					2 x 600	1320	560	6720	20-17914
4305			5	2 x 400	920	1100	13200	20-17915	
				2 x 500	1120	875	10500	20-17916	
				2 x 600	1320	700	8400	20-17917	
5356			6	2 x 400	920	1320	15840	20-17918	
				2 x 500	1120	1050	12600	20-17919	
				2 x 600	1320	840	10080	20-17920	





## Cantilever racking type S

single sided use

Cantilever racking for very heavy long loads – boltless assembly

- Load cap. per level: max. 2880 kg
- Total load capacity: max. 17280 kg
- Columns and tubular arms are epoxy-coated in gentian blue RAL 5010, all other components are galvanised
- Height adjustable on a 60 mm pitch
- Columns are made from European I-beams type IPE 140

**TOP SELLER!**

20-17969

**Our offer:**

**Distance between column centres 1251 mm,** useful depth 600 mm  
 (We do not offer shelves for cantilever arms and for column feet in cantilever racking with a CTC-distance of 1251 mm.)  
 H x W x D (racking depth): 2500 x 5080 x 740 mm  
 RAL 5010 Gentian blue  
 Ref. no. 20-17969

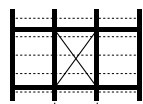
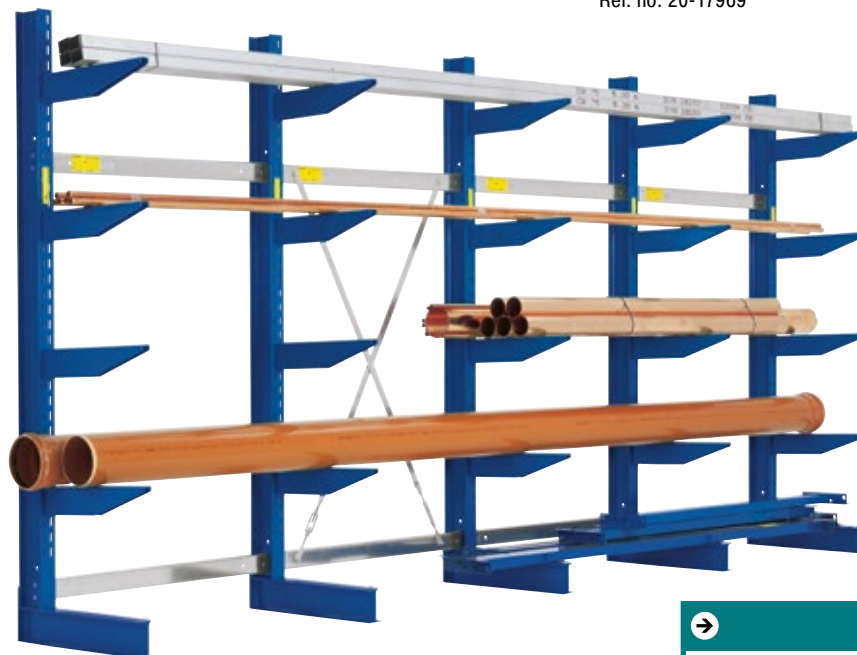

Distance between  
 centre lines  
 1061 mm  
 1251 mm

→ Accessories to match from page 232

CANTILEVER RACKING

Shelving height	Number of arms per column	Distance between centre lines	External bay width	Number of columns	Useable depth	External bay depth	Load cap. per level	Total load capacity	Ref. no.
mm		mm	mm		mm	mm	kg	kg	
2500	<p>IPE 140</p>	1061	3255	4	400	540	1920	11520	20-17971
					500	640	1640	9840	20-17972
					600	740	1320	7920	20-17973
					850	990	1080	6480	20-17974
			4316	5	400	540	2400	14400	20-17975
					500	640	2050	12300	20-17976
					600	740	1650	9900	20-17977
					850	990	1350	8100	20-17978
			5376	6	400	540	2880	17280	20-17979
					500	640	2460	14760	20-17980
					600	740	1980	11850	20-17981
					850	990	1620	9720	20-17982
		1251	2576	3	400	540	1440	8640	20-17995
					500	640	1230	7380	20-17996
					600	740	990	5940	20-17997
					850	990	810	4860	20-17998
			3828	4	400	540	1920	11520	20-17999
					500	640	1640	9840	20-18000
					600	740	1320	7920	20-18001
					850	990	1080	6480	20-18002
			5080	5	400	540	2400	14400	20-18003
					500	640	2050	12300	20-18004
					600	740	1650	9900	20-18005
					850	990	1350	8100	20-18006

## Cantilever racking type S

double sided use

Ideal for accommodating heavy weight and long loads

- Load cap. per level: max. 2880 kg
- Total load capacity: max. 34560 kg
- Columns and tubular arms are epoxy-coated in gentian blue RAL 5010, all other components are galvanised
- Height adjustable on a 60 mm pitch
- Columns are made from European I-beams type IPE 140

**TOP SELLER!**

20-17970

Set offer with 1 starter bay and 1 extension bay:

Distance between column centres 1251 mm, useful depth 600 mm  
(We do not offer shelves for cantilever arms and for column feet in cantilever racking with a CTC-distance of 1251 mm.)

H x W x D (racking depth): 2500 x 5080 x 1340 mm

RAL 5010 Gentian blue

Ref. no. 20-17970

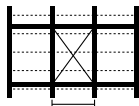

Distance between centre lines

1061 mm

1251 mm



Accessories to match from page 232

Shelving height	Number of arms per column	Distance between centre lines	External bay width	Number of columns	Useable depth	External bay depth	Load cap. per level	Total load capacity	Ref. no.	
mm		mm	mm		mm	mm	kg	kg		
2500	<p>IPE 140</p>	1061	3255	4	2 x 400	940	1920	23040	20-17983	
			4316	5	2 x 400	940	2400	28800	20-17987	
			5376	6	2 x 400	940	2880	34560	20-17991	
			3255	4	2 x 500	1140	1640	19680	20-17984	
					2 x 600	1340	1320	15840	20-17985	
					2 x 850	1840	1080	12960	20-17986	
			4316	5	2 x 500	1140	2050	24600	20-17988	
					2 x 600	1340	1650	19800	20-17989	
					2 x 850	1840	1350	16200	20-17990	
			5376	6	2 x 500	1140	2460	29520	20-17992	
		2 x 600			1340	1980	23760	20-17993		
		2 x 850			1840	1620	19440	20-17994		
		1251		2576	3	2 x 400	940	1440	17280	20-18007
						2 x 400	940	1920	23040	20-18011
						2 x 400	940	2400	28800	20-18015
				2576	3	2 x 500	1140	1230	14760	20-18008
						2 x 600	1340	990	11880	20-18009
						2 x 850	1840	810	9720	20-18010
				3828	4	2 x 500	1140	1640	19680	20-18012
						2 x 600	1340	1320	15840	20-18013
2 x 850	1840					1080	12960	20-18014		
5080	5			2 x 500	1140	2050	24600	20-18016		
		2 x 600	1340	1650	19800	20-18017				
		2 x 850	1840	1350	16200	20-18018				



## Cantilever racking components type L and S

CANTILEVER RACKING



### Cantilever racking columns, single sided use

- All columns are supplied with floor anchors, shims and bolts for connector beams
- Epoxy-coated in gentian blue, RAL 5010

Description	Profile type	Height <i>mm</i>	Useable depth	Load capacity	Ref. no.
			<i>mm</i>	<i>kg</i>	
type L	IPE 100	1980	400	1000	20-18050
			500	850	20-18051
			600	725	20-18052
	IPE 120	2480	400	1400	20-18056
			500	1225	20-18057
			600	1075	20-18058
type S	IPE 140	2500	400	2400	20-18062
			500	2050	20-18063
			600	1775	20-18064
			850	1350	20-18065
		3220	400	2225	20-18070
			500	1850	20-18071
			600	1600	20-18072
			850	1150	20-18073
		3700	400	1900	20-18078
			500	1600	20-18079
			600	1375	20-18080
				850	1000

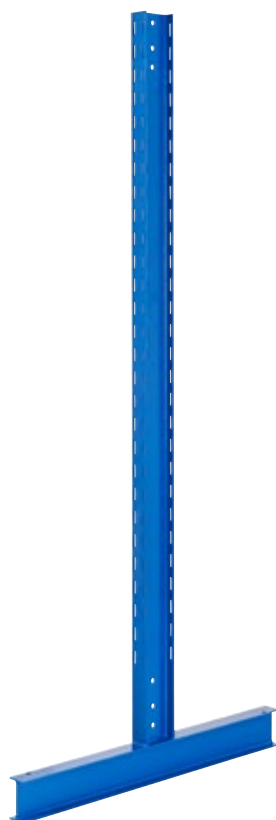

### Cantilever racking columns, double sided use

- All columns are supplied with floor anchors, shims and bolts for connector beams
- Epoxy-coated in gentian blue, RAL 5010

Description	Profile type	Height <i>mm</i>	Useable depth	Load capacity	Ref. no.
			<i>mm</i>	<i>kg</i>	
type L	IPE 100	1980	2 x 400	2000	20-18053
			2 x 500	1700	20-18054
			2 x 600	1450	20-18055
	IPE 120	2480	2 x 400	2800	20-18059
			2 x 500	2450	20-18060
			2 x 600	2150	20-18061
type S	IPE 140	2500	2 x 400	4800	20-18066
			2 x 500	4100	20-18067
			2 x 600	3550	20-18068
			2 x 850	2700	20-18069
		3220	2 x 400	4450	20-18074
			2 x 500	3700	20-18075
			2 x 600	3200	20-18076
			2 x 850	2300	20-18077
		3700	2 x 400	3800	20-18082
			2 x 500	3200	20-18083
			2 x 600	2750	20-18084
				2 x 850	2000

## Accessories

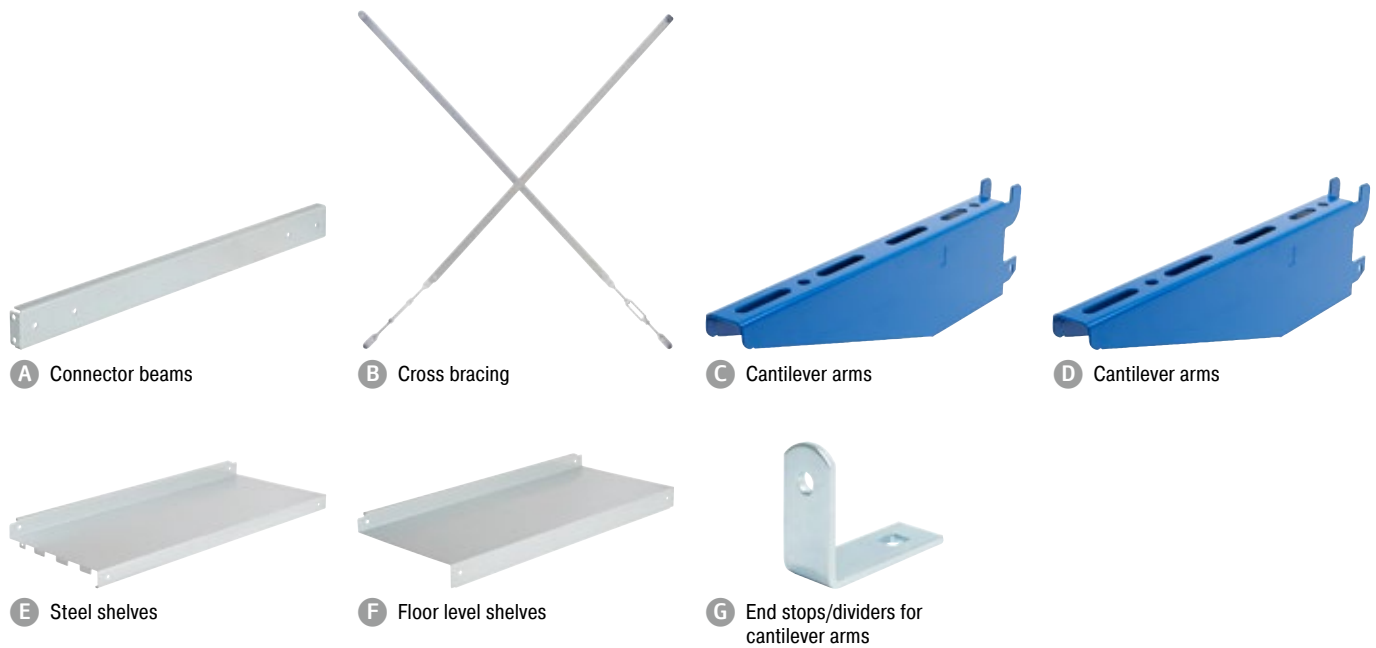

Pos.	Description	For a shelving depth of <i>mm</i>	Load capacity <i>kg</i>	Dimensions <i>mm</i>	Ref. no.	
A	Connector beams	to suit type L and S, galvanised, 2 connector beams are required per bay, 3 beams for racking heights of 3 metres and higher, bolts are supplied together with column delivery	-	-	L 1057	20-11991
			-	-	L 1247	20-11990
B	Cross bracing	to suit type L and S, galvanised, 1 cross bracing set required for every 5th bay in a row, supplied with bolts	-	-	L 1650	20-2274
C	Cantilever arms	type L, incl. safety pin, height adjustable on a 60 mm pitch, hook-in mounting, epoxy-coated in gentian blue, RAL 5010	400	220	L 400	20-18086
			500	175	L 500	20-18087
			600	140	L 600	20-18088
D	Cantilever arms	type S, incl. safety pin, height adjustable on a 60 mm pitch, hook-in mounting, epoxy-coated in gentian blue, RAL 5010	400	550	L 400	20-18089
			500	430	L 500	20-18090
			600	330	L 600	20-18091
			850	300	L 850	20-18092
E	Steel shelves	galvanised, drop-on fitting onto cantilever arms, shelf length 1057 mm to fit a distance of 1061 mm between column centre lines, please mind load capacity of cantilever arms!, <b>not available for a clear depth of 850 mm and for a distance of 1251 mm between column centres</b>	400	360	L 1057	20-2799
			500	360	L 1057	20-2800
			600	330	L 1057	20-2801
F	Floor level shelves	galvanised, drop-on fitting onto column feet, shelf length 1057 mm to fit a distance of 1061 mm between column centre lines, please mind load capacity of cantilever arms!, <b>not available for a clear depth of 850 mm and for a distance of 1251 mm between column centres</b>	400	460	L 1057	20-2277
			500	420	L 1057	20-2278
			600	370	L 1057	20-2279
G	End stops/dividers for cantilever arms	for column feet, galvanised, incl. bolts	-	-	L 76 x W 30 x H 60	20-18665
		supplied with bolts, for cantilever arms, height 60 mm, galvanised, incl. bolts	-	-	L 76 x W 30 x H 60	20-2275
		for column feet, galvanised, incl. bolts	-	-	L 76 x W 30 x H 150	20-18666
		for cantilever arms, galvanised, incl. bolts	-	-	L 76 x W 30 x H 150	20-2276







## Racks for vertical storage

single sided use

- Space saving vertical storage of light-weight long loads such as profiles, tubes, sheet material
- Optionally available dividers allow neat storage of long loads and facilitate access to products
- Sturdy construction consisting of a bolted frame with hook-in beams and a galvanised tray shelf on the floor. Beams can be adjusted in height on a 50 mm pitch.
- Easy hook-in / bolt-on fitting: beams are hooked into pre-assembled frames, tray shelf must be bolted to frame feet
- Frames are epoxy-coated in blue RAL 5010, horizontal and diagonal strutting galvanised
- Beams are epoxy-coated in light grey RAL 7035, with welded connector for easy hook-in fitting
- Supplied with floor anchoring



RACKS FOR VERTICAL STORAGE



Height	Useable width	Useable depth	Total bay load capacity	Total width	External bay depth	Description	Ref. no.
<i>mm</i>	<i>mm</i>	<i>mm</i>	<i>kg</i>	<i>mm</i>	<i>mm</i>		
2500	1500	340	130	1600	600	Starter bay	58-48110
				1550	600	Extension bay	58-48111
		500	110	1600	760	Starter bay	58-48114
				1550	760	Extension bay	58-48115
	1800	340	130	1900	600	Starter bay	58-48112
				1850	600	Extension bay	58-48113
		500	110	1900	760	Starter bay	58-48116
				1850	760	Extension bay	58-48117

## Racks for vertical storage

double sided use



RACKS FOR VERTICAL STORAGE

Height	Useable width	Useable depth	Total bay load capacity	Total width	External bay depth	Description	Ref. no.
<i>mm</i>	<i>mm</i>	<i>mm</i>	<i>kg</i>	<i>mm</i>	<i>mm</i>		
2500	1500	2 x 340	130	1600	1200	Starter bay	58-48118
				1550	1200	Extension bay	58-48119
		2 x 500	110	1600	1520	Starter bay	58-48122
				1550	1520	Extension bay	58-48123
	1800	2 x 340	130	1900	1200	Starter bay	58-48120
				1850	1200	Extension bay	58-48121
		2 x 500	110	1900	1520	Starter bay	58-48124
				1850	1520	Extension bay	58-48125

## Accessories



A Wire divider with label holder



B Divider bars



C Vertical wire divider

Pos.	Description	Useable depth	Description	Ref. no.	
		<i>mm</i>			
A	Wire divider with label holder	6 mm wire with welded connectors for easy hook-in-fitting, epoxy-coated in light grey, RAL 7035	500	left end	58-48140
			500	divider arm for further subdivision	58-48139
			500	right end	58-48138
			350	left end	58-48137
			350	divider arm for further subdivision	58-48136
			350	right end	58-48135
B	Divider bars	profile 35 x 20 mm, with welded connectors for easy hook-in-fitting, epoxy-coated in light grey, RAL 7035	500	left end	58-48134
			500	divider arm for further subdivision	58-48133
			500	right end	58-48132
			350	left end	58-48131
			350	divider arm for further subdivision	58-48130
			350	right end	58-48129
C	Vertical wire divider	steel tube Ø 20 mm, with welded connectors for easy hook-in-fitting, epoxy-coated in light grey, RAL 7035	500	left end	58-48128
			500	divider arm for further subdivision	58-48127
			500	right end	58-48126

## Cantilever racking for heavy duty applications

### Bolted racking for very heavy long loads

All components of our heavy duty cantilever racking come in standardised dimensions and can be combined to suit your needs. This means that you can tailor your racking to adapt to the features of your storage location (indoor or outdoor) as well as to the size and the weight of your goods. Your cantilever racking can also be integrated into existing storage concepts.

If you prefer to let us do the planning, we are pleased to work out custom offers. Let us provide you with the right cantilever racking system for your application!

#### We deliver superior quality:

- for indoor use, components are painted and for outdoor use, they are hot-dip galvanised.
- Stiffening and connecting components are galvanised in compliance with **EN 10326**.
- Cantilever arms can be adjusted in height on a 100 mm pitch.
- Cantilever racking can be supplied for single sided and double sided use.





- ① Column
- ② Cantilever arm
- ③ Connector beam
- ④ Cross bracing
- ⑤ Arm bridge

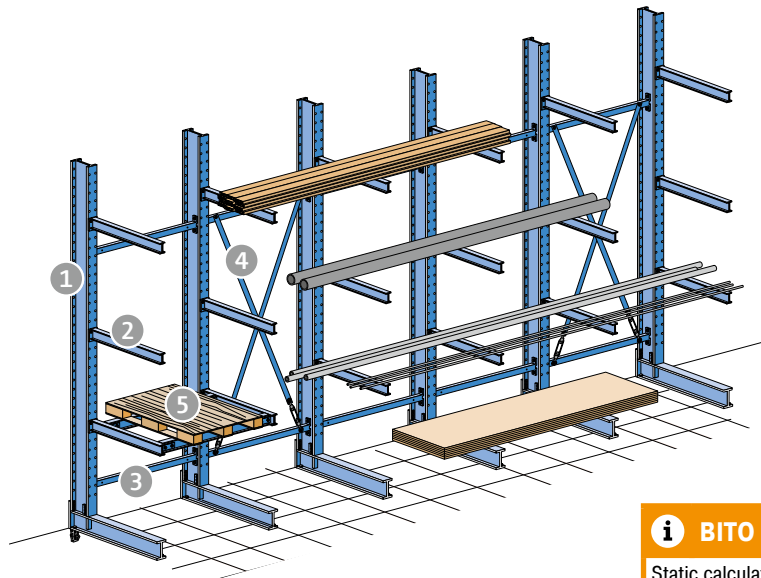

**i BITO info**  
 Static calculations and constructional features are in compliance with **DIN 18800** standards.

## Components

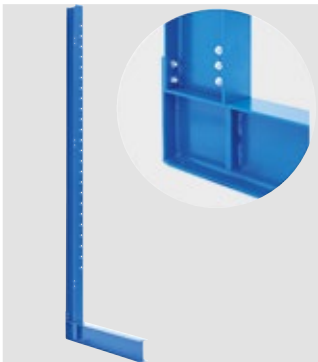

### Frames

- Columns and feet are supplied for self assembly (bolt-together construction)
- Columns and feet are manufactured from hot-rolled IPE profiles
- Delivery includes floor anchors
- Columns and feet can be supplied for single sided and for double sided use



### Cantilever arms

- All cantilever arms are supplied with an end stop as standard
- The tapered side is pre-drilled for end stop fixing



### Connector beams

- Connect columns with each other to make a solid racking row
- Take the cross bracing sets



### Cross bracing

- Provide lateral racking stability
- Quantity and arrangement per racking row is project related

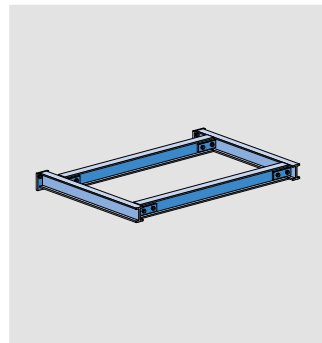

### Arm bridges

- Bolted construction for pallet storage

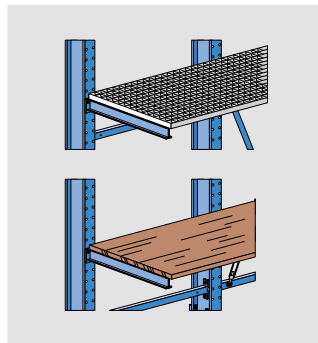

### Shelves

- Supplied as wire-mesh shelves or as chipboard shelves depending on items to be stored







## Cantilever racking type ES

single sided use

Complete cantilever racking units for extremely heavy loads

- Load cap. per level: max. 1800 kg
- Total load capacity: max. 12600 kg
- Cantilever arms are adjustable on a 100 mm pitch
- Columns are made from European I-beams type IPE 180/200
- Columns and cantilever arms are epoxy-coated in gentian blue RAL 5010, all other components are galvanised
- Cantilever arms from IPE 80 profiles

**TOP SELLER**

21-37512

**Our offer:**

Distance between upright centre lines: 1500 mm

H x W x D (racking depth): 3000 x 4600 x 1180 mm

RAL 5010 Gentian blue

Ref. no. 21-37512

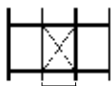

Distance between centre lines  
1500 mm

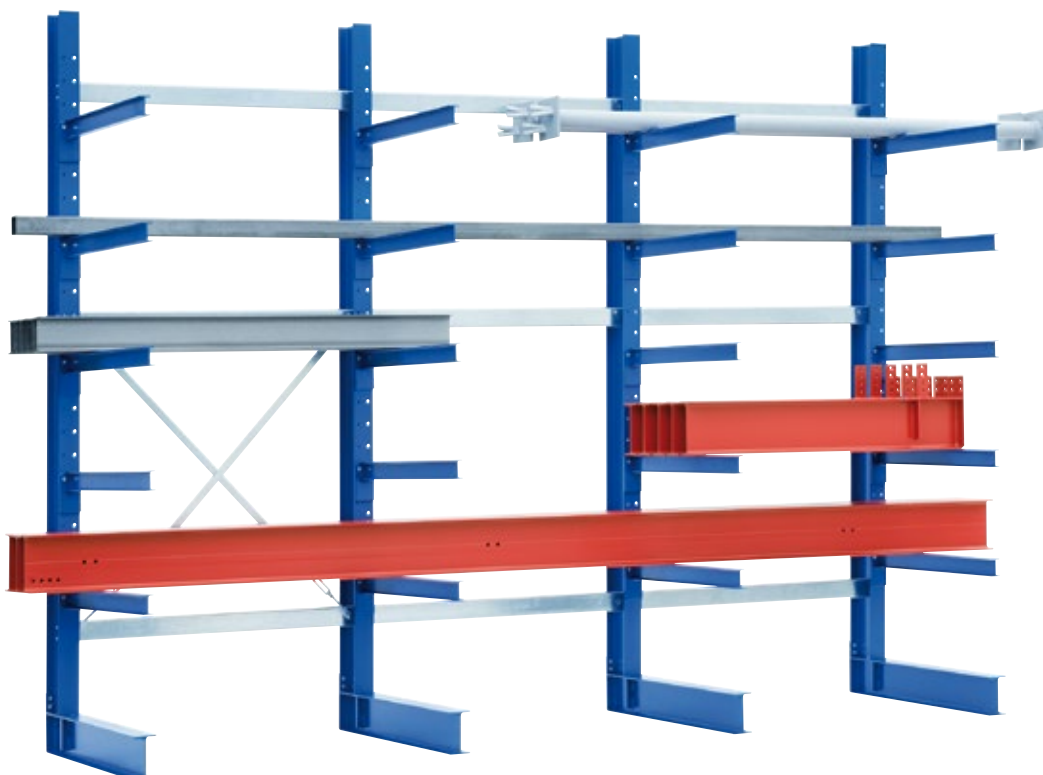

CANTILEVER RACKING

Distance between centre lines	Shelving height	Number of arms per column	External bay width	Number of columns	Useable depth	External bay depth	Load cap. per level	Total load capacity	Ref. no.
mm	mm		mm		mm	mm	kg	kg	
1500	3000	5	1600	2	1000	1180	900	5400	21-37510
			3100	3	1000	1180	1350	8100	21-37511
			4600	4	1000	1180	1800	10800	21-37512
	4000	6	1600	2	1000	1200	900	6300	21-37515
			3100	3	1000	1200	1350	9450	21-37513
			4600	4	1000	1200	1800	12600	21-37514



## Cantilever racking type ES

double sided use

Complete cantilever racking units for extremely heavy loads

- Load cap. per level: max. 1800 kg
- Total load capacity: max. 25200 kg
- Cantilever arms are adjustable on a 100 mm pitch
- Columns are made from European I-beams type IPE 180/200
- Columns and cantilever arms are epoxy-coated in gentian blue RAL 5010, all other components are galvanised
- Cantilever arms from IPE 80 profiles

**Our offer:**

Distance between upright centre lines: 1500 mm  
 H x W x D (racking depth): 3000 x 4600 x 2180 mm  
 RAL 5010 Gentian blue  
 Ref. no. 21-37518

**TOP SELLER!**  
21-37518

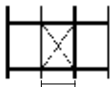
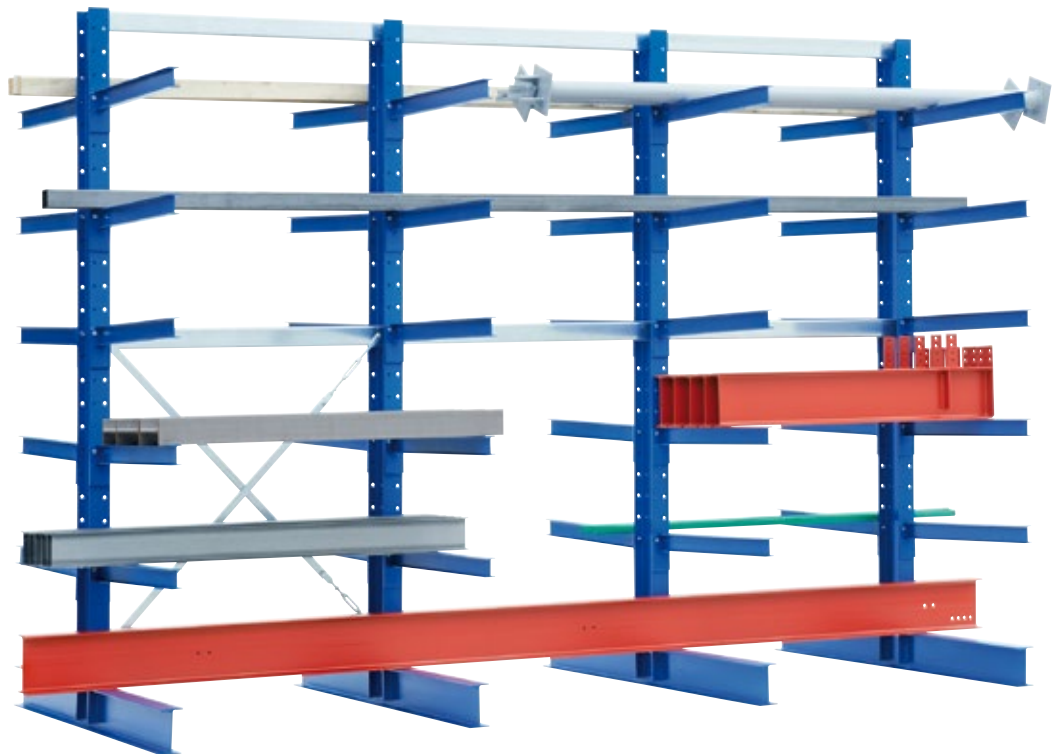

Distance between centre lines  
1500 mm



CANTILEVER RACKING

Distance between centre lines	Shelving height	Number of arms per column	External bay width	Number of columns	Useable depth	External bay depth	Load cap. per level	Total load capacity	Ref. no.
mm	mm		mm		mm	mm	kg	kg	
1500	3000	<p>IPE 180</p>	1600	2	2 x 1000	2180	900	10800	21-37516
			3100	3	2 x 1000	2180	1350	16200	21-37517
			4600	4	2 x 1000	2180	1800	21600	21-37518
			4000	12	1600	2	2 x 1000	2200	900
		<p>IPE 200</p>	3100	3	2 x 1000	2200	1350	18900	21-37519
			4600	4	2 x 1000	2200	1800	25200	21-37520

**Cantilever racking components type ES**

Bolted racking for very heavy long loads

**Cantilever racking columns, single sided use**

- Column profiles IPE 180 - 300 and column heights of 3000, 4000 and 5000 mm allow maximum flexibility in use
- All columns are supplied with floor anchors and shims
- Painted in gentian blue, RAL 5010

Height <i>mm</i>	Useable depth <i>mm</i>	Load capacity <i>kg</i>	Profile type	Ref. no.
3000	1000	2750	IPE 180	21-37522
	1250	3200	IPE 200	21-37523
	1500	3600	IPE 220	21-37524
4000	1000	3400	IPE 200	21-37525
	1250	3950	IPE 220	21-37526
	1500	4550	IPE 240	21-37527
5000	1000	5100	IPE 240	21-37528
	1250	6200	IPE 270	21-37529
	1500	7350	IPE 300	21-37530

**Cantilever racking columns, double sided use**

- Column profiles IPE 180 - 300 and column heights of 3000, 4000 and 5000 mm allow maximum flexibility in use
- All columns are supplied with floor anchors and shims
- Painted in gentian blue, RAL 5010

Height <i>mm</i>	Useable depth <i>mm</i>	Load capacity <i>kg</i>	Profile type	Ref. no.
3000	2 x 1000	5500	IPE 180	21-37531
	2 x 1250	6400	IPE 200	21-37532
	2 x 1500	7200	IPE 220	21-37533
4000	2 x 1000	6800	IPE 200	21-37534
	2 x 1250	7900	IPE 220	21-37535
	2 x 1500	9100	IPE 240	21-37536
5000	2 x 1000	10200	IPE 240	21-37537
	2 x 1250	12400	IPE 270	21-37538
	2 x 1500	14700	IPE 300	21-37539

**Connector beams, type ES**

- Galvanised finish
- Suited for 1000, 1250 and 1500 mm wide bays
- Delivery includes fixing material

Length <i>mm</i>	Bay width <i>mm</i>	Ref. no.
997	1000	21-37464
1247	1250	21-37465
1497	1500	21-37466

For a bay width of <i>mm</i>	Height		
	3000 mm	4000 mm	5000 mm
1000	2 connector beams	3 connector beams	3 connector beams
1250	2 connector beams	3 connector beams	3 connector beams
1500	2 connector beams	2 connector beams	3 connector beams

CANTILEVER RACKING

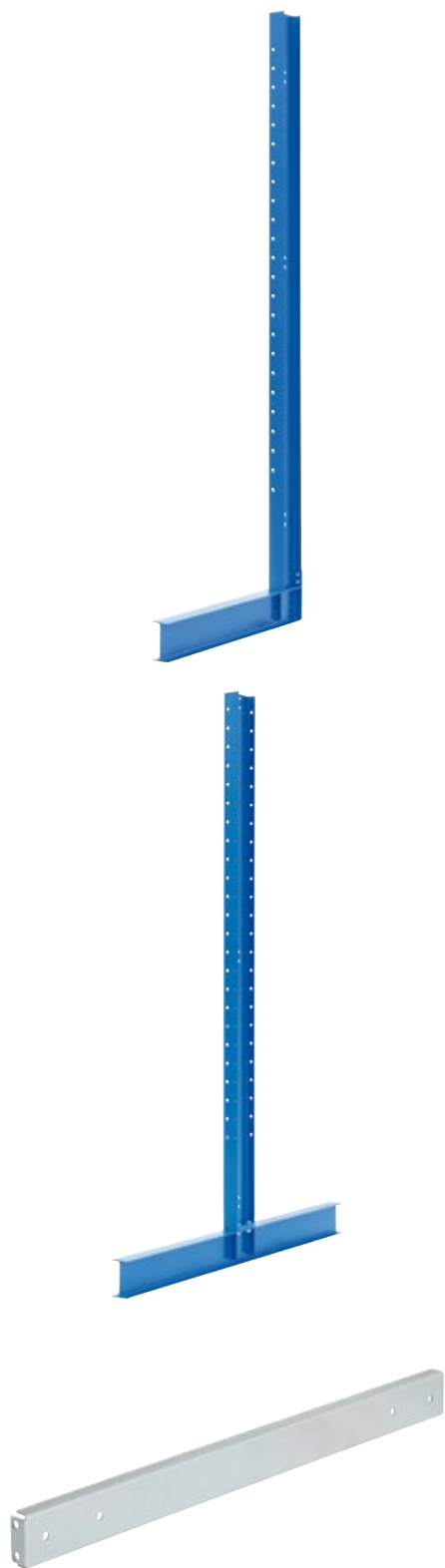

## Cantilever arms, type ES

- Useable depth of 1000, 1250 and 1500 mm
- IPE 80 - 160 profiles for maximum flexibility in use
- Painted in gentian blue, RAL 5010
- Delivery includes fixing material
- Bolt-on fixing to columns



Description	For a shelving depth of <i>mm</i>	Load capacity <i>kg</i>	Profile type	Ref. no.
for use with columns made from IPE sections 180 - 220	1000	450	IPE 80	21-37379
		750	IPE 100	21-37400
		1150	IPE 120	21-37421
	1250	350	IPE 80	21-37380
		600	IPE 100	21-37401
		950	IPE 120	21-37422
	1500	300	IPE 80	21-37381
		500	IPE 100	21-37402
		750	IPE 120	21-37423
1350		IPE 120	21-37428	
for use with columns made from IPE sections 240 - 300	1000	1900	IPE 140	21-37442
		2100	IPE 160	21-37456
		1050	IPE 120	21-37429
	1250	1500	IPE 140	21-37443
		1750	IPE 160	21-37457
		900	IPE 120	21-37430
	1500	1250	IPE 140	21-37444
		1400	IPE 160	21-37458

## Cross bracing, type ES

- Added lengthwise rigidity
- Galvanised
- Delivery includes fixing material

Length <i>mm</i>	Ref. no.
1750	21-37473
2000	21-37474
2250	21-37481
2500	21-37482
2750	21-37483
3500	21-37484

For a bay width of <i>mm</i>	Height		
	3000 mm	4000 mm	5000 mm
1000	1x 21-37481 (2250 mm)	2x 21-37473 (1750 mm)	2x 21-37481 (2250 mm)
1250	1x 21-37482 (2500 mm)	2x 21-37474 (2000 mm)	2x 21-37482 (2500 mm)
1500	1x 21-37483 (2750 mm)	1x 21-37484 (3500 mm)	2x 21-37482 (2500 mm)

The first two bays of a racking row must be fitted with 1 cross bracing set each. The next cross bracing set must be fitted to the 6th bay and, in longer rows, to every 5th following bay.







## Racks for sheets and boards

- Rack base from galvanised steel sheet with grooves for easy sheet material positioning, the square-tubed frame provides stable footing
- Galvanised push-in dividers bars, additionally secured with bolts



SHEET/PLATE RACKS

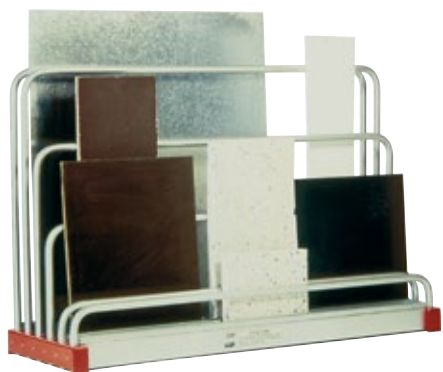

### Sheet/plate racks for oddments

- Divider bars 2 x 120 mm, 1 x 385 mm, 1 x 640 mm and 2 x 900 mm, allowing storage of pieces in a wide variety of sizes and materials
- Neat presentation saves time and money
- Saves time and money
- Encourages re-use of oddments, fast return on investment
- Designed for storing sheet materials from PVC, laminates, cardboard or sheet steel
- Suitable for sheets up to 4 mm thick and for materials with a specific weight up to 9 kg/dm<sup>3</sup>

Dimensions L x W x H	Section width	Number of compartments	Height of divider bars	Load cap./pce	Formats (from - to)	Ref. no.
<i>mm</i>	<i>mm</i>				<i>mm</i>	
1600 x 480 x 1000	50	5	2 x 120 / 1 x 385 / 1 x 640 / 2 x 900	200	80 x 120 - 1600 x 1600	22-14908

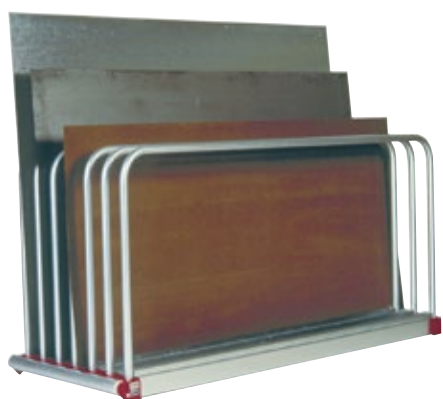

### Sheet/plate racks

- Divider bars are 900 mm high
- Accommodates sheet materials from PVC, laminates, cardboard or steel, load capacity of up to 9 tonnes
- Neat presentation saves time and money
- Goods are within immediate reach
- Can be handled by one person

Dimensions L x W x H	Section width	Number of compartments	Height of divider bars	Load cap./pce	Formats (from - to)	Ref. no.
<i>mm</i>	<i>mm</i>				<i>mm</i>	
2030 x 560 x 1000	45	6	900	1000	2000 x 1000 - 3000 x 1500	22-14909
2030 x 800 x 1000	45	9	900	1000	2000 x 1000 - 3000 x 1500	22-14910
	85	6	900	750	2000 x 1000 - 3000 x 2000	22-14911

## Wire-mesh partitions

for heavy duty applications

- Sturdy steel tube framework, Ø 32 mm
- Protects valuable goods and equipment and delimits production and warehouse areas
- Mesh size 50 x 50 x 4 mm
- Fast and easy to assemble
- Brackets for bolt-on fixing to posts
- Tensioning screws between posts and ceiling provide additional stability
- Posts and mesh panels painted in gentian blue, RAL 5010 or reseda green, RAL 6011

### Wall panels, for heavy duty applications

- All-welded construction
- Supplied without posts



Dim. without brackets <i>mm</i>	Distance between upright centre lines <i>mm</i>	Ref. no.
W 815 x H 2200	975	22-18534
W 1550 x H 2200	1710	22-18535

#### **i** BITO info

Other configurations and colours upon request.

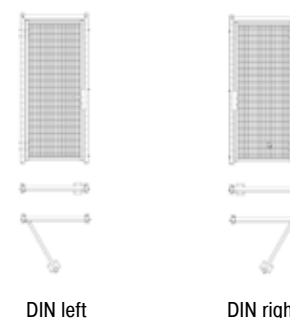
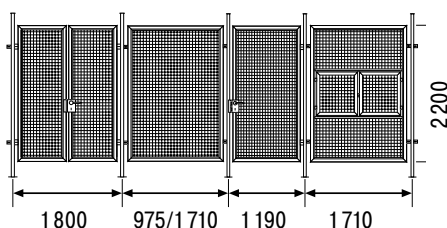

### Accessories

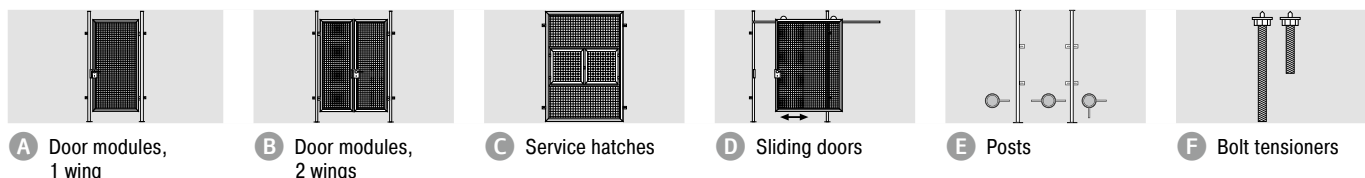

Pos.	Description	Dim. without brackets <i>mm</i>	Distance between upright centre lines <i>mm</i>	Clear width/ height <i>mm</i>	Description	Ref. no.	
A	Door modules, 1 wing	door panels opening optionally to right-hand or to left-hand side as specified by DIN, complete with 2 posts, door handle set with stop plate and lock	W 1070 x H 2200	1190	1070/2350	DIN left	22-18539
			W 1070 x H 2200	1190	1070/2350	DIN right	22-18540
B	Door modules, 2 wings	complete with 2 posts, locking bolt at floor height, door handle set with stop plate and lock, supplied with welded nuts at the upper end for tensioning screws to ensure a solid connection to the ceiling (supplied without anchor bolts)	W 1690 x H 2200	1800	1680/2350	DIN left	22-18541
			W 1690 x H 2200	1800	1680/2350	DIN right	22-18542
C	Service hatches	mesh infill wall panels with 2-wing hatch, stop plate and hasp and staple facility for customer-fitted padlock (delivery without posts)	W 1550 x H 2200	1710		standard version	22-18536
D	Sliding doors	complete with 2 posts, runner rail, fasteners and guide rails, door handle and hook lock, ready for mounting locking cylinder (to be fitted by customer), supplied with welded nuts at the upper end for tensioning screws to ensure a solid connection to the ceiling (supplied without anchor bolts)	W 1800 x H 2200	1800	1700/2350	standard version	22-18543
E	Posts	60 mm steel tube with pre-drilled base plate and brackets for wall panel fixing, supplied with welded nuts at the upper end for tensioning screws to ensure a solid connection to the ceiling (supplied without anchor bolts)	W 60 x H 2500			Corner post	22-18538
			W 60 x H 2500			Line end post	22-18546
			W 60 x H 2500			In-line post	22-18537
F	Bolt tensioners	lock posts tightly between floor and ceiling, long bolts to allow adjustment to various room heights	L 500			for wire partitions	22-18544
			L 1000			for wire partitions	22-18545



**Aim high, stay safe!**

STEPS & LADDERS



In almost any warehouse or storage room operators will need suitable access equipment for loading and retrieving products. Our selection of shelving ladders, access platforms and kicksteps focusses on safety. Without exception, all products have been manufactured in Germany and have been awarded the quality mark "Made in Germany" by the TÜV NORD, an international certification body headquartered in Hanover, Germany, that is working with independent experts to assess the quality and safety of technical products. As all products provided on the following pages have been manufactured to the strictest standards of quality, we are able to offer our customers a 15 year warranty.



Contents



STEPS & LADDERS

**Shelving access ladders and A-frame ladders .. 246**

- Shelving access ladders from aluminium ..... 246
- Aluminium folding steps..... 248
- Aluminium folding steps..... 249
- Mobile aluminium platform ladders ..... 250

**Step ladders ..... 250**

- Mobile aluminium access ladders ..... 251
- Mobile access platforms ..... 252
- Mobile aluminium access platforms ..... 254

**Platform steps ..... 255**

- Aluminium folding steps..... 255
- Aluminium platform steps..... 256
- Kick steps ..... 257
- Step stools ..... 257

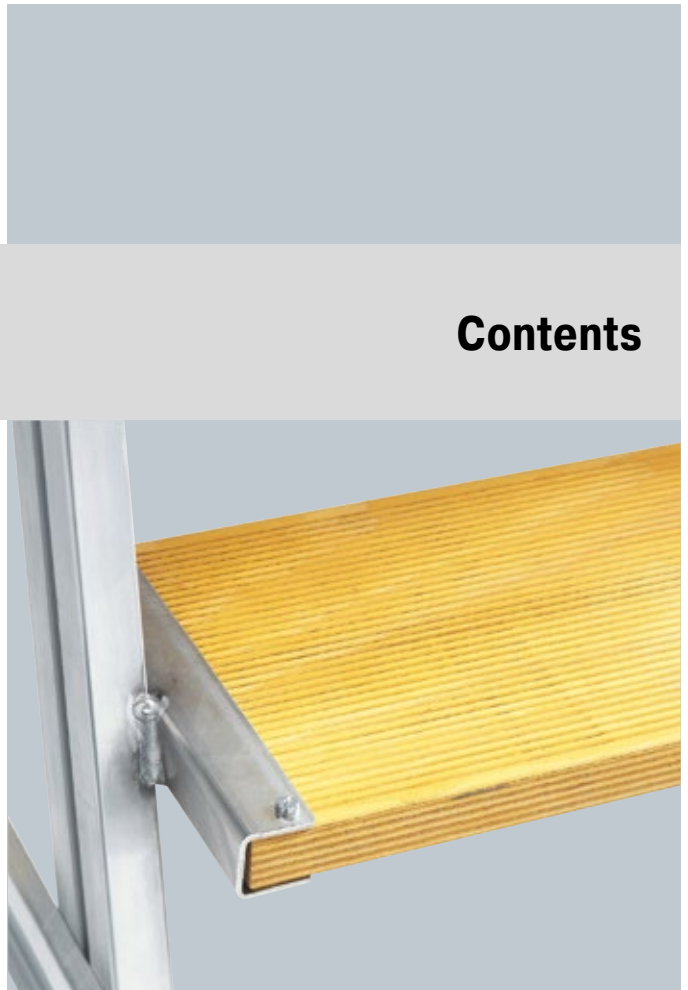



## Shelving access ladders from aluminium



- 80 mm deep treads with anti-slip ribbing and sturdy tread/stile connection
- Ideal for use with boltless shelving
- Please refer to our range of accessories to mount the ladder support railing. Support brackets must be mounted at a spacing between 0.80 and 1.30 metres.
- Distance between treads 235 mm, 20° angle
- Approved to DIN standard EN 15636 and other relevant safety regulations

STEPS & LADDERS



### Hook-on version

- Equipped with 2 pairs of hooks Ø 35 mm for hook-on fitting to the guide rail to allow a fully vertical lean-to position to the shelving when not in use
- Non-slip stile shoes
- Ladder width 420 mm

Ladder length	Number of treads incl. platform	Vertical length (push-flat position)	Access height approx.	Width at base	Post weight	Ref. no.
<i>mm</i>		<i>mm</i>	<i>mm</i>	<i>mm</i>	<i>kg</i>	
1690	6	1580	2800	580	4,3	16-13865
2190	8	2050	3300	750	6,0	16-13864
2690	10	2520	3800	920	7,4	16-13863
3190	12	2990	4300	1090	8,2	16-13862
3690	14	3460	4800	1260	9,6	16-13861
4190	16	3930	5300	1430	10,9	16-13860



### Mobile version

- Non-slip stile shoes, 2 self-locking fixed castors at the lower stile ends, castor diameter 80 mm
- Silent and smooth operation on guide rail, can be pushed flat against shelving when not in use
- Ladder width 420 mm
- Ladder width including castors 600 mm

Ladder length	Number of treads incl. platform	Vertical length (push-flat position)	Access height approx.	Width at base	Post weight	Ref. no.
<i>mm</i>		<i>mm</i>	<i>mm</i>	<i>mm</i>	<i>kg</i>	
1664	6	1920	2800	780	8,0	16-19073
2164	8	2390	3300	950	9,5	16-19074
2664	10	2860	3800	1120	11,0	16-19076
3164	12	3330	4300	1290	12,0	16-19078
3664	14	3800	4800	1460	13,5	16-19077



Folds flat



## For back-to-back shelving/racking, pivot-mounted

- Max. aisle width 1600 mm
- Castors compensate lateral spreading of up to 2 cm
- Ladder width 400 mm
- Ladder width including castors 580 mm

Ladder length	Number of treads incl. platform	Vertical length (push-flat position)	Access height approx.	Width at base	Post weight	Ref. no.
<i>mm</i>		<i>mm</i>	<i>mm</i>	<i>mm</i>	<i>kg</i>	
1780	6	2590	3440	990	18.5	16-39100
2030	7	2820	3670	1070	19.0	16-39101
2280	8	3060	3910	1160	19.5	16-39102
2530	9	3290	4140	1240	20.5	16-39103
2780	10	3530	4380	1330	21.0	16-39104
3030	11	3760	4610	1410	21.5	16-39105
3280	12	4000	4850	1500	23.0	16-39106



## Accessories



**A** Support brackets, aluminium, mounted at rail ends



**B** Support brackets, aluminium, mounted along rail length



**C** Fixing kit



**D** Ladder mounting rail, steel

Pos.	Description	Ref. no.
<b>A</b>	Support brackets, aluminium, mounted at rail ends, with left-hand stop	mounted to both ends of ladder support rail, assembly material is not included in the delivery 16-19112
	Support brackets, aluminium, mounted at rail ends, with right-hand stop	mounted to both ends of ladder support rail, assembly material is not included in the delivery 16-19113
<b>B</b>	Support brackets, aluminium, mounted along rail length	1 intermediate support bracket needed per 1 metre rail length 16-19111
<b>C</b>	Fixing kit, for steel tube rail ends and intermediate support brackets	1 fixing kit required per support bracket 16-40531
<b>D</b>	Ladder mounting rail, steel	diameter 30 mm, length 3000 mm 16-40530

## Aluminium folding steps



- 80 mm deep treads with anti-slip ribbing and sturdy tread/stile connection
- Nivello® anti-slip stile shoes provide safe footing
- Conical construction ensures high stability
- Ergo-pad® grips fitted at balance point for ergonomic carrying
- Distance between treads 235 mm, 20° angle
- Approved to DIN standard EN 15636 and other relevant safety regulations



ergo-pad® grip area



nivello® stile shoes



### Single sided access, with large working platform and tool tray

- Large working platform, size approx. 400 x 400 mm
- Tool tray integrated into railing, dimensions approx. 350 x 200 mm, folds flat
- Optimised aluminium hinges "safe-cap" provide added support, 6-point riveting and increased material thickness provide maximum stability and durability
- Conical construction ensures high stability, 2 high-strength nylon webbing straps prevent spreading
- 2 hand rails, length approx. 750 mm; self-assembly kit (railing length 1300 mm for ladders with at least 8 treads)

Access height approx.	Closed height	Height of platform/ upper tread	Width at base	Number of treads incl. platform	Weight	Ref. no.
mm	mm	mm	mm		kg	
2950	1670	950	610	4	10.3	16-39107
3150	1910	1190	640	5	11.7	16-39108
3400	2150	1420	660	6	12.6	16-39109
3650	2380	1660	690	7	13.9	16-39110
3900	2620	1890	720	8	15.8	16-39111
4100	2850	2130	750	9	17.2	16-39112
4350	3090	2360	780	10	18.4	16-39113



### Double sided access

- Sturdy aluminium hinges, bolted on 4 points, with 2 strong nylon safety straps to prevent spreading

Access height approx.	Closed height	Width at base	Number of treads incl. platform	Weight	Ref. no.
mm	mm	mm		kg	
2250	690	440	2x3	5,4	16-13847
2500	930	460	2x4	6,7	16-13846
2750	1160	490	2x5	8,0	16-13845
3000	1400	520	2x6	9,3	16-13844
3250	1630	550	2x7	10,8	16-13843
3500	1870	580	2x8	12,1	16-13842
3750	2100	610	2x9	14,3	16-13841
4000	2340	640	2x10	15,1	16-13840
4500	2790	700	2x12	18,0	16-13839
5000	3260	760	2x14	22,0	16-13838

## Aluminium folding steps

### with castors

- 80 mm deep treads with anti-slip ribbing and sturdy tread/stile connection
- Nivello® anti-slip stile shoes provide safe footing
- Conical construction ensures high stability
- Metal braces safely connect both step sides; braces can be unfastened for folding the steps
- 4 self-locking, spring-mounted castors at the lower stile ends
- Castor diameter 80 mm
- Distance between treads 235 mm, 20° angle
- Approved to DIN standard EN 15636 and other relevant safety regulations



### Single sided access, with castors

- Optimised aluminium hinges “safe-cap” provide added support, 6-point riveting and increased material thickness provide maximum stability and durability

Access height approx.	Closed height	Width at base	Number of treads incl. platform	Weight	Ref. no.
<i>mm</i>	<i>mm</i>	<i>mm</i>		<i>kg</i>	
2750	1370	620	3	8,6	16-13837
3000	1600	650	4	9,4	16-13836
3250	1830	680	5	10,5	16-13835
3500	2070	700	6	11,8	16-13834
3750	2310	740	7	13,2	16-13833
4000	2540	770	8	14,5	16-13832
4250	2760	800	9	15,7	16-13831
4500	3000	830	10	17,0	16-13830
5000	3480	890	12	19,4	16-13829
5500	3950	950	14	22,7	16-13828



### Double sided access, with castors

Access height approx.	Closed height	Width at base	Number of treads incl. platform	Weight	Ref. no.
<i>mm</i>	<i>mm</i>	<i>mm</i>		<i>kg</i>	
2250	690	590	2x3	8,1	16-13858
2500	930	610	2x4	9,5	16-13857
2750	1160	640	2x5	10,8	16-13856
3000	1400	670	2x6	12,3	16-13855
3250	1630	700	2x7	13,9	16-13854
3500	1870	730	2x8	15,3	16-13853
3750	2100	760	2x9	17,0	16-13852
4000	2340	790	2x10	18,5	16-13851
4500	2790	850	2x12	21,8	16-13850
5000	3260	910	2x14	25,6	16-13849





### Mobile aluminium platform ladders



- 80 mm deep treads with anti-slip ribbing and sturdy tread/stile connection
- Nivello® anti-slip stile shoes provide safe footing
- 2 hand rails, platform railing with knee rails
- Rear stabiliser provides added stability
- Diagonal braces can be unbolted for folding the steps and saving space when not in use
- Non-slip working platform sized approx. 510 x 600 mm with toe board on three sides
- 2 fixed castors with brake, Ø 125 mm
- Distance between treads 235 mm, 20° angle
- Approved to DIN standard EN 15636 and other relevant safety regulations



nivello® stile shoes

#### Single sided access

Access height approx.	Closed height	Height of platform/ upper tread	Width at base	Open width (distance rack/ ladder base)	Number of treads incl. platform	Weight	Ref. no.
<i>mm</i>	<i>mm</i>	<i>mm</i>	<i>mm</i>	<i>mm</i>		<i>kg</i>	
3850	2850	1850	1200	1460	8	45.5	16-39114
4100	3100	2080	1200	1570	9	49.5	16-39115
4600	3600	2560	1460	1780	11	54.0	16-39116



## Mobile aluminium access ladders

### folding version

- Sturdy stiles
- 80 mm deep treads with anti-slip ribbing and sturdy tread/stile connection
- Large platform sized 650 x 600 mm with non-slip aluminium surface
- Twin handrails
- Platform railing on three sides
- Nivello® anti-slip stile shoes provide safe footing
- Large tool tray on upper guard railing
- Ladder width 650 mm
- Approved to DIN standard EN 15636 and other relevant safety regulations



Folds flat



nivello® stile shoes

### Folding version

- Stabiliser with two braked fixed castors Ø 125 mm

Access height approx.	Height of platform/ upper tread	Height incl. railing	Ladder length closed	Number of treads incl. platform	Weight	Ref. no.
mm	mm	mm	mm		kg	
3150	1150	2150	2750	5	37	16-39132
3400	1380	2380	3000	6	39	16-39133
3600	1610	2610	3250	7	43	16-39134
3850	1840	2840	3500	8	45	16-39135
4300	2300	3300	4000	10	49	16-39136
4800	2770	3770	4500	12	55	16-39137
5250	3230	4230	5000	14	76	16-39138



### Folding version, narrow width stabiliser

- 2 braked fixed castors Ø 125 mm
- Small width stabiliser for use in particularly narrow aisles
- Weight balancers provide required operational safety, delivery includes assembly instructions

Access height approx.	Height of platform/ upper tread	Height incl. railing	Ladder length closed	Number of treads incl. platform	Weight	Ref. no.
mm	mm	mm	mm		kg	
3150	1150	2150	2750	5	67	16-39139
3400	1380	2380	3000	6	89	16-39140
3600	1610	2610	3250	7	103	16-39141
3850	1840	2840	3500	8	125	16-39142
4300	2300	3300	4000	10	149	16-39143
4800	2770	3770	4500	12	205	16-39144
5250	3230	4230	5000	14	218	16-39145



### Mobile access platforms platform height up to 2 metres



- Sturdy box section aluminium stiles
- Guardrail on 3 sides includes knee rail and toeboards
- Supplied unmounted, detailed instructions are included
- 4 self-locking swivel castors (2 with brake), Ø 125 mm
- Tread depth 200 mm
- Platform size 600 x 800 mm
- Hand railing on both sides is optional according to DIN EN131-7 if the incline does not exceed 60°
- Approved to DIN standard EN 15636 and other relevant safety regulations

STEPS & LADDERS



#### Single sided access, treads and platform from aluminium with non-slip diamond pattern surface

- Aluminium treads and platform with non-slip ribbed surface
- Please note: Delivery does not include hand railing

Access height approx.	Platform height without railing	Dimensions at base W x D	Number of treads incl. platform	Weight	Ref. no.
<i>mm</i>	<i>mm</i>	<i>mm</i>		<i>kg</i>	
2700	720	770 x 1240	3	30	16-39146
3000	960	820 x 1410	4	32	16-39147
3200	1200	880 x 1580	5	35	16-39148
3500	1440	940 x 1750	6	38	16-39149
3700	1680	1000 x 1920	7	43	16-39150
3900	1920	1060 x 2090	8	47	16-39151



#### Double sided access, treads and platform from aluminium with non-slip diamond pattern surface

- Aluminium treads and platform with non-slip ribbed surface
- Please note: Delivery does not include hand railing

Access height approx.	Platform height without railing	Dimensions at base W x D	Number of treads incl. platform	Weight	Ref. no.
<i>mm</i>	<i>mm</i>	<i>mm</i>		<i>kg</i>	
2700	720	770 x 1510	3	30	16-39155
3000	960	820 x 1790	4	34	16-39156
3200	1200	880 x 2070	5	39	16-39157
3500	1440	940 x 2350	6	44	16-39158
3700	1680	1000 x 2620	7	49	16-39159
3900	1920	1060 x 2900	8	55	16-39160

Accessories



**A** Handrails for single sided access



**B** Handrails for double sided access

Pos.	Description	Ref. no.
<b>A</b>	Handrails for single sided access, left and right hand doors as required	suited for access platforms with 3 treads
		suited for access platforms with 4-6 treads
		suited for access platforms with 7-8 treads
<b>B</b>	Handrails for double sided access	suited for access platforms with 3 treads
		suited for access platforms with 4-6 treads
		suited for access platforms with 7-8 treads





## Mobile aluminium access platforms

platform height up to 4 metres



- Supplied with twin hand rails and platform with three-sided guard railing, railing height 1100 mm
- All steps and ladders comply with the latest safety regulations in Germany and with the European standard DIN EN ISO 14122
- Rear stabiliser with 2 fixed castors, Ø 160 mm
- All castors with TOTALSTOP brake
- 2 swivel castors, Ø 125 mm, fitted to mounting side
- Platform depth 600 mm



### 60° incline

- Tread width 800 mm
- Tread depth 200 mm

Height of platform/upper tread <i>mm</i>	Width at base <i>mm</i>	Number of treads incl. platform	Ref. no.
1690	1630	7	16-39177
1940	1780	8	16-39178
2180	1920	9	16-39179
2420	2040	10	16-39180
2660	2170	11	16-39181
2900	2320	12	16-39182
3150	2460	13	16-39183
3400	2600	14	16-39184
3640	2740	15	16-39185
3880	2880	16	16-39186



### 45° incline

- Tread width 800 mm
- Tread depth 240 mm

Height of platform/upper tread <i>mm</i>	Width at base <i>mm</i>	Number of treads incl. platform	Ref. no.
1670	2250	8	16-39165
1870	2450	9	16-39166
2080	2630	10	16-39167
2290	2840	11	16-39168
2500	3050	12	16-39169
2700	3250	13	16-39170
2910	3460	14	16-39171
3120	3670	15	16-39172
3330	3880	16	16-39173
3540	4090	17	16-39174
3750	4300	18	16-39175
3950	4500	19	16-39176

## Aluminium folding steps

- Folds flat in a second
- Heavy duty twin stiles
- Anti-slip treads sized 205 x 360 mm
- Non-slip stile shoes
- Approved to DIN standard EN 15636 and other relevant safety regulations



Folds flat



## Without push bar

- Depth when folded 85 mm

Access height approx.	Height of top tread	Total width	Number of treads incl. platform	Weight	Ref. no.
<i>mm</i>	<i>mm</i>	<i>mm</i>		<i>kg</i>	
2400	420	550	2	5.0	16-39117
2700	640	570	3	7.0	16-39118



## With folding handle and tool tray

- Depth when folded 125 mm

Access height approx.	Height of top tread	Total width	Number of treads incl. platform	Weight	Ref. no.
<i>mm</i>	<i>mm</i>	<i>mm</i>		<i>kg</i>	
2700	640	550	3	9.0	16-39119
2900	860	570	4	11.5	16-39120
3100	1060	590	5	13.5	16-39121



## Aluminium platform steps

- Heavy duty aluminium construction
- Aluminium treads and platform with non-slip ribbed surface
- Approved to DIN standard EN 15636 and other relevant safety regulations



### Single sided access

- Sturdy welded construction from tubular aluminium profiles
- Non-slip plastic stile shoes
- Large uppermost tread sized 410 x 300 mm for comfortable and safe working
- Supplied unmounted, detailed instructions are included



Access height approx. <i>mm</i>	Platform height <i>mm</i>	Dimensions upper tread W x H <i>mm</i>	Dimensions at base W x D <i>mm</i>	Number of treads incl. platform	Weight <i>kg</i>	Ref. no.
2500	490	410 x 300	540 x 530	2	5.30	16-39122
2700	730	410 x 300	590 x 770	3	7.90	16-39123
3000	970	410 x 300	640 x 1000	4	10.50	16-39124

### Single sided access, folding version

- Heavy duty aluminium box section stiles
- Nivello® anti-slip stile shoes provide safe footing
- Platform steps can be folded for storage
- 80 mm deep treads with non-slip surface
- Aluminium platform with anti-slip diamond pattern surface



Access height approx. <i>mm</i>	Platform height <i>mm</i>	Dimensions upper tread W x H <i>mm</i>	Dimensions at base W x D <i>mm</i>	Number of treads incl. platform	Weight <i>kg</i>	Ref. no.
2700	720	650 x 300	760 x 800	3	7.50	16-39127
3000	960	650 x 300	920 x 830	4	8.90	16-39128

### Double sided access, folding version

- Heavy duty aluminium box section stiles
- Non-slip plastic stile shoes
- Platform steps can be folded for storage
- 80 mm deep treads with non-slip surface
- Aluminium platform with anti-slip diamond pattern surface



Access height approx. <i>mm</i>	Platform height <i>mm</i>	Dimensions upper tread W x H <i>mm</i>	Dimensions at base W x D <i>mm</i>	Number of treads incl. platform	Weight <i>kg</i>	Ref. no.
2460	460	520 x 330	620 x 560	2x2	4.70	16-39129
2690	690	520 x 330	790 x 590	2x3	6.10	16-39130
2930	930	520 x 330	960 x 620	2x4	7.70	16-39131

## Kick steps

- From grey PVC, with 3 braked castors
- Can be moved to any place with a slight push
- Castors retract and lock in place when weight is applied

Diameter at top	Diameter at base	Closed height	Overall height (with support stand fitted)	Load capacity	Ref. no.
<i>mm</i>	<i>mm</i>	<i>mm</i>	<i>mm</i>	<i>kg</i>	
300	450	435	430	150	16-11590



## Step stools

- 150 mm deep glazed treads
- Platform with grip hole
- Stiles from epoxy-coated steel in grey, RAL 7023
- Non-slip stile shoes
- Approved to DIN standard EN 15636 and other relevant safety regulations



## Without castors

Access height approx.	Number of treads incl. platform	Closed height	Dimensions at base W x D	Ref. no.
<i>mm</i>		<i>mm</i>	<i>mm</i>	
2400	2	490	460 x 620	16-19104
2600	3	730	500 x 820	16-19105
2800	4	970	540 x 1000	16-19106



## With castors

- 4 braked castors for on-site fitting
- Castor orientation allows forward and reverse movement and lock in place as soon as weight is applied

Access height approx.	Number of treads incl. platform	Closed height	Dimensions at base W x D	Ref. no.
<i>mm</i>		<i>mm</i>	<i>mm</i>	
2400	2	490	460 x 620	16-19107
2600	3	730	500 x 820	16-19108
2800	4	970	540 x 1000	16-19109







**Smart solutions to protect our environment!**

ENVIRONMENTAL PROTECTION



Environmentally hazardous substances such as oils, acids, paints, etc. require environmentally sound storage solutions! The BITO product range caters for these needs with various products such as drum racking, spill trays and tapping stations as well as with complete solutions such as spill deck systems and boltless shelving standing in a spill tray to provide safe storage of kegs and cans containing hazardous liquids. Of course, our multi-purpose container series MB also offers a “green” option.

Pick your solution from the following pages! For further questions, call our hotline number below!



**Contents**

**Drum racking .....260**

**Spill trays ..... 261**

**Spill prevention systems .....262**

**Drum pallets .....263**

**Containers for hazardous substances..... 264**

**Containment shelving .....265**



## Drum racking

for 4 drums with a 200 litre capacity, with spill tray

- Safe and environmentally friendly storage of oil, grease and acids
- Suited for horizontal storage of 4 x 200 litre drums
- Drum cradles allow convenient and precise drum positioning
- Supplied with bucket/can holder
- Spill tray with TÜV certificate of conformity
- Spill tray from 3 mm thick steel sheet according to DIN 10025, supplied with certificate of conformity (ÜHP) for compliance with above-standard safety regulations



Width of starter bay  
1960 mm

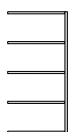

Width of extension bay  
1880 mm

**TOP SELLER**!

66-33111

Dimensions H x W x D	Description	Ref. no.
<i>mm</i>		
2000 x 1960 x 800	Starter bay	66-33111
2000 x 1880 x 800	Extension bay	66-33112

### Accessories



**A** Drum supports



**B** Bucket/can holders



**C** Beams

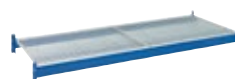

**D** Level decking options to fit BITO-TwinTop® beams

Pos.	Description	Colour	Dimensions	Ref. no.
			<i>mm</i>	
<b>A</b>	Drum supports	RAL 5010 Gentian blue	L 270 x H 210 x D 800	66-18103
<b>B</b>	Bucket/can holders	RAL 5010 Gentian blue	L 330 x H 347 x D 230	66-18104
<b>C</b>	Beams	RAL 5010 Gentian blue	L 1800 x H 95	66-23656
<b>D</b>	Level decking options to fit BITO-TwinTop® beams - 1 segment	galvanised	L 1800 x W 800 D 800	66-40871



## Drum racking

for drum storage on pallets

- Shelf load: 3000 kg
- Safe and environmentally friendly storage of oil, grease and acids
- Suited for vertical drum storage
- Spill tray with TÜV certificate of conformity
- Spill tray from 3 mm thick steel sheet approved to DIN 10025, retaining capacity 415 litres, supplied with certificate of conformity (ÜHP) for compliance with above-standard safety regulations
- Load capacity per level 3000 kg maximum
- Frames and spill tray galvanised, beams epoxy-coated in gentian blue RAL 5010
- Further bays can be added whenever required



Width of starter bay  
2860 mm

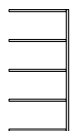

Width of extension bay  
2780 mm

Dimensions H x W x D <i>mm</i>	Description	Ref. no.
2500 x 2860 x 1100	Starter bay	66-26666
2500 x 2780 x 1100	Extension bay	66-26667

## Spill trays

- From 3 mm thick steel sheet approved to DIN EN 10327, sealed to prevent leakage, with certificate of conformity for above-standard quality
- Fork shoe height 100 mm for safe lift truck handling



### **i** BITO info

**Please note:** The spill tray must hold at least 10% of the total storage volume or at least the entire content of the largest container.

**Exception:** In water protection areas the spill tray must hold 100% of the contents.

External dimensions W x H x D <i>mm</i>	Spill tray volume <i>litres</i>	Description	Ref. no.
1700 x 251 x 1290	269	without mesh deck	66-33110
2600 x 260 x 1290	415	without mesh deck	66-9608
		with grating deck (can be removed)	66-9611







## Spill prevention systems



ENVIRONMENTAL PROTECTION

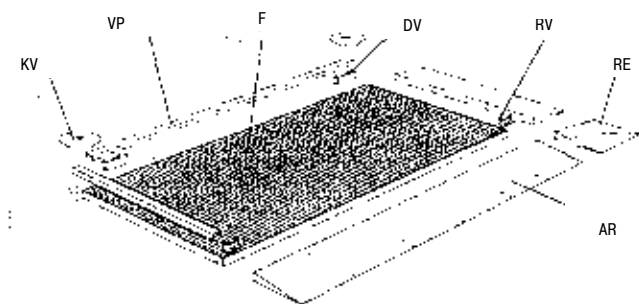

- Approved for highly flammable liquids
- Modular system allows future expansion and modification
- Availability of spill deck modules in various dimensions allows optimum adaptation to your operational requirements
- Load capacity 5000 kg/m<sup>2</sup>, maximum wheel load 450 kg
- Easy assembly, unlimited range of applications
- Spill decks can also be supplied with increased load capacity for lift truck and lorry traffic
- Catchment sump from 3 mm thick steel sheet, galvanised, with removable mesh deck
- Individual solutions can be realised upon request (f. ex. for increased load capacity)
- Spill deck modules and accessories are galvanised

### Spill deck modules, standard version

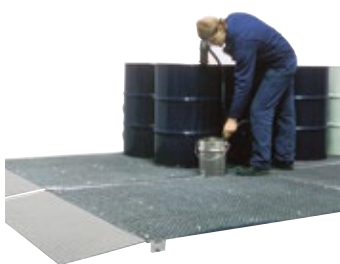

Dimensions L x H x D <i>mm</i>	Spill tray volume <i>litres</i>	Ref. no.
1362 x 78 x 1362	80	24-12943
1862 x 78 x 1362	110	24-12944
2862 x 78 x 1362	170	24-12945
2862 x 78 x 1862	229	24-12946



### Ramp edges

Description	Dimensions L x W <i>mm</i>	Ref. no.
Ramp side profiles	1320 x 720	24-12950
	1820 x 720	24-12951
	2820 x 720	24-12952
Ramp edges	730 x 730	24-12953



### Fixing elements

Description	Dimensions L x W <i>mm</i>	Ref. no.
Distance holders	25 x 120	24-12954
Edge clamps	20 x 100	24-12955
Four way clamp	130 x 130	24-12956
T-profiles to join the sides of spill deck modules	1320 x 45	24-12947
	1820 x 45	24-12948
	2820 x 45	24-12949

**Drum pallets**

- Approved for highly flammable liquids
- Removable hot-dip galvanised mesh deck
- With fork shoes for safe handling with a forklift truck
- Retaining volume is equivalent to 1 drum with a 200 litre content
- Spill tray from 3 mm thick steel sheet according to DIN 10025, supplied with certificate of conformity (ÜHP) for compliance with above-standard safety regulations

**TOP SELLER!**  
24-11406



ENVIRONMENTAL PROTECTION

	External dimensions L x D x H <i>mm</i>	Height of fork shoes/runners <i>mm</i>	Description	colour	RAL 5010 Gentian blue	galvanised
				Spill tray volume <i>litres</i>	Ref. no.	Ref. no.
	1236 x 816 x 328 mm	90	2 drums in 1 row	208	24-12915	24-11406
	1290 x 1211 x 250 mm		4 drums in 2 rows	200	24-12917	24-12918
	2460 x 816 x 233 mm	100	4 drums in 1 row	210	24-12914	24-12916
	2460 x 1211 x 210 mm		8 drums in 2 rows	205	24-12919	24-12920

### Containers for hazardous substances

Safe transport of hazardous goods such as paints, sprays, etc.

- Consisting of container and drop-over lid
- Tightly closing lid with ready-mounted metal lever locks
- MB containers have been approved by the BAM Federal Institute for Materials Research and Testing as outer packaging for hazardous goods categorised into packaging groups II and III. The certificate of approval bears the number 4H2/Y25/S/23/D/BAM6107-BITO. MB containers conform to the German regulations on the transport of hazardous substances by road (GGVS), by rail (GGVE), by sea (GGVSee) and by air.

BITO-Plus



See our multi-purpose container range from page 82

External dimensions L x W <i>mm</i>	Height <i>mm</i>	Volume <i>litres</i>	Load capacity <i>kg</i>	Bin type	Colour	Ref. no.
410 x 310	238	18	13	MBSG43221CLIP	purple red	6-18653
	338	27	13	MBSG43321CLIP	purple red	6-18655
610 x 410	238	38	17	MBSG64221CLIP	purple red	6-18657
	338	58	20	MBSG64321CLIP	purple red	6-18659
	438	74	20	MBSG64421CLIP	purple red	6-18660



## Containment shelving

- Shelf levels are adjustable on a 25 mm pitch
- All parts are galvanised
- Extensions possible at any time

### **i** BITO info

All shelving units can be equipped with solid shelves, wire shelves or tray shelves. All shelf types can also be combined in the same unit.

### With tray shelves

- Supplied with 5 tray shelves with liquid-tight seams
- 60 mm deep tray shelves, upper edge folded to prevent injuries

Shelf load	Dimensions H x W x D	Description	Ref. no.
<i>kg</i>	<i>mm</i>		
200	2000 x 1058 x 524	Starter bay	10-53089
	2000 x 1008 x 524	Extension bay	10-53090

### With shelves and spill tray

- Supplied with 5 shelves and a spill tray
- Reliable soil protection, as spill tray is large enough to accommodate entire shelving
- Approved for highly flammable liquids
- 83 mm deep tray shelves, retention volume 30 litres

Shelf load	Dimensions H x W x D	Spill tray dimensions H x W x D	Description	Ref. no.
<i>kg</i>	<i>mm</i>	<i>mm</i>		
200	2000 x 1058 x 524	83 x 1096 x 570	Starter bay	10-53093
200	2000 x 1008 x 524	83 x 1005 x 570	Extension bay	10-53094

### With wire shelves and spill tray

- Supplied with 5 wire shelves and a spill tray
- Reliable soil protection, as spill tray is large enough to accommodate entire shelving
- Approved for highly flammable liquids
- 83 mm deep tray shelves, retention volume 30 litres

Shelf load	Dimensions H x W x D	Spill tray dimensions H x W x D	Description	Ref. no.
<i>kg</i>	<i>mm</i>	<i>mm</i>		
100	2000 x 1058 x 524	83 x 1096 x 570	Starter bay	10-53091
100	2000 x 1008 x 524	83 x 1005 x 570	Extension bay	10-53092



### Accessories



**A** Additional shelves



**B** Tray shelves



**C** Wire shelves

Pos.	Description	Ref. no.
<b>A</b>	Shelf, 40 mm high set includes 4 shelf clips, shelf height 40 mm, with shelf perforations for dividers	10-17076
<b>B</b>	Tray shelves safe storage of receptacles with spill potential such as open paint cans etc., shelves retain spillage, height 60 mm, supplied with 4 shelf clips, shelf load capacity 200 kg, all loads indicated refer to uniformly distributed loads	10-12937
<b>C</b>	Wire shelves shelf height 25 mm, mesh rods with 30 mm spacing, supplied with 4 shelf clips, load capacity per wire shelf 100 kg, all loads indicated refer to uniformly distributed loads	10-16489





**Stay safe and well organised!**



Optimise your logistic processes and protect your warehouse and workshop facilities as well as your staff while complying with the latest regulations set up by health and safety at work acts as well as accident prevention and insurance associations. Take a look at our barriers and bumpers to prevent collision damage, accidents and resulting idle times.

Our useful range of products also includes high-quality line marking paint and marking tapes to highlight in-house traffic routes and hazard areas as is required by the latest regulations.

Also consider our selection of signs and labels for easy and immediate product location and identification!



Contents

- Spray paint marking ..... 268
- Edge and corner buffering ..... 270
- Traffic and pedestrian control ..... 272
- Flexible impact barriers ..... 274
- Flexible upright protectors ..... 278
- Impact protection barriers ..... 279
- Shelving & racking protection ..... 281
- Rack end barrier ..... 282
- Security mirrors ..... 283
- Display systems ..... 284
- Document pockets ..... 287
- Stock identification signs ..... 290
- Labels ..... 291
- Label holders ..... 293



IDENTIFICATION & SAFETY

**Spray paint marking**



**Line marking paint**

- Quick-drying
- Abrasion-resistant
- CFC-free
- For delineating shelving and racking areas, pallet deposit areas, in-house traffic routes, etc.
- Compliance with the latest regulations of accident prevention and insurance associations and national health and safety at work acts
- Spray line width 50 mm, sufficient for approx. 75-90 m
- Drying time approx. 24 hours
- Resistant to petrol, oil, lubricants and most chemicals
- Suited for most surfaces
- The application surface should be free of soil, oils, chemicals and paint residues

Can content	Colour	Ref. no.
<i>ml</i>		
750	yellow	46-20700
	white	46-20701
	orange	46-20702
	black	46-20703
	grey	46-20704
	blue	46-20705
	red	46-20706
	green	46-20707



**Line marking applicators**

- 4-wheeled applicator providing greater stability for straight long lines; rear wheels can be removed
- 2-wheeled application of curved lines close to and around shelving and racking, deposit areas, pallet stacks etc.
- Material steel tube
- Colour blue

Line width	Ref. no.
<i>mm</i>	
50-75	46-20709
100-130	46-20710



### Self-adhesive hazard warning tape

- Highlight hazard areas and obstacles in your warehouse as is required by the latest health and safety regulations
- Clear marking of hazard areas and obstacles provides increased operational safety
- Can be manually applied or with a tape dispenser
- Material vinyl

Material thickness <i>μ</i>	Length <i>m</i>	Width <i>mm</i>	Colour	Ref. no.
33	66	60	yellow & black	46-20820
			red/white	46-20821
170	33	50	yellow & black	46-20812
			red/white	46-20813
		75	yellow & black	46-20814
			red/white	46-20815



### Marking tapes

- For short-term and medium-term marking
- Can be removed without residue
- Optimum application temperature at least 10°C
- The application surface must be dry and free of grease and dust
- Can be manually applied or with a tape dispenser
- Material vinyl

Material thickness <i>μ</i>	Length <i>m</i>	Width <i>mm</i>	Colour	Ref. no.
150	33	50	yellow	46-20800
			white	46-20801
			orange	46-20802
			blue	46-20803
			red	46-20804
			green	46-20805
		75	yellow	46-20806
			white	46-20807
			orange	46-20808
			blue	46-20809
			red	46-20810
		green	46-20811	



### Marking tape dispensers

Description	Ref. no.
for spray line widths between 50 and 75 mm	46-20816





### Edge and corner buffering



- Temperature resistant from -40 to +100 °C
- Compliance with fire protection regulation DIN 4102 B2
- Signal colouring in compliance with DIN 4844
- For indoor and outdoor use
- Age-resistant
- Can be cut to required length with a sharp knife

#### **i** BITO info

Increase warehouse safety by highlighting spots of potential personnel injury or equipment damage.



IDENTIFICATION & SAFETY



#### Shock absorbing bumpers

- Suited for heavy duty applications
- Highly shock-absorbent
- For light duty applications
- Suited for areas with automated operations
- Self-adhesive
- Can also be bolted to carrier
- Material polyurethane
- Colour yellow & black

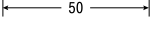

Dimensions <i>mm</i>	Description	Width / Side length <i>mm</i>	Material thickness <i>mm</i>	Ref. no.
	Flat shaped profile, supplied in lengths of 1 m	50	20	46-20501
	Flat shaped profile, 5 metre roll	50	20	46-20502
	Angled profile, supplied in lengths of 1 m	47 x 47	12	46-20503
	Angled profile, 5 metre roll	47 x 47	12	46-20504

### Edge buffering

- Protects personnel from injury
- Shock-absorbent
- Ideal for areas with manual operations
- For light duty applications
- Material polyurethane
- Colour yellow & black



Dimensions <i>mm</i>	Description	Ref. no.
	supplied in lengths of 1 m, self-adhesive, flat underside	46-20505
	5 metre roll, self-adhesive, flat underside	46-20506
	supplied in lengths of 1 m, self-adhesive, angled underside	46-20507
	5 metre roll, self-adhesive, angled underside	46-20508
	supplied in lengths of 1 m, push-on fitting, grooved underside	46-20511
	5 metre roll, push-on fitting, grooved underside	46-20512

### Corner buffering

- Angled underside
- Self-adhesive
- Material polyurethane
- Colour black



Description	Ref. no.
bi-directional	46-20509
tri-directional	46-20510

### Pipework buffering

- For pipes, cable ducts and hoses
- Self-adhesive
- Additional fixing with brackets possible
- Material polyurethane
- Colour yellow & black



Dimensions <i>mm</i>	Description	Suited for tube diameters of <i>mm</i>	Ref. no.
	supplied in lengths of 1 m	20 - 40	46-20513
		40 - 70	46-20515



### Traffic and pedestrian control

**TOP SELLER!**

46-20765





Fences in hazard zones

#### Post and chain kits

- 6 posts per kit
- Supplied with 5 plastic chains, each 3 m long
- Increased operational safety
- Manufactured from high grade PVC for excellent wear and tear resistance
- Can also be used separately

Post height <i>mm</i>	Post weight <i>kg</i>	Post base dimensions <i>mm</i>	Description	Ref. no.
1000	4.2	370 x 75	red with white reflector stripes	46-20765
			yellow with black stripes	46-20764

#### Accessories

Description	Description	Dimensions <i>mm</i>	Ø foot <i>mm</i>	Ref. no.
 Chain posts	M36 thread for mounting threaded eye bolts or signs, supplied with eye bolt, Material polypropylene	red with reflector stripes	H 1000 400	46-40171
		yellow with 2 black stripes	H 1000 400	46-40172



#### Flexi-posts, black with reflective yellow stripes

- Protects equipment, vehicles and staff against collision damage
- Post bends upon impact and rebounds to original position
- Flexible, yet extremely durable
- Please order fixings separately
- Material polyurethane
- Colour yellow & black



Height <i>mm</i>	Ø foot <i>mm</i>	Ø Post <i>mm</i>	Colour	Ref. no.
300	200	80	yellow & black	46-40163
450	200	80	yellow & black	46-40162
750	200	80	yellow & black	46-40161
1000	200	80	yellow & black	46-40160

#### Accessories

Description	Description	Description	Ref. no.
 Adapters	M36 thread for mounting threaded eye bolts or signs, Material polypropylene, colour black	for flexi-posts	46-40166
 Floor anchor set	supplied with 3 floor anchors Ø 18 mm with hex head lag screws	for flexi-posts	46-40164
 Threaded eye bolts	M36 thread for chain post mounting, ideal for guiding barrier chains, ropes and tapes, Material polypropylene, colour black	for flexi-posts	46-40165

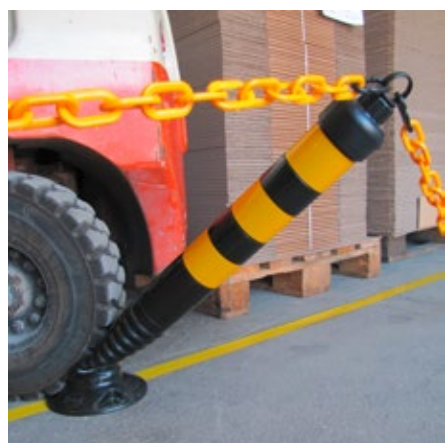

**Accessories for post and chain kits and for flexi-posts**

Pos.	Description		Description	Dimensions <i>mm</i>	Ref. no.
A	Plastic chains	link chain posts to each other, Material polypropylene, colour yellow & black	with 2 chain links	L 3000	46-40175
			without chain links	L 25000	46-40177
		link chain posts to each other, Material polypropylene, colour red/white	with 2 chain links	L 3000	46-40174
			without chain links	L 25000	46-40176
B	Chain links	allow hook-in fitting of chains/chain links, Material polypropylene, colour black	for plastic chains	-	46-40173
C	Post mounted signs	connector piece with M36 thread for chain post mounting, Material polypropylene	triangular sign	L 390	46-40180
			round sign	Ø 280	46-40183
			round sign	Ø 380	46-40182
			rectangular sign	W 350 x H 410	46-40181



**Belt barrier posts, plastic**

- Practical and sturdy barrier and guiding system
- Speedy solution for cordoning off walkways and areas with restricted access or when organising pedestrian queues
- Suitable for use in industry, storage areas, car parks, open areas etc.
- Stores away when not in use: simply remove post from its domed foot. Ready for instant re-use by pulling out the tape from its cartridge and hooking it to the next post. The centrifugal belt-braking system prevents belt from retracting too quickly.
- Cartridge and domed foot from plastic; foot can be weighted with sand or gravel for greater stability, for indoor and outdoor use

Height	Ø Post	Ø foot	Belt length	Belt width	Colour	Ref. no.
<i>mm</i>	<i>mm</i>	<i>mm</i>	<i>m</i>	<i>mm</i>		
950	50	360	3	50	red/white	46-53502
					yellow & black	46-53503



**Accessories**

Pos.	Description		Dimensions <i>mm</i>	Ref. no.
A	Wall receiver clip, bolt-on fixing	easy-to-mount wall clip from tough plastic for plug-in belt fixing, colour black	L 50 x H 88 x D 12 mm	46-53512
B	Wall receiver clip, with magnetic backing	wall clip for magnetic belt fixing, allow to rope off a doorway or an area by linking two opposite walls, colour black	L 50 x H 88 x D 12 mm	46-53513

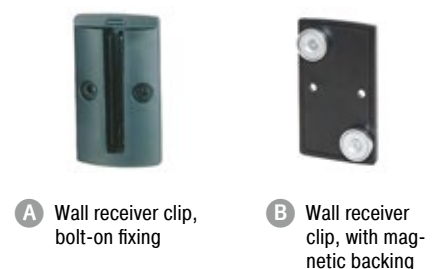





### Flexible impact barriers



- **Manufactured from flexible plastic**
- **Yields when there is a collision, absorbs impact forces and returns to original upright position**
- **Impact absorption prevents damage to barriers, vehicles and floor, reducing maintenance and repair, eliminating downtime**
- **Yellow/black signal striping guarantees high visual impact**
- **For outdoor and indoor use**
- **Easy to install, supplied with fixing material**

#### **i BITO info**

##### **Modular construction provides great flexibility!**

Adapt this system to your requirements by choosing posts and guard rail sets.  
Total length = 1x post diameter + number of guard rail sets

#### **Flexible safety railing**

- Persons in your premises are safely channeled in the right direction
- Tested to withstand a static load of 2 kN
- Corresponds to the weight of two persons leaning against the safety barrier, ~ 200 kg
- Colour yellow & black

Description	Height <i>mm</i>	Length <i>mm</i>	Base plate <i>mm</i>	Diameter <i>mm</i>	Impact area <i>mm</i>	Ref. no.
Line end post and in-line post	1181		180 x 180	130	233 - 1.100	46-52788
Corner post 90°	1181		180 x 180	130	233 - 1.100	46-52789
Set of horizontal profiles	100	500			233 - 1.100	46-52790
	100	1000			233 - 1.100	46-52791
	100	1500			233 - 1.100	46-52792
	100	2000			233 - 1.100	46-52793

#### **Flexible pedestrian guard railing**

- Separates walkways from trafficways, secures operations
- Allow the replacement of posts and guard rails without having to dismantle an adjacent section of the barrier
- Patented connection technology: a special energy-absorbing coupling system provides increased protection
- Tested to withstand an impact of 11,600 joules
- Equals 4.6 t at 8 km/h at an impact angle of 45°
- Colour yellow & black

Description	Height <i>mm</i>	Length <i>mm</i>	Base plate <i>mm</i>	Diameter <i>mm</i>	Impact area <i>mm</i>	Ref. no.
Line end post	1136		180 x 180	130	450 - 1.100	46-52794
In-line post	1136		180 x 180	130	450 - 1.100	46-52795
Corner post 90°	1136		180 x 180	130	450 - 1.100	46-52796
Set of horizontal profiles		600		100	450 - 1.100	46-52797
		1000		100	450 - 1.100	46-52798
		1600		100	450 - 1.100	46-52799
		2000		100	450 - 1.100	46-52800





- **Manufactured from flexible plastic**
- **Yields when there is a collision, absorbs impact forces and returns to original upright position**
- **Impact absorption prevents damage to barriers, vehicles and floor, reducing maintenance and repair, eliminating downtime**
- **Yellow/black signal striping guarantees high visual impact**
- **For outdoor and indoor use**
- **Easy to install, supplied with fixing material**

## **i** BITO info

### **Modular construction provides great flexibility!**

Adapt this system to your requirements by choosing posts and guard rail sets.  
 Total length = 1x post diameter + number of guard rail sets

## Flexible traffic railing

- Protects machinery and buildings against collision damage
- Allow the replacement of posts and guard rails without having to dismantle an adjacent section of the barrier
- Patented connection technology: a special energy-absorbing coupling system provides increased protection
- Tested to withstand an impact of 20,400 joules
- Equals 5.3 t at 10 km/h at an impact angle of 45°
- Colour yellow & black



Description	Height <i>mm</i>	Length <i>mm</i>	Base plate <i>mm</i>	Diameter <i>mm</i>	Impact area <i>mm</i>	Ref. no.
Line end post	456		180 x 180	158	204 - 362	46-52801
In-line post	456		180 x 180	158	204 - 362	46-52802
Corner post 90°	456		180 x 180	158	204 - 362	46-52803
Set of horizontal profiles		500		158	204 - 362	46-52804
		1000		158	204 - 362	46-52805
		1500		158	204 - 362	46-52806
		2000		158	204 - 362	46-52807

## Flexible traffic railing “Plus”

- Protects staff, machinery and buildings against collision damage from service vehicles; dual function: **can be used to separate walkways from trafficways and as impact barrier**
- Allow the replacement of posts and guard rails without having to dismantle an adjacent section of the barrier
- Patented connection technology: a special energy-absorbing coupling system provides increased protection
- Tested to withstand an impact of 20,400 joules
- Equals 5.3 t at 10 km/h at an impact angle of 45°
- Colour yellow & black



Description	Height <i>mm</i>	Length <i>mm</i>	Base plate <i>mm</i>	Diameter <i>mm</i>	Impact area <i>mm</i>	Ref. no.
Line end post	1185		180 x 180	158	204 - 362	46-52808
In-line post	1185		180 x 180	158	204 - 362	46-52809
Corner post 90°	1185		180 x 180	158	204 - 362	46-52810
Set of horizontal profiles		500		158 / 100 x 35	204 - 362	46-52811
		1000		158 / 100 x 35	204 - 362	46-52812
		1500		158 / 100 x 35	204 - 362	46-52813
		2000		158 / 100 x 35	204 - 362	46-52814



### Flexible impact barriers



#### Flexible bollards

- Manufactured from flexible plastic
- Yields when there is a collision, absorbs impact forces and returns to original upright position
- Impact absorption prevents damage to barriers, vehicles and floor, reducing maintenance and repair, eliminating downtime
- Yellow/black signal striping guarantees high visual impact
- For outdoor and indoor use
- Easy to install, supplied with fixing material
- Protects racking, machinery and buildings against collision damage
- Tested to withstand an impact of 6,900 joules
- Equals 5 t at 6 km/h at an impact angle of 90°
- Colour yellow & black

Height <i>mm</i>	Base plate <i>mm</i>	Diameter <i>mm</i>	Impact area <i>mm</i>	Ref. no.
835	230 x 230	190	750	46-52786
1200	230 x 230	190	1200	46-52787

#### Flexible column and pole protectors

- Manufactured from flexible plastic
- Protect square and rectangular columns
- Stackable and interlocking modular elements allow individual height adjustment
- Special rib structure absorbs impact energy and prevents dangerous damage to columns
- The modular column protection system consists of yellow corner elements and optional black spacers to ensure perfect adaption to column dimensions
- For outdoor and indoor use
- Fast and easy assembly without bolts
- Secures pillars and posts against collision damage
- Tested to withstand an impact of 1,600 joules
- Equals 1.8 t at 3 km/h at an impact angle of 90°
- Colour yellow



Description	Height <i>mm</i>	Length <i>mm</i>	Post dimensions <i>mm</i>	Diameter <i>mm</i>	Impact area <i>mm</i>	Ref. no.
Spacers	600	100		180	520	46-52826
	600	150		180	520	46-52827
	600	300		180	520	46-52828
Flexible column and pole protectors	600		100 x 100	180	520	46-52815
	600		150 x 150	180	520	46-52816
	600		200 x 200	180	520	46-52817
	600		250 x 250	180	520	46-52818
	600		300 x 300	180	520	46-52819
	600		350 x 350	180	520	46-52820
	600		400 x 400	180	520	46-52821
	600		450 x 450	180	520	46-52822
	600		500 x 500	180	520	46-52823
	600		550 x 550	180	520	46-52824
	600		600 x 600	180	520	46-52825



- Manufactured from flexible plastic
- Yields when there is a collision and forms back into its original shape when obstacle is removed
- Impact absorption prevents damage to barriers, vehicles and floor, reducing maintenance and repair, eliminating downtime
- Yellow/black signal striping guarantees high visual impact
- For outdoor and indoor use
- Easy to install, supplied with fixing material

## Flexible end-of-rack barriers

- Protects short sides of shelving and racking runs against collision damage
- Round posts reduce impact force, thereby minimising the potential for accidents and damage
- Innovative rotating pressure sleeves absorb and deflect impacts, transferring energy to the side
- Tested to withstand an impact of 12,000 joules
- Equals 8,6 t at 6 km/h at an impact angle of 45°
- Colour yellow & black



Length <i>mm</i>	Height <i>mm</i>	Base plate <i>mm</i>	Diameter <i>mm</i>	Impact area <i>mm</i>	Ref. no.
1100	512	230 x 230	190	185 - 405	46-52780
1200	512	230 x 230	190	185 - 405	46-52781
1300	512	230 x 230	190	185 - 405	46-52782
2400	512	230 x 230	190	185 - 405	46-52783
2500	512	230 x 230	190	185 - 405	46-52784
2600	512	230 x 230	190	185 - 405	46-52785





### Flexible impact barriers



product design award

- Manufactured from flexible plastic
- Yields when there is a collision and forms back into its original shape when obstacle is removed
- Impact absorption prevents damage to barriers, vehicles and floor, reducing maintenance and repair, eliminating downtime
- Yellow/black signal striping guarantees high visual impact
- For outdoor and indoor use
- Easy to install, supplied with fixing material



Protection from side impacts



Protection from front impacts



Tool kit for adjusting flexible buffer profiles

#### Flexible upright protectors

- Material plastic
- Colour yellow

Height <i>mm</i>	Upright type	Ref. no.
600	P1	46-45600
	P2	46-45601
	P3	46-45602
	P4-P7	46-45603

#### **i** BITO info

Assembly instructions can be downloaded from [www.bitto.com](http://www.bitto.com)



#### Tool kit for adjusting flexible buffer profiles, for flexible upright protectors

- The flexible buffer profiles can only be mounted with this tool kit. Please add this item to your order.
- Material plastic

	Ref. no.
Tool kit for adjusting flexible buffer profiles for flexible upright protectors	46-45604



# Impact protection barriers

## Light duty steel barriers

- Delimit hazard zones from walkways and driveways for general pedestrian use and operational vehicle traffic, suited for light duty applications
- Suited for all purposes
- Curved steel tube construction with additional steel tube at knee height, epoxy-coated with yellow/black signal striping
- Steel tube Ø 48 mm, wall thickness 2 mm, base plate 160 x 70 x 10 mm (L x W x H)
- Material steel
- Colour yellow & black



Dimensions H x L	Ref. no.
<i>mm</i>	
1000 x 1000	46-20600
1000 x 1500	46-20601
1000 x 2000	46-20602
Throughbolt anchors 12/120, suited for concrete floors, 4 floor anchors required per barrier	46-53527
Universal floor anchors S12 + bolt 8/100, 4 floor anchors required per barrier	46-20603

## Wheel stop barriers

- Designed to protect inventory, shelving and racking, machinery, etc. against impact damage from light and heavy duty service vehicles
- Low construction height allows easy staff access to restricted areas
- Thick-walled steel tube with tapered ends, epoxy-coated with yellow/ black signal striping
- Steel tube Ø 76 mm, wall thickness 3 mm, base plate 130 x 70 x 10 mm (L x W x H)
- Material steel
- Colour yellow & black



Dimensions H x L	Colour	Ref. no.
<i>mm</i>		
86 x 400	yellow & black	46-20604
86 x 800	yellow & black	46-20605
86 x 1200	yellow & black	46-20606
Throughbolt anchors 12/120, suited for concrete floors, 4 floor anchors required per barrier	galvanised	46-53527
Universal floor anchors S12 + bolt 8/100, 4 floor anchors required per barrier	galvanised	46-20603

## Wheel stop barriers for corner areas

- Designed to protect inventory, shelving and racking, machinery, etc. against impact damage, in particular from heavy duty service vehicles and trucks
- Low construction height allows easy staff access to restricted areas
- Thick-walled steel tube with tapered ends, epoxy-coated with yellow/ black signal striping
- Made from steel
- Colour: yellow/black



Dimensions H x L	Colour	Ref. no.
<i>mm</i>		
86 x 638 / 638	yellow & black	46-53486
Throughbolt anchors 12/120, suited for concrete floors, 8 floor anchors required per barrier	galvanised	46-53527
Universal floor anchors S12 + bolt 8/100, 8 floor anchors required per barrier	galvanised	46-20603

IDENTIFICATION & SAFETY



**Impact protection barriers**



IDENTIFICATION & SAFETY



**Heavy duty hoop barriers**

- Prevent collision damage from light duty and heavy duty service vehicles
- Designed to protect your equipment and facilities, such as switchboards, gates, shelving and racking, machinery
- Curved, heavy duty steel tube, yellow epoxy-coating with black signal striping
- Steel tube Ø 76 mm, wall thickness 3 mm, base plate 160 x 140 x 10 mm (L x W x H)

Dimensions H x L <i>mm</i>	Colour	Ref. no.
350 x 375	yellow	46-20607
350 x 750	yellow & black	46-20608
350 x 1000	yellow & black	46-20609
350 x 2000	yellow & black	46-53447
600 x 750	yellow & black	46-20610
600 x 1000	yellow & black	46-20611
600 x 2000	yellow & black	46-53448
1200 x 750	yellow & black	46-20612
1200 x 1000	yellow & black	46-20613
1200 x 2000	yellow & black	46-53449
Throughbolt anchors 12/120, suited for concrete floors, 8 floor anchors required per barrier	galvanised	46-53527
Universal floor anchors S12 + bolt 8/100, 8 floor anchors required per barrier	galvanised	46-20603



**Corner protection barriers**

- Prevent collision damage from light duty and heavy duty service vehicles
- Designed to protect your equipment and facilities, such as switchboards, gates, shelving and racking, machinery
- Curved, heavy duty steel tube, yellow epoxy-coating with black signal striping
- Steel tube Ø 76 mm, wall thickness 3 mm, base plate 160 x 140 x 10 mm (L x W x H)

Dimensions H x L / L <i>mm</i>	Colour	Ref. no.
350 x 600 / 600	yellow & black	46-20614
600 x 600 / 600	yellow & black	46-20615
1200 x 600 / 600	yellow & black	46-20616
Throughbolt anchors 12/120, suited for concrete floors, 12 floor anchors required per barrier	galvanised	46-53527
Universal floor anchors S12 + bolt 8/100, 12 floor anchors required per barrier	galvanised	46-20603



**Impact protection bollards**

- Designed to protect inventory, shelving and racking, machinery, etc. against impact damage from service vehicles and trucks, suited for light duty and particularly for heavy duty vehicles
- Extremely strong
- Hot-dip galvanised with additional epoxy-coating in yellow with black signal striping
- Thick-walled steel tube

Height <i>mm</i>	Diameter <i>mm</i>	Material thickness <i>mm</i>	Ref. no.
1200	90	3.6	46-20617
	159	4.5	46-20618
	194	4.5	46-20620
	273	5.0	46-20621
Heavy duty floor anchors, 14/110, for bollards Ø 90 and 159 mm, 4 floor anchors required per bollard		14	46-20619
Throughbolt anchors, 16/125, for bollards Ø 194 and 273 mm, 4 floor anchors required per bollard		16	41-20622

## Shelving & racking protection

### Upright protectors

- Provide protection against collision damage and prevent downtimes
- Epoxy-coating in signal yellow, RAL 1003, provides high visibility
- Bolt-on fixing to upright - no floor fixing to prevent damage to flooring if upright is hit by a vehicle
- Designed to fit BITO pallet racking PRO
- Delivery includes fixing material
- Material steel



Scan this QR code:

**Product video on upright protectors**

[www.bitto.com/qr-stuetzenschutz-int](http://www.bitto.com/qr-stuetzenschutz-int)

Height <i>mm</i>	Width <i>mm</i>	Upright type	Ref. no.
715	80	P1	66-31000
	90	P2	66-31001
	100	P3	66-31002
	120	P4-6	66-31003



→ Frames on page 199

### Column guards

- Compliant with the latest health and safety regulations stipulating that column guards must be fitted at the ends of each racking row
- Epoxy-coated in signal yellow, RAL 1003, yellow/black signal striping compliant to DIN 4844
- For 2-sided and for 3-sided protection
- Reliable protection of shelving and racking as well as service vehicles
- Clearly reduced damage to uprights and columns, therefore fewer idle times and lower costs
- Increased operator safety

Height <i>mm</i>	Description	Features	Upright type	Ref. no.
400	L-shaped for 2-sided protection	supplied with 4 heavy duty floor anchors Ø 12 mm	P1-P12	66-4585
	U-shaped for 3-sided protection	supplied with 4 chemical floor anchors M12	P1-P3	66-29123
			P4-P12	66-29125



→ More info on our upright types from page 200

IDENTIFICATION & SAFETY



**Rack end protector set**



**Rack end protector set**

- Protect short sides of shelving and racking runs and increase operator safety
- Since this barrier encloses both uprights of a frame, no extra column guards are required to protect the ends of a racking row
- Epoxy-coated in signal yellow, RAL 1003, yellow/black signal striping compliant to DIN 4844
- Galvanised steel sheet plank
- Delivery includes fixing material and heavy duty floor anchors
- Compliant with the latest health and safety regulations
- Clearly reduced damage to uprights and columns, therefore fewer idle times and lower costs
- A second steel plank can be added for increased safety

	<b>Rack end protector set</b>	<b>Additional fencing planks</b>
<b>Dimensions L x D x H</b>	<b>Ref. no.</b>	<b>Ref. no.</b>
<i>mm</i>		
1200 x 270 x 400	66-40937	66-40933
2500 x 270 x 400	66-40936	66-40932



**In-line posts for fencing rows**

- The in-line post and additional fencing planks allow to extend barrier length as required
- Helps to set up longer fencing rows
- This sturdy barrier system protects warehouse and operating equipment from damage
- Supplied with heavy duty floor anchors

<b>Dimensions L x D x H</b>	<b>Ref. no.</b>
<i>mm</i>	
250 x 201 x 400	66-40924





# Security mirrors

Perfect overview



- Minimises security hazards and increases traffic safety on your site

## Surveillance mirrors

- For indoor use
- Ideal for safeguarding production and storage environments
- Slightly convex shape provides a clear view of a larger area
- From shatterproof acrylic (70% more shock resistant than glass)
- Supplied with telescopic wall fixing bracket
- Material acrylic



Diameter <i>mm</i>	Viewing distance <i>m</i>	Ref. no.
300	1-4	46-39492
400	1-5	46-39493
500	5-7	46-39494
600	9-15	46-39495
700	12-17	46-39496
800	15-22	46-39497

## Security mirrors

- Frame with yellow/black marking
- Yellow/black signal striping ensures increased level of attention, in compliance with the latest safety regulations for hazard areas in factories and warehouses
- Improved view of out-of-the-way workplaces, elimination of dead angles
- Helps prevent accidents at work and production breakdowns
- Acrylic, brilliant vision, supplied with fixtures for wall mounting
- Material acrylic



Dimensions W x H <i>mm</i>	Viewing distance <i>m</i>	Ref. no.
300 x 500	5-7	46-39485
400 x 600	7-9	46-39486
600 x 900	18-25	46-39487
Fixing bracket for mirrors suited for tubes Ø 50-80 mm		46-39488

## 360° hemispherical mirrors

- For indoor use
- Worthwhile investment into safety at work
- All-round visibility to secure trafficways, particularly at intersections of racking aisles
- Low proper weight, long service life
- Manufactured from lightweight and shockproof acrylic (70% more shock resistant than glass)
- Can be attached directly to the wall/ceiling or chain-fixed to ceiling (please order chain kit separately)
- Material acrylic



**TOP SELLER!**  
46-39481



Diameter <i>mm</i>	Optional accessories	Viewing distance <i>m</i>	Ref. no.
600	46-39484	6	46-39480
800	46-39484	10	46-39481
1000	46-39484	30	46-39482
1250	46-55495	40	46-39483
Chain kit for hemispherical mirrors 4 chains, each 1000 mm long			46-39484
Chain kit for hemispherical mirrors 4 chains, each 2500 mm long			46-55495



**Display systems**

**Visual management**

Improve communication efficiency!

Our new display systems are ideal for informing all persons concerned about organisational measures, safety regulations and procedures to follow which will help you optimise office and warehouse workflows, thereby **saving time and money**.

A lot of management strategies such as Lean Management, Kaizen, 5S or 7M use colour display systems for providing quick and easy access to information. Even complex processes and difficult instructions can be presented in an easy-to-understand way.

Our **display systems** can be used for a wide range of applications:

**Display of notices, instructions and regulations.**

**Signal colouring in compliance with DIN ISO 3864-4 to ensure high visibility of emergency exits, prohibitive signs and warning signs.**

**For fire prevention instructions (red), machine operating instructions (blue) and substance hazard notices (orange).**



Self-adhesive document holders

Self-adhesive document holders "Security"

Display systems



IDENTIFICATION & SAFETY





### Self-adhesive document holders, magnetic pull-forward front

- Fully adhesive back provides durable fitting
- Magnetised closure is ideal for applications where frequent changes are required
- Holders have a high visibility colour frame in compliance with DIN 3864-4 on both sides and are therefore ideal for displaying info on glass doors
- Quick and easy access to information
- For horizontal or vertical display



Format	Colour	Pcs/ pack	Ref. no.
DIN A4	black	2	46-44462
	red	2	46-44463
	blue	2	46-44464
	orange	2	46-44465
	silver	2	46-44466
	black	10	46-44467
	red	10	46-44468
	blue	10	46-44469
	orange	10	46-44470
	silver	10	46-44471

### Self-adhesive document holders “Security”, magnetic pull-forward front, two colour frame

- Fully adhesive back provides durable fitting
- Magnetised closure is ideal for applications where frequent changes are required
- Holders have a high visibility colour frame in compliance with DIN 3864-4 on both sides and are therefore ideal for displaying info on glass doors
- Quick and easy access to information
- For horizontal or vertical display



Format	Colour	Pcs/ pack	Ref. no.
DIN A4	yellow & black	2	46-44472
	white/green	2	46-44473
	white/red	2	46-44474

### Magnetic document holders, with magnetic backing

- One-colour frame, magnetised on all 4 sides
- Protects documents from dirt, dust and creases
- Ideal for use on whiteboards, planning boards or fix directly to racking and machinery
- Quick and easy access to information
- For horizontal or vertical display

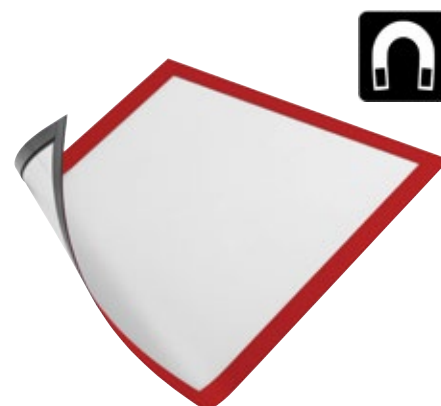

Format	Colour	Pcs/ pack	Ref. no.
DIN A4	black	5	46-44478
	red	5	46-44479
	blue	5	46-44480
	orange	5	46-44481
	silver	5	46-44482



IDENTIFICATION & SAFETY





**Display systems**



**Magnetic document holders “Security”, with magnetic backing and 2-colour frame**

- Two-colour frame, magnetised on all 4 sides
- Holders have a high visibility colour frame in compliance with DIN 3864-4
- Protects documents from dirt, dust and creases
- Ideal for use on whiteboards, planning boards or fix directly to racking and machinery
- Quick and easy access to information
- For horizontal or vertical display

Format	Colour	Pcs/ pack	Ref. no.
DIN A4	yellow & black	5	46-44483
	white/green	5	46-44484
	white/red	5	46-44485

**Display systems, with 1-colour frame, wall-mounted**

- Panel support from epoxy-coated metal
- 5 pockets (same colour) from flexible PP
- Capacity can be extended by adding extra units
- Kit complete with assembly instructions and fixing material

Format	Colour	Pcs/ pack	Ref. no.
DIN A4	red	Set	46-44450
	dark blue	Set	46-44451
	orange	Set	46-44452

**Display systems, with frame in different colours, wall-mounted**

- Panel support from epoxy-coated metal
- 10 pockets (assorted colours) from flexible PP
- Capacity can be extended by adding extra units
- Kit complete with assembly instructions and fixing material
- Ideal for displaying information related to diverse topics

Format	Delivery includes	Pcs/ pack	Ref. no.
DIN A4	2 pieces of each colour: black, red, yellow, green and dark blue	Set	46-44453

**Display systems, with 1-colour frame and magnetic backing**

- Panel support from epoxy-coated metal
- 5 pockets (same colour) from flexible PP
- Capacity can be extended by adding extra units
- Magnetic fixing to metallic surfaces such as shelving and racking, steel posts etc.

Format	Colour	Pcs/ pack	Ref. no.
DIN A4	black	Set	46-44454



## Document pockets

### Self-adhesive, 3 sides open

- Ideal for frequent exchange of inserts
- Adhesive fabric backing provides strong adhesion
- Colour transparent

**TOP SELLER**

6-5031

Dimensions L x W	Format	Pcs/ pack	Ref. no.
<i>mm</i>			
175 x 105		10	6-5031
210 x 75		10	6-31311
210 x 150	DIN A5	10	6-19528

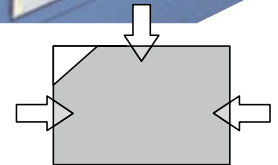

### Self-adhesive, 2 sides open

- Slightly shorter ticket holder front allows to easily insert and remove cards
- Material vinyl
- Colour blue

Dimensions L x W	Pcs/ pack	Ref. no.
<i>mm</i>		
145 x 100	25	46-21108

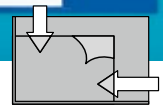

### Self-adhesive, 1 side open

- Document pocket with two self-adhesive strips
- Also suited for location marking on shelving and racking
- Durable adherence to all types of storage/transport bins and shelving/racking
- Material vinyl
- Colour blue

Dimensions L x W	Format	Pcs/ pack	Ref. no.
<i>mm</i>			
155 x 85		25	46-21109
235 x 170	DIN A5	25	46-21110



### With U-type bridge, right side open

- Robust backing with folded U-type bridge (bridge width 25 mm)
- Easy and reliable fixing to all types of storage and transport containers
- Material vinyl
- Colour blue

Dimensions L x W	Format	Pcs/ pack	Ref. no.
<i>mm</i>			
165 x 115	DIN A6	25	46-21105
235 x 170	DIN A5	25	46-21106
305 x 230	DIN A4	25	46-21107

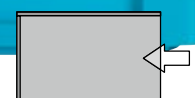

**Document pockets**

**TOP SELLER**

46-21104

**Document pockets, with wire fixing, open at top**

- Easy to fix to wire-mesh pallet boxes, collars, plastic containers, cartons, etc.
- Laminated wire earpieces for safe fixing
- Optimum protection for documents/markings
- Material PVC
- Colour transparent

Dimensions L x W <i>mm</i>	Format	Description	Pcs/pack	Ref. no.
195 x 140	DIN A6 landscape	without top fold	25	46-40304
275 x 180	DIN A5 landscape	without top fold	25	46-21104
275 x 185	DIN A5 landscape	with top fold to keep off rain	25	46-40307
275 x 340	DIN A4 portrait	without top fold	25	46-40303
	DIN A4 portrait	with top fold to keep off rain	25	46-40305
325 x 235	DIN A4 landscape	without top fold	25	46-21111
	DIN A4 landscape	with top fold to keep off rain	25	46-40306

**With magnetic backing, 1 side open**

- Fixes immediately on any steel surface such as on beams, storage and transport containers or directly on stored goods
- Material vinyl
- Colour blue

Dimensions L x W <i>mm</i>	Format	Pcs/pack	Ref. no.
160 x 115	DIN A6	25	46-21100
235 x 170	DIN A5	25	46-21101
305 x 230	DIN A4	25	46-21102

**i BITO info**

More options in our webshop at [shop.bitto.com](http://shop.bitto.com)

**With fixing flaps, open at top**

- Self-locking after inserting the flaps into pocket slashes
- Very easy to fix and to remove
- Material vinyl
- Colour blue

Dimensions L x W <i>mm</i>	Format	Pcs/pack	Ref. no.
235 x 180	DIN A5	25	46-21103

**With U-type bridge, 3 sides open**

- Robust backing with folded U-type bridge (bridge width 25 mm)
- Easy and reliable fixing to all types of storage and transport containers
- Made from rigid PVC
- Colour: transparent

Dimensions L x W <i>mm</i>	Height of fold at top <i>mm</i>	Pcs/pack	Ref. no.
105 x 78	16	25	46-40308
210 x 85	18	25	46-40309

IDENTIFICATION & SAFETY

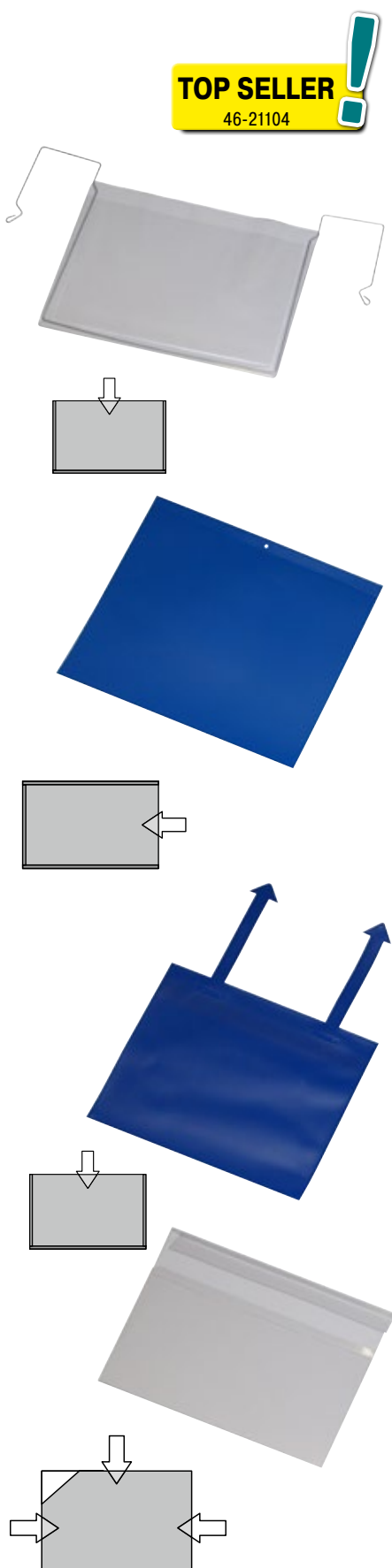

### Pallet foot sleeves, blue

- Instant load identification, quick removal and relocation
- With 4 label/barcode holders
- Made from PVC

Width	Height	Pcs/pack	Ref. no.
<i>mm</i>	<i>mm</i>		
145	75	25	46-40310



### Pallet foot sleeves, transparent

- Instant load identification, quick removal and relocation
- Seamless, rigid PVC sides provide excellent durability for frequent re-use
- With 1 label/barcode holder
- Made from rigid PVC
- Colour: transparent

Width	Height	Pcs/pack	Ref. no.
<i>mm</i>	<i>mm</i>		
145	75	25	46-40311



### Magnetic document pockets

- Neodymium magnets with an outstanding adhesive force keep pockets fixed to metal storage and transport containers, excellent for rough handling (outside use or during transport)
- Open top side
- Made from PVC

Dimensions L x W	Format	Height of fold at top	Pcs/pack	Ref. no.
<i>mm</i>		<i>mm</i>		
160 x 125	DIN A6 landscape	40	25	46-40312
235 x 180	DIN A5 landscape	40	25	46-40313
325 x 245	DIN A4 landscape	40	25	46-40314
240 x 350	DIN A4 portrait	40	25	46-40315

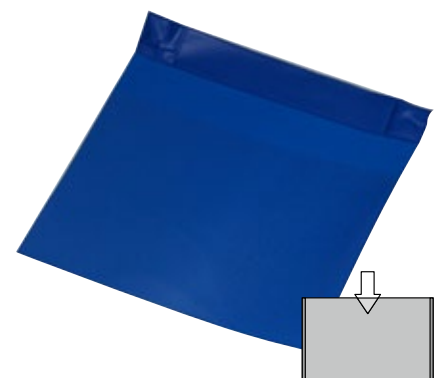



**Stock identification signs**

- To allow customisation of your stock labels and tiles, please state your order number, quantities and requested message, barcodes and/or arrow position at time of order
- Barcodes and/or positioning marks etc. upon request
- Black characters
- Character size is adapted to label height

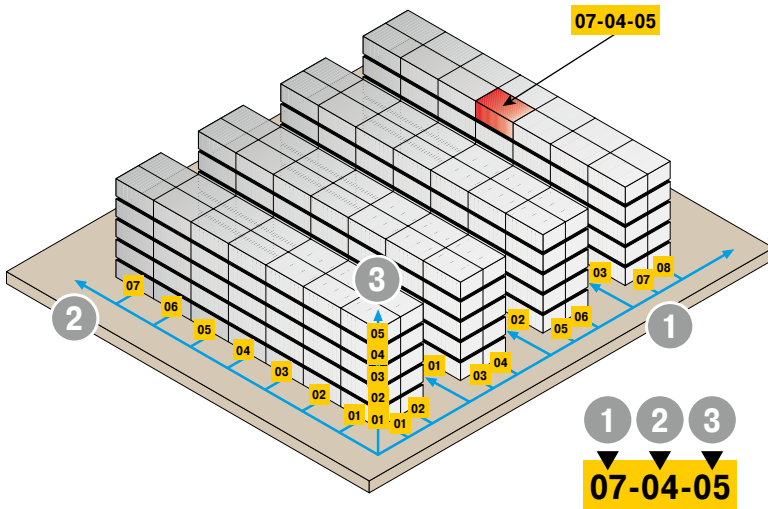

**i BITO info**

**... how to give your products a clear stock address**

Investing into a **stock location system** is relatively inexpensive and very rewarding from the organisational point of view as it helps you avoid unnecessary detours and cost intensive searching for a product. Systematic numbering of storage locations is the first step towards organising your warehouse. For this purpose, each storage location is defined by its racking row, bay number and storage level. These three coordinates provide a clear stock address and are the basis for manual and computerized warehouse management systems (see example).  
 In our example, the stock tile shows that a product is located in:  
 racking row = **07**, bay = **04**, level = **05**

IDENTIFICATION & SAFETY



**Stock labels**

- Self-adhesive polyethylene foil
- Other label and font colours upon request
- Other formats for labels with barcode on request
- Material polyurethane

Dimensions L x W <i>mm</i>	Colour	Ref. no.
120 x 30	yellow	46-20850
	white	46-20851
140 x 38	yellow	46-20852
	white	46-20853
220 x 58	yellow	46-20854
	white	46-20855



**Stock identification signs**

- Space for 1 or 2 characters (numbers or letters)
- Rigid PVC foam board
- Supplied with 2 fixing springs
- Fonts are scalable for customised marking
- Special formats upon request
- Material polystyrene

Dimensions L x W <i>mm</i>	Colour	Ref. no.
200 x 200	yellow	46-20856
	white	46-20857
300 x 300	yellow	46-20858
	white	46-20859
500 x 500	yellow	46-20860
	white	46-20861

Labels

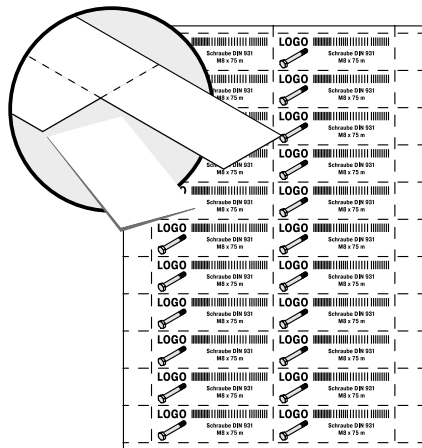

IDENTIFICATION & SAFETY

- Pre-perforated blank label sheets, ready for direct printing
- Suited for laser and inkjet printers
- On white DIN A4 sheets, 140 g/m<sup>2</sup>
- 25 sheets per pack
- Colour white

Suits		Dimensions W x H per label <i>mm</i>	Labels per pack	Ref. no.
European size stacking containers XL	Euro stacking containers XL from size 400 x 300 mm	210 x 74	100	46-20778
Small parts containers KLT	Small parts containers KLT from size 400 x 300 mm or larger	210 x 74	100	46-20778
Storage bins SK	SK1095	68,5 x 12,5	1600	46-20773
	SK1610	70,5 x 20	1000	46-20774
	SK2311, SK3521, SK3522	98 x 36	400	46-20775
	SK5031, SK5032/R	178 x 40	175	46-20776
	SK5031, SK5032/R	178 x 40	175	46-20776
	SK5033	178 x 56	125	46-20777
Storage and handling bins RK	RK*108	89 x 30	450	46-20767
	RK*109	84 x 39	375	46-20768
	RK*1509	115 x 39	250	46-20769
	RK*208	194 x 30	225	46-20770
	RK*209	192 x 39	175	46-20771
	RK*214	192 x 60	100	46-20772
Cross dividers	QT108, QT109	80 x 22	675	46-20766
	QT1509, QT208, QT209, QT214	98 x 36	400	46-20775
Self-adhesive ticket holders	BLD26*	85 x 26	550	46-20779
	BLD39*	84 x 39	375	46-20768
	BLD39*	115 x 39	250	46-20769
	BLD60*	192 x 60	100	46-20772

**Labels**

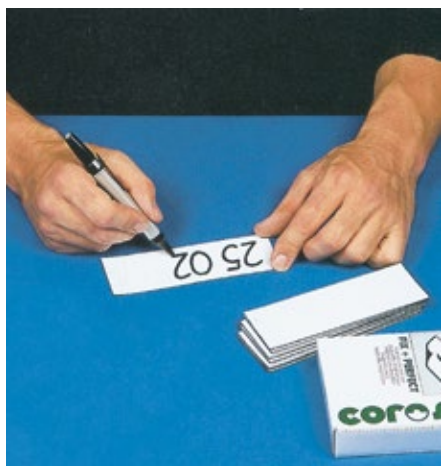

**Magnetic pre-cut labels**

- Fast marking with a felt marker, fixed in seconds
- Permanently magnetised
- Ideal for steel shelving and racking
- For durable and permanent marking, easy to remove for re-use
- Material magnetised foil
- Colour white

Length <i>mm</i>	Width <i>mm</i>	Pcs/pack	Ref. no.
80	25	50	46-10260
100	30	50	46-10261
150	50	50	46-10262



**Magnetic labels on rolls**

- 5-metre rolls, lengths to be cut on site as required
- Material magnetised foil
- Colour white

Length <i>mm</i>	Width <i>mm</i>	Pcs/pack	Ref. no.
5000	25	1	46-10263
	30	1	46-10264
	50	1	46-10265
	80	1	46-10266

IDENTIFICATION & SAFETY

**Display systems**



**For landscape and portrait documents**

- Flexible envelope allows easy insertion and removal of documents
- Anti-glare surface ensures easy readability
- Framed in red, yellow or green to attract attention

Format	Dimensions L x W <i>mm</i>	Description	Colour	Pcs/pack	Ref. no.
DIN A5	235 x 180	3 strong adhesive foam strips provide excellent adhesion	red	25	46-40325
			yellow	25	46-40326
			green	25	46-40327
		3 strong magnetic strips provide excellent adhesion	red	25	46-40328
			yellow	25	46-40329
			green	25	46-40330
DIN A4	325 x 240	3 strong adhesive foam strips provide excellent adhesion	red	25	46-40331
			yellow	25	46-40332
			green	25	46-40333
		3 strong magnetic strips provide excellent adhesion	red	25	46-40334
			yellow	25	46-40335
			green	25	46-40336

## Label holders



Pre-perforated print-on labels for your own printer on page 291

### Self-adhesive ticket holders

- Scanner readable
- Supplied with label cards
- Material rigid PVC
- Colour transparent

Overall height	Carton height	Length	Pcs/pack	Ref. no.
<i>mm</i>	<i>mm</i>	<i>mm</i>		
28	26	85	50	46-18115
		200	50	46-16508
		950	10	46-16509
		1200	10	46-16510
		1290	10	46-16511
		1735	10	46-16512
41	39	200	50	46-16514
		1290	10	46-16515
		1735	10	46-16516
62	60	200	50	46-16518



### Magnetic label pouches

- Ideal for frequent label replacement
- Two open sides allow convenient label positioning, front cover closes firmly on label
- Scanner-readable
- Delivery does not include labels
- Material vinyl
- Colour yellow



Dimensions L x W	Pcs/pack	Ref. no.
<i>mm</i>		
97 x 25	100	46-10272
97 x 30	100	46-10273
97 x 58	100	46-10274
120 x 40	100	46-10275
137 x 58	100	46-36040

### Magnetic label holders

- Immediate stock identification, label holders can be relocated together with your stock
- Full surface magnetised backing for immediate product marking
- Will also stick to message and planner boards
- Labels complete with label card and transparent cover strip
- Material C-profiles with magnetised reverse side
- Colour black



Length	Width	Pcs/pack	Ref. no.
<i>mm</i>	<i>mm</i>		
100	20	100	46-10267
	25	100	46-10268
	30	100	46-10269
	40	100	46-10270
	50	100	46-10271

IDENTIFICATION & SAFETY





## Improve your workflow with BITO!



In order to make in-house transport as efficient as possible, BITO has selected a product range that is perfectly tuned to storage and order picking needs.

All our products have been selected for their excellent workmanship and superior quality.

We are proud to present our functional, easy to handle and field-tested range of hand pallet trucks, order picking trolleys, sack trucks and shelf trolleys.

We are sure you will find the products that perfectly fit your needs!



**Contents**



IN-HOUSE TRANSPORT

LEO locative .....	296
Folding sack trucks .....	304
Tyre trucks .....	304
Sack trucks .....	305
Hand pallet trucks .....	306
TOTALSTOP central locking system.....	309
Transport dollies .....	310
Swan neck handle trolleys.....	311
Platform trucks with folding handle .....	312
Cash & Carry trolleys.....	313
Platform trucks with tubular handle.....	314
Four sided platform trucks .....	315
Platform trucks with wire/wood panel mesh sides .....	316
Table trolleys.....	318
Plastic deck trolleys .....	318
Table trolleys.....	319
Shelf trolleys.....	321
Platform trolleys/Platform trucks/ Table trolleys - Grey Edition.....	324
Shelf trolleys/Four sided platform trucks/ Pallet trolleys - Grey Edition .....	325
Platform trucks/Table trolleys/Shelf trolleys - ESD.....	326
Platform trucks/Table trolleys/Shelf trolleys.....	327
Order picking trolleys .....	328
Roll containers with wire mesh sides.....	331
Cantilever trolleys .....	332
Sheet material stands and trolleys.....	333
Transport dollies .....	334
Pallet dollies .....	335
Tipping skips.....	337
Roller conveyors.....	338
Skatewheel expandaveyors .....	343



### LEO TRANSPORTER

Your autonomous transport system

INGENIOUS & SIMPLE | BASICS AT A GLANCE | PERFORMANT & CONVINCING

The transporters of the BITO LEO family have been designed for handling bins and cardboard boxes without on-board driver. Transport to drop-off and pick-up stations is **fully automated** - and does not require an internet connection! In addition, the LEO system is **easily scalable, cost-efficient** and particularly **simple**, as the system setup and subsequent changes can be made without external help.



IN-HOUSE TRANSPORT



#### HOW DO LEO TRANSPORTERS WORK?

- LEO transporters follow a lane marking tape on the floor and recognize its color.
- They receive their travel instructions through optical markers (QR codes) on the floor.
- Travel instructions are shown on the integrated display.
- No need for WLAN or a master computer.
- Travel speed 0.7 m/second.
- Battery life 12 to 16 hours

#### YOUR BENEFITS

- You determine LEO's travel routes which can be modified at any time.
- LEO operates without WLAN or a host computer
- LEO transporters save your employees miles of walking distances and physically demanding tasks like lifting and carrying.



More info about

**LEO Transporter**

[www.leo-transporter.com](http://www.leo-transporter.com)



## LEO custom

What is LEO CUSTOM?

- **LEO custom is the basic unit for all LEO variants.**
- **With its punched mounting plate, LEO custom is perfectly suited for adding application specific on-top constructions.**
- **Load and towing capacity 55 kg**



## LEO locative

What is LEO LOCATIVE?

- **LEO locative is an automated guided vehicle (AGV)**
- **Designed for carrying bins, cartons and trays**
- **LEO links workstations and performs in-house transport tasks in all areas where goods must be moved, thus saving miles of walking distance.**
- **No complicated installation and or setup required.**
- **Safe and reliable operation through indicator lights and sensors**
- **Load capacity 35 kg**



IN-HOUSE TRANSPORT

## LEO flow

What is LEO FLOW?

- **LEO flow is a space-saving solution for in-house transport without onboard driver**
- **Powered rollers enable lateral drop-off and pick-up of cardboard boxes, bins and other load carriers with rigid edges**
- **Ideal for complementing and connecting existing conveyor systems**
- **The roller platform for load carriers can be automatically adjusted in height to form a flush level with other conveyor systems**
- **Seamless communication between your conveyor system and LEO**
- **Load capacity 35 kg**





### LEO custom

#### LEO custom transporter

- Delivery includes: 1 LEO locative transporter and 1 lithium battery

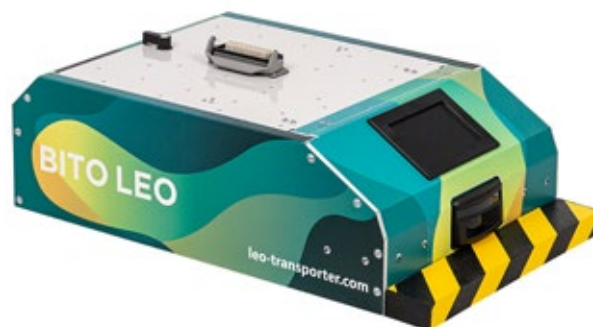

#### LEO custom starter package

- Delivery includes:
- 1 container XL 6412
- 1 insert bin
- 1 lithium battery charger
- 1 starter package with markers
- 1 service cable
- 1 power supply converter package
- 1 lane template
- Lane marking tape „heavy-duty“ in blue (25m)
- Lane marking tape „Flex“ in blue and in green (132m of each colour)

Type	Ref. no.
LEO custom transporter	80-56187
LEO custom starter package	80-56120



LEO custom with application specific on-top frame for transporting plastic car parts



## LEO locative

### LEO locative transporter

- Delivery includes: 1 LEO locative transporter and 1 lithium battery

### LEO starter package

- Delivery includes:
  - 1 container XL 6412
  - 1 insert bin
  - 1 lithium battery charger
  - 1 starter package with markers
  - 1 service cable
  - 1 power supply converter package
  - 1 lane template
  - Lane marking tape „heavy-duty“ in blue (25m)
  - Lane marking tape „Flex“ in blue and in green (132m of each colour)



Type	Ref. no.
LEO locative transporter	80-56177
LEO locative starter package	80-56121

### LEO locative transfer stations

- Drop-off station: LEO deposits loads
- Pick-up station: LEO picks up loads
- Twin station: LEO deposits one bin and retrieves another
- The configuration of the station indicates from which side LEO accesses the bin.
- All stations must be operated with 230V mains voltage
- All transfer station sets include **1 smart box lite, 1 mains adapter, 1x floor mounting material**



Type	Description	Ref. no.
LEO locative Drop-off station - set	left-hand side, supplied assembled	80-56228
LEO locative Drop-off station - set	right-hand side, supplied assembled	80-56227
LEO locative Pick-up station - set	left-hand side, supplied assembled	80-56226
LEO locative Pick-up station - set	right-hand side, supplied assembled	80-56225
LEO locative Twin station - set	left-hand side, supplied assembled	80-56230
LEO locative Twin station - set	right-hand side, supplied assembled	80-56229

### LEO locative Pufferbahnen

- Buffer lanes can be mounted directly to the station and allow you to expand and optimise your internal transport

Type	Total length approx. mm	Ref. no.
Buffer lane for LEO locative drop-off stations	1200	80-56223
Buffer lane for LEO locative drop-off stations	2400	80-56224
Buffer lane for LEO locative pick-up stations	1200	80-56221
Buffer lane for LEO locative pick-up stations	2400	80-56222
LEO locative powered roller platform		80-56160



## LEO flow

BITO LEO flow can transport one or more bins and other load carriers. Initially, on-top frames will be available in three sizes and in three variants. All on-top constructions have a load capacity of up to 35 kg.

## LEO flow transporter

- Delivery includes 1 LEO locative transporter and 1 lithium battery
- Available in different variants
  - for load sizes up to 800x600 mm
  - pick-up / drop-of in longitudinal or transverse direction
  - with fixed transfer height or automatic lifting unit



## LEO flow AGV with fixed transfer height

- The **minimum** selectable drop-off height is 400 mm from the bottom edge of the load carrier.
- The **maximum** selectable drop-off height is 1,200 mm from the bottom edge of the load carrier.
- The heights are determined specifically for each customer project.
- The height is fixed using spacer beams. Other installation heights require different spacers.

## LEO AGV with automatic lifting unit

- Automatic height adjustment is available as an option. The transfer height can be varied from 400 mm to 1,200 mm. The height is set individually at each pick-up or drop-off point and can be easily modified. This means that LEO flow can also be used in existing systems.





## LEO Battery and charging technology

## Accessories



A LEO lithium battery 24 V



B LEO Automatic charging station



D LEO Battery charger



E LEO plug-in power supply 24 V

Pos.	Description	Ref. no.	
A	LEO lithium battery 24 V	The battery of the LEO locative can be exchanged and recharged for shift operation.	80-55070
B	LEO Automatic charging station	LEO will be charged autonomously by entering the automatic charging station.	80-55700
C	LEO Charging bar	Technical upgrade by equipping a LEO vehicle (ex-works) with a charger bar for automatic charging	80-55701
D	LEO Battery charger	Charger for energy-efficient charging of LEO batteries with lithium technology (LiFePO4)	80-55556
E	LEO plug-in power supply 24 V	Required if you want to convert a twin station into two single stations.	80-48747

## Lithium battery data

- 24 V / 20 Ah
- 12-16 h driving capacity
- 1,000 - 5,000 charge cycles
- 7 kg replaceable battery

## Automatic charging

This optional, retrofittable system enables automatic lithium battery charging. For this purpose, the LEO transporter is equipped with a charging bar. LEO moves to a separate charging station after a certain period of time, depending on the charging mode.





### LEO Control

The LEO Smart Box is the decentralised control unit for the entire LEO system. This means that less infrastructure and interfaces are necessary. The installation and operation of the system are thus considerably simplified. In addition, the system is scalable, as it can be expanded step by step. It can be operated via the LEO tablet and the LEO locative app, a barcode scanner and a keypad.

#### Accessories

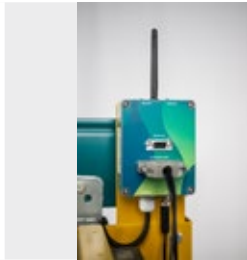

A LEO Smart Box lite



B LEO Smart Box pro



C LEO Tablet



D LEO tablet stand



E LEO Barcode scanner



F Starter marker package

Pos.	Description	Ref. no.
A	LEO Smart Box lite The LEO Smart Box is a decentralized control unit and represents the interface between LEO and the transfer stations. The Smart Box lite reduces the space required for the LEO station entrance.	80-53341
B	LEO Smart Box pro The Smart Box pro is suitable for complex control tasks.	80-55800
	LEO Upgrade Smart Box pro A Smart Box lite can be upscaled to a Smart Box pro with a system upgrade.	80-55801
C	LEO Tablet Tablet for entering target data	80-55066
D	LEO tablet stand For fixing the tablet to a wall or to a freestanding floor stand	80-55067
E	LEO Handheld scanner A barcode with the target information is fixed on the containers and the barcode scanner at the station transmits the information to the LEO Smart Box.	80-55065
F	Starter marker package 1 marker pack with over 100 markers, for all basic commands	80-55760



You can find a list of all markers in our LEO Wiki at [www.leo-transporter.com/de-de/leo-wiki/](http://www.leo-transporter.com/de-de/leo-wiki/)



## Accessories

### Accessories

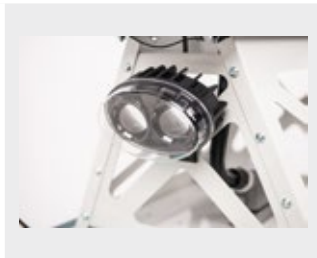

**A** LEO Blue-Spot warning light

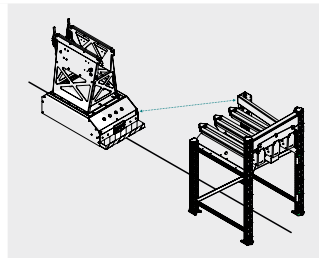

**B** LEO locative station transmitter, push-fit mounting



**C** LEO locative connector set for twin stations

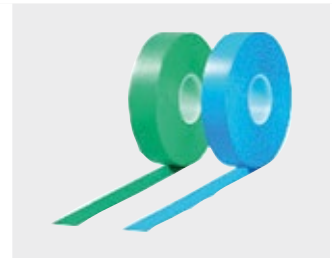

**D** Lane marking tape „flex“

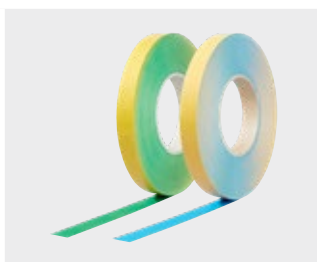

**E** Lane marking tape „robust“

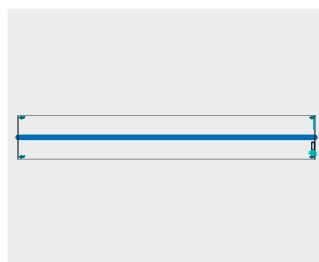

**F** Lane marking tape „ultra“



**G** 2-component LEO track paint



Pos.	Description	Description	Ref. no.	
<b>A</b>	LEO locative Blue Spot	Optical warning system for LEO vehicles to prevent collisions and increase safety at work.	80-54905	
<b>B</b>	LEO locative station transmitter, push-fit mounting	Required if you want to convert a twin station into two single stations.	80-48740	
<b>C</b>	LEO locative connector set for twin stations	Required if you want to convert a drop-off station and a pick-up station into a double station.	80-48741	
<b>D</b>	Lane marking tape „flex“	8 x 33 m lane marking tape <b>blue</b> , easy to apply and to remove, for light-duty applications	80-45774	
		8 x 33 m lane marking tape <b>green</b> , easy to apply and to remove, for light-duty applications	80-45773	
<b>E</b>	Lane marking tape „robust“	1 x 25 m lane marking tape <b>blue</b> , ideal for light and medium duty applications in regular-use areas , for medium-duty applications	80-45777	
		1 x 25 m lane marking tape <b>green</b> , ideal for light and medium duty applications in regular-use areas , for medium-duty applications	80-45776	
<b>F</b>	Lane marking tape „ultra“	1x 150 mm wide, very robust tape as a 25 m roll. The lane marking tape cannot be bent. For laying bends, we offer curve and turnout elements.	45° curve to the right	80-52146
			45° curve to the left	80-52147
			start of S-curve to the left	80-52151
			start of S-curve to the right	80-52150
			start of bypass to the left	80-52149
			start of bypass to the right	80-52148
			end of S-curve to the left	80-52153
			end of S-curve to the right	80-52152
			end of bypass to the left	80-52155
			end of bypass to the right	80-52154
			straight route markings, 25 m roll	80-52145
			Intersection	80-52162
turnaround to the left	80-52157			
turnaround to the right	80-52156			
<b>G</b>	2-component LEO track paint	The use of two-component varnish is the most resistant option for marking paths. The path is painted directly on the floor, line width 19 mm.	80-55555	



### Folding sack trucks



**TOP SELLER**

22-21305



- Aluminium/steel construction with aluminium toe plate and high grade PVC fittings
- Elasticated retaining straps and cross strut for safe transport
- Toe plate and wheels fold away with one move, telescopic grip, ready to use within seconds

#### Polymer tyres

- Ball bearing castors with trackless polymer tyres

Load capacity	Height	Toe plate dim. L x W	Total width	Dimensions H x W x D folded	Castor Ø	Weight	Ref. no.
kg	mm	mm	mm	mm	mm	kg	
50	1030	300 x 385	390	595 x 390 x 50	127 x 30	3.20	22-21304
125	1090	320 x 480	488	765 x 488 x 64	170 x 35	5.20	22-21305

#### Pneumatic tyres

- Ball bearing castors with pneumatic tyres

Load capacity	Height	Toe plate dim. L x W	Total width	Dimensions H x W x D folded	Castor Ø	Weight	Ref. no.
kg	mm	mm	mm	mm	mm	kg	
250	1190	450 x 595	660	855 x 660 x 135	220 x 70	12.60	22-21306

### Tyre trucks



- Pneumatic tyres 260 x 85 mm / solid rubber tyres 260 x 60 mm
- Welded steel tube construction, epoxy-coated in brilliant blue, RAL 5007

#### Tyre trucks

- Designed to take up to 8 tyres
- Handles with integral brace grippers for convenient tyre handling

Load capacity	Height	Total width	Toe plate dim. L x W	Tyres	Ref. no.
kg	mm	mm	mm		
200	1500	650	360 x 580	pneumatic	22-21345
200	1500	650	360 x 580	solid rubber	22-43621



## Sack trucks



- Welded steel tube construction, epoxy-coated in brilliant blue, RAL 5007
- Pneumatic tyres 260 x 85 mm / solid rubber tyres 260 x 60 mm



## Load capacity 200 kg

Load capacity	Height	Total width	Toe plate dim. L x W	Tyre material	Ref. no.
<i>kg</i>	<i>mm</i>	<i>mm</i>	<i>mm</i>		
200	1150	570	250 x 320	solid rubber	22-43525
200	1150	570	250 x 320	pneumatic	22-21203

## Load capacity 250 kg

Load capacity	Height	Total width	Toe plate dim. L x W	Tyre material	Ref. no.
<i>kg</i>	<i>mm</i>	<i>mm</i>	<i>mm</i>		
250	1150	590	150 x 400	solid rubber	22-43518
250	1150	590	150 x 400	pneumatic	22-21204

## Load capacity 300 kg

Load capacity	Height	Total width	Toe plate dim. L x W	Tyre material	Ref. no.
<i>kg</i>	<i>mm</i>	<i>mm</i>	<i>mm</i>		
300	1300	580	250 x 320	solid rubber	22-43364
300	1300	580	250 x 320	pneumatic	22-13695

## Board/panel trucks, standard version

- Designed for moving large-sized sheet materials from wood or plastic, with additional support castors

Load capacity	Height	Total width	Toe plate dim. L x W	Tyre material	Ref. no.
<i>kg</i>	<i>mm</i>	<i>mm</i>	<i>mm</i>		
400	1430	680	500 x 200	solid rubber	22-43364
350	1440	680	500 x 200	pneumatic	22-21205

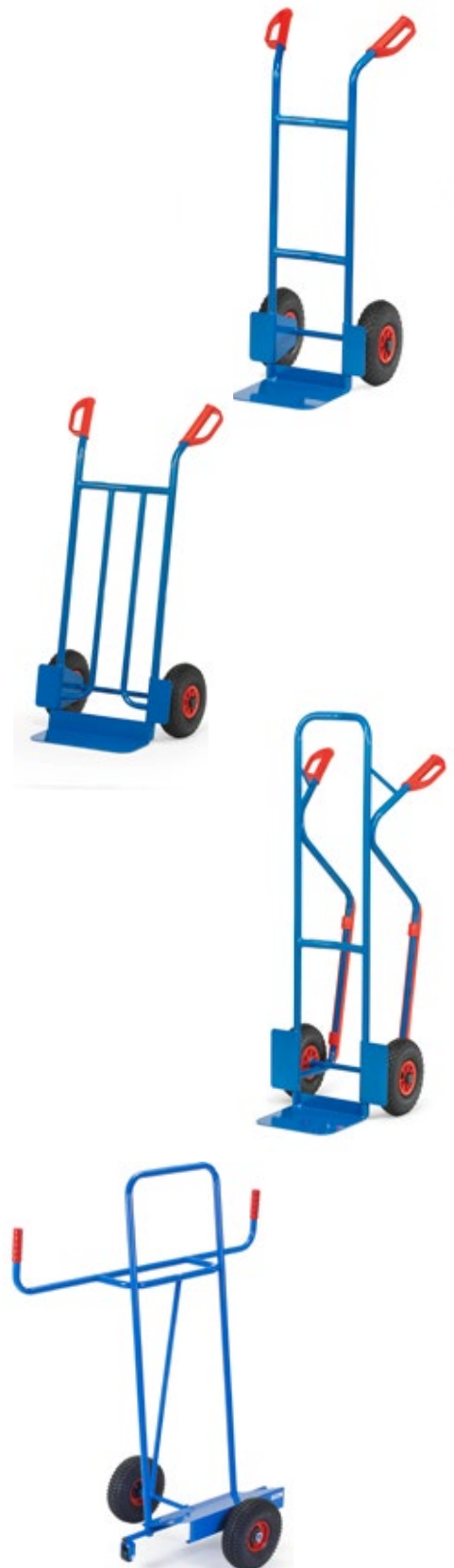

IN-HOUSE TRANSPORT





## Hand pallet trucks

Ideal for lifting, moving and positioning heavy or awkward loads

### ■ Designed for in-house transport of palletised loads

#### **i** BITO info

##### Wheel materials and features

**Nylon:** for smooth floor surfaces, high resistance to chemicals, very low rolling friction

**Solid rubber:** for smooth and rough floor surfaces, quiet in use

**Polyurethane:** kind to floors, abrasion-resistant and non-marking, resilient, quiet in use

**TOP SELLER**

22-21229



- Suited for the professional handling of palletised loads and mesh box pallets in demanding environments
- Turning angle 2 x 105°, tandem load rollers, stair climber rollers at fork tips
- Load capacity 2500 kg!

Load capacity	Width over forks	Fork dim. L x W	Load rollers made from	Swivel castors made from	Ref. no.
<i>kg</i>	<i>mm</i>	<i>mm</i>			
2500	540	1150 x 160	nylon	nylon	22-21227
			polyurethane	solid rubber	22-21229
			polyurethane	polyurethane	22-21230

### Hand pallet trucks, with short forks

- Suited for the professional handling of standard size palletised loads and mesh box pallets in demanding environments
- Easy to manoeuvre, with a rotation angle of the steering shaft of 2 x 105° the pallet truck is ideal for confined spaces
- Load capacity 2500 kg!



Load capacity	Width over forks	Fork dim. L x W	Load rollers made from	Swivel castors made from	Ref. no.
<i>kg</i>	<i>mm</i>	<i>mm</i>			
2500	540	600 x 160	nylon	solid rubber	22-39602
		800 x 160	polyurethane	solid rubber	22-39603
		900 x 160	polyurethane	solid rubber	22-39604

### Hand pallet trucks, with long forks

- Suited for the professional handling of long palletised loads and mesh box pallets in demanding environments
- Easy to manoeuvre, with a rotation angle of the steering shaft of 2 x 105° the pallet truck is ideal for confined spaces
- Tandem load rollers



Load capacity	Width over forks	Fork dim. L x W	Load rollers made from	Swivel castors made from	Ref. no.
<i>kg</i>	<i>mm</i>	<i>mm</i>			
2000	540	1500 x 160	polyurethane	solid rubber	22-39605
		1800 x 160	polyurethane	solid rubber	22-39606
		2000 x 160	polyurethane	solid rubber	22-39607
		2500 x 170	polyurethane	polyurethane	22-39608

### Hand pallet trucks, with speed control and parking brake

- Suited for the professional handling of palletised loads and mesh box pallets on loading ramps, ascending slopes and in lorries
- Very good vehicle stability on sloping floors
- Easy to manoeuvre, with a rotation angle of the steering shaft of 2 x 105° the pallet truck is ideal for confined spaces
- Tandem load rollers
- Load capacity 2500 kg!

Load capacity	Width over forks	Fork dim. L x W	Load rollers made from	Swivel castors made from	Ref. no.
kg	mm	mm			
2500	540	1150 x 160	polyurethane	solid rubber	22-39609



### Hand pallet trucks, with digital scales, 5kg-scaling

- Ideal for transporting and weighing palletised loads and mesh box pallets
- High readability LCD display
- Weight is displayed 5 kg increments
- Weighing range 0 - 2000 kg
- Weighing accuracy 0 - 500 kg ± 10 kg, 500 - 1.000 kg ± 20 kg, 1.000 - 2.000 kg ± 30 kg
- Battery operated (2 x 1.5 volt AA batteries)

Load capacity	Width over forks	Fork dim. L x W	Load rollers made from	Swivel castors made from	Ref. no.
kg	mm	mm			
2000	540	1150 x 160	polyurethane	polyurethane	22-39610



### Hand pallet trucks, with digital scales, 1kg-scaling

- Ideal for transporting and weighing palletised loads and mesh box pallets
- High readability LCD display
- Weight is displayed 1 kg increments
- Weighing range 0 - 2000 kg
- Weighing accuracy ± 0,1%
- Battery operated (4 x 1.5 volt AA batteries)

Load capacity	Width over forks	Fork dim. L x W	Load rollers made from	Swivel castors made from	Ref. no.
kg	mm	mm			
2000	570	1150 x 180	polyurethane	polyurethane	22-21231



### Hand pallet truck with scissor lift, with hydraulic manual release

- Designed to combine the functions of a hand pallet truck with a lift table for use with palletised loads, allow adjustment to optimum work height in production environments, at assembly stations and in dispatch services
- Steering wheels and load rollers from polyurethane
- Solid steel scissor legs ensure stability when elevated
- Three-position control handle for accelerated lifting speed, standard lifting speed and lowering
- Speed lift function for loads of up to 250 kg
- Safety valve provides overload protection

Load capacity	Width over forks	Lift height	Fork dim. L x W	External dimensions L x W x H	Ref. no.
kg	mm	mm	mm	mm	
1000	540	800	1150 x 160	1650 x 540 x 1235	22-39611





## Hand pallet trucks



IN-HOUSE TRANSPORT



### Manual stackers

- Ideal for occasional use, convenient stacking and moving palletised loads in in-house environments
- Steering wheels and load rollers from nylon
- Brake fitted to one steering wheel allows safe loading and unloading
- C-profiled mast with maintenance free, ball bearing cable and guide rollers for smooth operation of hand-crank winch
- Cable winch for precise height adjustment of forks
- Push handle for easy (re-)location

Load Capacity	Width over forks	Lift height	Fork dim. L x W	External dimensions L x W x H	Ref. no.
kg	mm	mm	mm	mm	
300	580	1500	600 x 160	1020 x 710 x 1840	22-39612
500	580	1500	900 x 160	1320 x 710 x 1840	22-39613



Load capacity 500 kg

### Hydraulic stackers

- Designed for general lifting tasks and occasional inhouse transport of goods, for shelving & racking replenishment as well as lorry loading and unloading
- Steering wheels and load rollers from polyurethane
- Optimised wheel spacing provides high tilting stability
- 2 lifting speeds allow to lift loads of up to 100 kg in a much shorter time
- Castors with hardened steel centres for a long service life
- Pressure-relief valve provides overload protection

Load Capacity	Width over forks	Lift height	Fork dim. L x W	External dimensions L x W x H	Ref. no.
kg	mm	mm	mm	mm	
500	200/770	1600	1150 x 100	1650 x 800 x 2000	22-39614
1000		900	1122 x 60	1675 x 765 x 1300	22-21232
		1600	1122 x 60	1675 x 765 x 1965	22-21233



Load capacity 1000 kg



**TOP SELLER**  
22-39615

### Scissor lift table, mobile version

- Designed for in-house lifting, moving and positioning loads wherever required
- Tyres from polyurethane
- Brake fitted to one steering wheel allows safe loading and unloading
- Heavy duty construction with hard chrome plunger rod and overload protection
- Push handle for easy and ergonomic (re-)location
- Foot lever operated hydraulic lifting

Load capacity	Lift height	Table top L x W	External dimensions L x W x H	Ref. no.
kg	mm	mm	mm	
150	720	700 x 450	908 x 450 x 960	22-39615
300	880	850 x 500	1093 x 500 x 984	22-39616
500	880	850 x 500	1093 x 500 x 984	22-39617
750	1000	1000 x 510	1330 x 600 x 990	22-39618

## TOTALSTOP central locking system



Innovative, convenient, ergonomically designed and safe!



- This new braking system can be operated with a simple push on the foot pedal
- The centrally fitted brake pedal is visible at first sight and can be accessed no matter how the wheels are positioned
- Rubber wheel lock works perfectly on all standard tyre materials
- All products bearing the **TOTALSTOP logo** can be supplied with this new braking system at an additional charge.
- Please state reference number of requested wheel diameter together with your trolley/truck order



Description	Ref. no.
for platform widths from 500 - 800 mm	22-39594



IN-HOUSE TRANSPORT

## Distribution trolleys now supplied with TPE tyres as standard

Easy and smooth transport

- **All transport trolleys that have been supplied with solid rubber tyres are now supplied with TPE tyres as a standard feature at no extra charge.**
- Tyres with TPE tread from thermoplastic elastomer have a lot of advantages on smooth floors
- Convenient, safe and quiet transport of loads, even heavy loads can be moved without effort
- Non-marking, dark coloured tread
- Compliant with the latest legislative requirements of the EU regulation 1272/2014 defining limit values for polycyclic aromatic hydrocarbons (PAH)
- Maintenance-free, deep groove ball bearing with both sides sealed
- Thread guard prevents loose threads from being wound around the axle



## Swivel castor kit complete with 4 castors



A smart move!

- Instead of 2 swivel and 2 fixed castors (swivel castors with brake) the product is supplied with 4 swivel castors (2 braked)
- Maximum manoeuvrability into all directions

Description	Ref. no.
Swivel castor kit complete with 4 castors	22-39601







## Transport dollies

plywood platform



EN 1757-3



- Angled steel framework, powder coated in brilliant blue, RAL 5007

### Transport dollies, no raised edge

- With 4 swivel castors (2 with brake), TPE tyres, low friction deep groove ball bearings
- Deck from beech wood laminate

Load capacity	Platform L x W	Castor Ø	Ref. no.
<i>kg</i>	<i>mm</i>	<i>mm</i>	
250	605 x 405	125	22-21200



### Platform trucks with tubular handle, with raised edges on all sides

- With 4 swivel castors (2 with brake), TPE tyres, low friction deep groove ball bearings
- Beech laminate deck with 15 mm upstand all round

Load capacity	Platform L x W	Castor Ø	Ref. no.
<i>kg</i>	<i>mm</i>	<i>mm</i>	
250	605 x 405	125	22-21277



### Transport dollies, with raised edges on all sides

- With 4 swivel castors (2 with brake), TPE tyres, low friction deep groove ball bearings
- Beech laminate deck with 15 mm upstand all round

Load capacity	Platform L x W	Castor Ø	Ref. no.
<i>kg</i>	<i>mm</i>	<i>mm</i>	
250	605 x 405	125	22-21276



### General purpose trolley, with raised edges on all sides

- With 4 swivel castors (2 with brake), TPE tyres, low friction deep groove ball bearings
- Decks from beech wood laminate with 15 mm upstand all round

Load capacity	Platform L x W	Castor Ø	Description	Ref. no.
<i>kg</i>	<i>mm</i>	<i>mm</i>		
250	605 x 405	125	without push bar	22-21278
			with push bar	22-21279

## Swan neck handle trolleys



- Supplied with 2 swivel castors with brake and 2 fixed castors, wheels with TPE tyre and deep groove ball bearing



EN 1757-3

## Open-decked

- Designed for European size stacking containers: 1 x 600 x 400 mm or 2 x 400 x 300 mm
- Angled steel framework, powder coated in brilliant blue, RAL 5007

Load capacity	External dimensions L x W x H	Overall height	Platform L x W	Castor Ø	Ref. no.
kg	mm	mm	mm	mm	
250	900 x 420 x 209	860	610 x 410	125	22-21280



## With veneered particle deck, 1 level

- Welded steel tube construction, epoxy-coated in brilliant blue, RAL 5007
- Deck from beech wood laminate

Load capacity	External dimensions L x W x H	Platform L x W	Castor Ø	Ref. no.
kg	mm	mm	mm	
250	890 x 500 x 860	600 x 500	125	22-14003



## With veneered particle deck, 2 levels

- Welded steel tube construction, epoxy-coated in brilliant blue, RAL 5007
- Decks from beech wood laminate
- Shelf level heights 195/770 mm

Load capacity	External dimensions L x W x H	Platform L x W	Castor Ø	Ref. no.
kg	mm	mm	mm	
250	860 x 450 x 875	600 x 450	125	22-14004



IN-HOUSE TRANSPORT



### Platform trucks with folding handle



IN-HOUSE TRANSPORT



EN 1757-3

#### With steel sheet platform

- Platform from pressed steel sheet
- Epoxy-coated in brilliant blue, RAL 5007
- Glue-fixed anti-slip matting and protective edging all round
- Fold-down push handle with wide cross strut, powder coated finish, folding hinges galvanised
- 2 swivel and 2 fixed castors, swivel castors with brake, solid rubber tyres, castors with roller bearing
- Option with 4 swivel castors not possible

Load capacity	External dimensions L x W x H	Platform L x W	Castor Ø	Weight	Ref. no.
kg	mm	mm	mm	kg	
150	760 x 495 x 860	740 x 480	100	12.50	22-20305
250	920 x 630 x 860	910 x 610	125	18.50	22-20306

#### Platform with non-slip surface

- Sturdy, rounded edges
- Fold-down push handle with wide cross strut, galvanised hinges
- 2 swivel and 2 fixed castors, swivel castors with brake, solid rubber tyres, castors with roller bearing
- Option with 4 swivel castors not possible

Load capacity	External dimensions L x W x H	Platform L x W	Castor Ø	Weight	Ref. no.
kg	mm	mm	mm	kg	
150	760 x 495 x 885	740 x 480	100	10.00	22-21303

#### Plywood platform

- Welded steel tube construction, epoxy-coated in brilliant blue, RAL 5007
- Deck from beech wood laminate
- Fold-down push handle
- Supplied with 2 swivel castors with brake and 2 fixed castors, wheels with TPE tyre and deep groove ball bearing
- Optionally available with 4 swivel castors and TOTALSTOP central locking system

Load capacity	External dimensions L x W x H	Platform L x W	Castor Ø	Weight	Ref. no.
kg	mm	mm	mm	kg	
250	815 x 470 x 930	720 x 450	125	15.00	22-13714
	995 x 620 x 965	900 x 600	160	24.00	22-20012
500	970 x 1057 x 509	850 x 500	160	24.31	22-55478
	1120 x 1099 x 609	1000 x 600	200	28.37	22-55479
	1120 x 1099 x 709	1000 x 700	200	31.68	22-55480
	1325 x 1099 x 809	1200 x 800	200	36.78	22-55481

#### Platform with checker plate surface

- Tubed framework, push handle and platform from aluminium
- Fold-down push handle
- Supplied with 2 swivel castors with brake and 2 fixed castors, wheels with TPE tyre and deep groove ball bearing
- Optionally available with 4 swivel castors and TOTALSTOP central locking system

Load capacity	External dimensions L x W x H	Platform L x W	Castor Ø	Weight	Ref. no.
kg	mm	mm	mm	kg	
200	815 x 470 x 930	720 x 450	125	10.00	22-21201
	995 x 620 x 965	900 x 600	160	17.00	22-21202

## Cash &amp; Carry trolleys



- Welded steel tube construction, epoxy-coated in brilliant blue, RAL 5007
- Platform from resin coated plywood with slip-resistant texture
- Trolleys can be nested - ideal for all locations with limited space
- Nesting saves 75% of the space that would be occupied by loaded trolleys
- Supplied with 2 swivel castors with brake and 2 fixed castors, wheels with TPE tyre and deep groove ball bearing



## With platform

Load capacity	External dimensions L x W x H	Platform L x W	Wheel dimensions	Ref. no.
kg	mm	mm	mm	
400	1045 x 643 x 959	850 x 500	160 x 40	22-43122
500	1212 x 743 x 1004	1000 x 600	200 x 50	22-43123
	1212 x 843 x 1004	1000 x 700	200 x 50	22-43124



## With 2 levels

- Shelf level height 265/775 mm = castor diameter 160 mm, shelf level height 310/820 mm = castor diameter 200 mm
- Load capacity of top shelf 80 kg

Load capacity	External dimensions L x W x H	Platform L x W	Wheel dimensions	Ref. no.
kg	mm	mm	mm	
400	1045 x 643 x 959	850 x 500	160 x 40	22-43125
500	1212 x 743 x 1004	1000 x 600	200 x 50	22-43126
	1212 x 843 x 1004	1000 x 700	200 x 50	22-43127



## With loop handles

- 2 loop handles 680 mm high on swivel castor sides and 2 loop handles 500 mm high on fixed castor sides

Load capacity	External dimensions L x W x H	Platform L x W	Wheel dimensions	Ref. no.
kg	mm	mm	mm	
400	1045 x 643 x 949	850 x 500	160 x 40	22-43128
500	1212 x 743 x 990	1000 x 600	200 x 50	22-43129
	1212 x 843 x 990	1000 x 700	200 x 50	22-43130







### Platform trucks with tubular handle



EN 1757-3



You will find this option on page 309

- Supplied with 2 swivel castors with brake and 2 fixed castors, wheels with TPE tyre and deep groove ball bearing
- Welded steel tube construction, epoxy-coated in brilliant blue, RAL 5007
- Deck from beech wood laminate



### Platform trolleys, plywood platform

Load capacity	External dimensions L x W x H	Platform L x W	Castor Ø	Ref. no.
kg	mm	mm	mm	
250	1100 x 450 x 910	850 x 450	125	22-12895
	1250 x 600 x 910	1000 x 600	125	22-12896
400	1030 x 505 x 953	850 x 500	160	22-21206
	1180 x 705 x 953	1000 x 700	160	22-21207

### Platform trucks with tubular handle, plywood platform

Load capacity	External dimensions L x W x H	Platform L x W	Castor Ø	Ref. no.
kg	mm	mm	mm	
500	975 x 509 x 958	850 x 500	160	22-14000
600	1125 x 609 x 990	1000 x 600	200	22-14001
	1125 x 709 x 990	1000 x 700	200	22-14007
	1325 x 809 x 990	1200 x 800	200	22-14002



IN-HOUSE TRANSPORT

## Four sided platform trucks

- Supplied with 2 swivel castors with brake and 2 fixed castors, wheels with TPE tyre and deep groove ball bearing
- Welded steel tube construction, epoxy-coated in brilliant blue, RAL 5007
- Deck from beech wood laminate



You will find this option on page 309



EN 1757-3

### Mesh sided platform trucks, 1 long side foldable

- 50x50x4 mm square wire mesh infill, welded to framework

Load capacity <i>kg</i>	External dimensions L x W x H <i>mm</i>	Platform L x W <i>mm</i>	Useable height <i>mm</i>	Castor Ø <i>mm</i>	Ref. no.
600	1060 x 715 x 1069	1000 x 700	700	200	22-39549
	1260 x 815 x 1069	1200 x 800	700	200	22-39550



### Mesh sided platform trucks, 1 long side foldable, foldable lid

- Welded steel tube construction, epoxy-coated in brilliant blue, RAL 5007
- Deck from beech wood laminate

Load capacity <i>kg</i>	External dimensions L x W x H <i>mm</i>	Platform L x W <i>mm</i>	Useable height <i>mm</i>	Castor Ø <i>mm</i>	Ref. no.
600	1130 x 725 x 1113	1000 x 700	806	200	22-39553
	1330 x 825 x 1113	1200 x 800	806	200	22-39554



### Panelled platform trucks, 1 long side foldable

- Sides with plywood infill and beechwood finish

Load capacity <i>kg</i>	External dimensions L x W x H <i>mm</i>	Platform L x W <i>mm</i>	Useable height <i>mm</i>	Castor Ø <i>mm</i>	Ref. no.
600	1060 x 715 x 1069	1000 x 700	700	200	22-39551
	1260 x 815 x 1069	1200 x 800	700	200	22-39552



### Panelled platform trucks, 1 long side foldable, foldable lid

- Sides and lid with plywood infill and beechwood finish
- Eyelet for padlock fitting

Load capacity <i>kg</i>	External dimensions L x W x H <i>mm</i>	Platform L x W <i>mm</i>	Useable height <i>mm</i>	Castor Ø <i>mm</i>	Ref. no.
600	1130 x 725 x 1113	1000 x 700	806	200	22-39555
	1330 x 825 x 1113	1200 x 800	806	200	22-39556





### Platform trucks with wire mesh sides



EN 1757-3



You will find this option on page 309

- Supplied with 2 swivel castors with brake and 2 fixed castors, wheels with TPE tyre and deep groove ball bearing
- Welded steel tube construction, epoxy-coated in brilliant blue, RAL 5007
- Deck from beech wood laminate
- Short and long sides with 50x50x4 mm rod infill
- Panel height on short sides and on long side 500 mm

IN-HOUSE TRANSPORT



#### Platform trucks with one short side, sides wire mesh infill

Load capacity	External dimensions L x W x H	Platform L x W	Castor Ø	Ref. no.
kg	mm	mm	mm	
500	970 x 509 x 948	850 x 500	160	22-39518
600	1120 x 609 x 990	1000 x 600	200	22-39519
	1120 x 709 x 990	1000 x 700	200	22-39520
	1320 x 809 x 990	1200 x 800	200	22-39521



#### Platform trucks with two short sides, sides wire mesh infill

Load capacity	External dimensions L x W x H	Platform L x W	Castor Ø	Ref. no.
kg	mm	mm	mm	
500	1030 x 509 x 948	850 x 500	160	22-39522
600	1180 x 609 x 990	1000 x 600	200	22-39523
	1180 x 709 x 990	1000 x 700	200	22-39524
	1380 x 809 x 990	1200 x 800	200	22-39525



#### Platform trucks with three sides, sides wire mesh infill

Load capacity	External dimensions L x W x H	Platform L x W	Castor Ø	Ref. no.
kg	mm	mm	mm	
500	1030 x 509 x 948	850 x 500	160	22-39526
600	1180 x 609 x 990	1000 x 600	200	22-39527
	1180 x 709 x 990	1000 x 700	200	22-39528
	1380 x 809 x 990	1200 x 800	200	22-39529



#### Platform trucks with four sides, sides wire mesh infill

- One long-side panel can be removed

Load capacity	External dimensions L x W x H	Platform L x W	Castor Ø	Ref. no.
kg	mm	mm	mm	
500	1030 x 509 x 948	850 x 500	160	22-39530
600	1180 x 609 x 990	1000 x 600	200	22-39531
	1180 x 709 x 990	1000 x 700	200	22-39532
	1380 x 809 x 990	1200 x 800	200	22-39533





## Platform trucks with wood panel sides

- Supplied with 2 swivel castors with brake and 2 fixed castors, wheels with TPE tyre and deep groove ball bearing
- Welded steel tube construction, epoxy-coated in brilliant blue, RAL 5007
- Platform and front end/side panels from beech laminate
- Panel height on short sides and on long side 500 mm



You will find this option on page 309



EN 1757-3

## Platform trucks with one short side, sides from wood laminate

Load capacity	External dimensions L x W x H	Platform L x W	Castor Ø	Ref. no.
kg	mm	mm	mm	
500	970 x 509 x 948	850 x 500	160	22-21329
600	1120 x 609 x 990	1000 x 600	200	22-21330
	1120 x 709 x 990	1000 x 700	200	22-21331
	1320 x 809 x 990	1200 x 800	200	22-21332



## Platform trucks with two short sides, sides from wood laminate

Load capacity	External dimensions L x W x H	Platform L x W	Castor Ø	Ref. no.
kg	mm	mm	mm	
500	1030 x 509 x 948	850 x 500	160	22-21333
600	1180 x 609 x 990	1000 x 600	200	22-21334
	1180 x 709 x 990	1000 x 700	200	22-21335
	1380 x 809 x 990	1200 x 800	200	22-21336



## Platform trucks with three sides, sides from wood laminate

Load capacity	External dimensions L x W x H	Platform L x W	Castor Ø	Ref. no.
kg	mm	mm	mm	
500	1030 x 509 x 948	850 x 500	160	22-21337
600	1180 x 609 x 990	1000 x 600	200	22-21338
	1180 x 709 x 990	1000 x 700	200	22-21339
	1380 x 809 x 990	1200 x 800	200	22-21340



## Platform trucks with four sides, sides from wood laminate

- One long-side panel can be removed

Load capacity	External dimensions L x W x H	Platform L x W	Castor Ø	Ref. no.
kg	mm	mm	mm	
500	1030 x 509 x 948	850 x 500	160	22-21341
600	1180 x 609 x 990	1000 x 600	200	22-21342
	1180 x 709 x 990	1000 x 700	200	22-21343
	1380 x 809 x 990	1200 x 800	200	22-21344







### Table trolleys

with steel shelves



- 2 swivel and 2 fixed castors, swivel castors with brake, solid rubber tyres
- Fixed steel tube push handle
- Steel sheet decks with glue-fixed anti-slip matting
- Option with 4 swivel castors not possible

#### 2 levels and 2 handles

- Load capacity of top shelf 60 kg

Load capacity	External dimensions L x W x H	Platform L x W	Shelf level heights	Castor Ø	Ref. no.
kg	mm	mm	mm	mm	
120	760 x 495 x 860	740 x 480	140, 655	100	22-21307



#### 3 shelf levels, 2 handles

- Load capacity of top shelf / intermediate shelf level 60 kg

Load capacity	External dimensions L x W x H	Platform L x W	Shelf level heights	Castor Ø	Ref. no.
kg	mm	mm	mm	mm	
120	760 x 495 x 860	740 x 480	140, 390, 655	100	22-21308

### Plastic deck trolleys



- Supplied with 2 swivel and 2 fixed castors, solid rubber tyres
- Decks moulded in polypropylene, with anti-slip surface, colour blue
- Option with 4 swivel castors not possible

#### 1 level

- Fold-down handle with broad cross brace and hinges, galvanised

Load capacity	External dimensions L x W x H	Platform L x W	Castor Ø	Ref. no.
kg	mm	mm	mm	
200	815 x 540 x 890	810 x 500	125	22-37595



#### 2 levels

- Double deck table trolley, with fitted push handle, galvanised
- Shelf level heights 185 and 715 mm
- Overall height 890 mm

Load capacity	External dimensions L x W x H	Platform L x W	Castor Ø	Ref. no.
kg	mm	mm	mm	
200	815 x 540 x 890	810 x 500	125	22-37594





## Table trolleys

with multiplex shelves

- Supplied with 2 swivel castors with brake and 2 fixed castors, wheels with TPE tyre and deep groove ball bearing
- Welded steel tube construction, epoxy-coated in brilliant blue, RAL 5007
- Decks from beech wood laminate



You will find this option on page 309



EN 1757-3

### 2 levels and 2 handles

- Load capacity of top shelf 80 kg

Load capacity	Shelf level heights	External dimensions L x W x H	Platform L x W	Castor Ø	Ref. no.
kg	mm	mm	mm	mm	
200	209, 826	1030 x 500 x 1020	850 x 500	125	22-21208
		1180 x 600 x 1020	1000 x 600	125	22-21209

### 3 shelf levels, 2 handles

- Load capacity of top shelf / intermediate shelf level 80 kg

Load capacity	Shelf level heights	External dimensions L x W x H	Platform L x W	Castor Ø	Ref. no.
kg	mm	mm	mm	mm	
200	209, 515, 826	1030 x 500 x 1020	850 x 500	125	22-21282
		1180 x 600 x 1020	1000 x 600	125	22-21283

### 2 levels and 1 handle

- Load capacity of top shelf 120 kg

Load capacity	Shelf level heights	External dimensions L x W x H	Platform L x W	Castor Ø	Ref. no.
kg	mm	mm	mm	mm	
400	233, 736	970 x 505 x 968	850 x 500	160	22-21210
		1120 x 705 x 968	1000 x 700	160	22-21211

### 3 shelf levels and 1 handle

- Load capacity of top shelf / intermediate shelf level 120 kg

Load capacity	Shelf level heights	External dimensions L x W x H	Platform L x W	Castor Ø	Ref. no.
kg	mm	mm	mm	mm	
400	233, 485, 736	970 x 505 x 968	850 x 500	160	22-21284
		1120 x 705 x 968	1000 x 700	160	22-21285



IN-HOUSE TRANSPORT



## Table trolleys

with multiplex shelves



EN 1757-3



You will find this option on page 309

**TOP SELLER**  
22-21216



- Supplied with 2 swivel castors with brake and 2 fixed castors, wheels with TPE tyre and deep groove ball bearing
- Welded steel tube construction, epoxy-coated in brilliant blue, RAL 5007
- Decks from beech wood laminate

### 2 lipped shelves and 1 handle

- Load capacity of top shelf 80 kg
- Drop-in levels fitted into steel angle framework with 12 mm upstand

Load capacity	Shelf level heights	External dimensions L x W x H	Platform L x W	Castor Ø	Ref. no.
kg	mm	mm	mm	mm	
300	200, 820	985 x 500 x 1040	850 x 500	125	22-21216
		1135 x 600 x 1040	1000 x 600	125	22-12897
		1136 x 711 x 1039	1000 x 700	125	22-55470
		1336 x 811 x 1039	1200 x 800	125	22-55471

### 3 lipped shelf levels and 1 handle

- Load capacity of top shelf / intermediate shelf level 80 kg
- Drop-in levels fitted into steel angle framework with 12 mm upstand

Load capacity	Shelf level heights	External dimensions L x W x H	Platform L x W	Castor Ø	Ref. no.
kg	mm	mm	mm	mm	
300	200, 510, 820	985 x 500 x 1040	850 x 500	125	22-21217
		1135 x 600 x 1040	1000 x 600	125	22-12898
		1136 x 711 x 1039	1000 x 700	125	22-55472
		1336 x 811 x 1039	1200 x 800	125	22-55473

### 2 levels and 1 handle

- Load capacity of top shelf 200 kg

Load capacity	Shelf level heights	External dimensions L x W x H	Platform L x W	Castor Ø	Ref. no.
kg	mm	mm	mm	mm	
500	228, 860	1047 x 509 x 860	850 x 500	160	22-21212
600	270, 900	1197 x 609 x 900	1000 x 600	200	22-21213
		1197 x 709 x 900	1000 x 700	200	22-21214
		1397 x 809 x 900	1200 x 800	200	22-21215

### 3 shelf levels and 1 handle

Load capacity	Shelf level heights	External dimensions L x W x H	Platform L x W	Castor Ø	Ref. no.
kg	mm	mm	mm	mm	
500	228, 544, 860	1047 x 509 x 860	850 x 500	160	22-21286
600	270, 585, 900	1197 x 609 x 900	1000 x 600	160	22-43047
		1197 x 709 x 900	1000 x 700	200	22-21287
		1397 x 809 x 900	1200 x 800	200	22-21288



See our range from page 319



**Shelf trolleys**

- Supplied with 2 swivel castors with brake and 2 fixed castors, wheels with TPE tyre and deep groove ball bearing
- Welded steel tube construction, epoxy-coated in brilliant blue, RAL 5007
- Decks from beech wood laminate
- Levels are adjustable on a 100 mm pitch
- Shelf load capacity 90 kg



You will find this option on page 309



**EN 1757-3**

**3 levels**

Load capacity <i>kg</i>	Shelf level heights <i>mm</i>	External dimensions L x W x H <i>mm</i>	Shelf level L x W <i>mm</i>	Castor Ø <i>mm</i>	Ref. no.
500	228, 628, 1028	1019 x 509 x 1111	850 x 500	160	22-21218
600	269, 669, 1069	1169 x 609 x 1152	1000 x 600	200	22-21234
		1169 x 709 x 1152	1000 x 700	200	22-21235
		1369 x 809 x 1152	1200 x 800	200	22-21236

**4 levels**

Load capacity <i>kg</i>	Shelf level heights <i>mm</i>	External dimensions L x W x H <i>mm</i>	Shelf level L x W <i>mm</i>	Castor Ø <i>mm</i>	Ref. no.
500	228, 628, 1028, 1428	1019 x 509 x 1511	850 x 500	160	22-21219
600	269, 669, 1069, 1469	1169 x 609 x 1552	1000 x 600	200	22-21220
		1169 x 709 x 1552	1000 x 700	200	22-21221
		1369 x 809 x 1552	1200 x 800	200	22-21237

**4 levels**

Load capacity <i>kg</i>	Shelf level heights <i>mm</i>	External dimensions L x W x H <i>mm</i>	Shelf level L x W <i>mm</i>	Castor Ø <i>mm</i>	Ref. no.
600	269, 669, 1069, 1469	1169 x 609 x 1800	1000 x 600	200	22-21238
		1169 x 709 x 1800	1000 x 700	200	22-21239
		1369 x 809 x 1800	1200 x 800	200	22-21240

**5 levels**

Load capacity <i>kg</i>	Shelf level heights <i>mm</i>	External dimensions L x W x H <i>mm</i>	Shelf level L x W <i>mm</i>	Castor Ø <i>mm</i>	Ref. no.
600	269, 569, 869, 1169, 1469	1169 x 609 x 1800	1000 x 600	200	22-21241
		1169 x 709 x 1800	1000 x 700	200	22-21242
		1369 x 809 x 1800	1200 x 800	200	22-21243



**TOP SELLER**  
22-21239



IN-HOUSE TRANSPORT





### Shelf trolleys

with steel tube sides



EN 1757-3



You will find this option on page 309



- Supplied with 2 swivel castors with brake and 2 fixed castors, wheels with TPE tyre and deep groove ball bearing
- Welded steel tube construction, epoxy-coated in brilliant blue, RAL 5007
- Decks from beech wood laminate
- Levels are adjustable on a 100 mm pitch
- Shelf load capacity 90 kg

#### 4 levels

Load capacity	Shelf level heights	External dimensions L x W x H	Shelf level L x W	Castor Ø	Ref. no.
kg	mm	mm	mm	mm	
600	269, 669, 1069, 1469	1169 x 609 x 1800	1000 x 600	200	22-21297
		1169 x 709 x 1800	1000 x 700	200	22-21298
		1369 x 809 x 1800	1200 x 800	200	22-21299

#### 5 levels

Load capacity	Shelf level heights	External dimensions L x W x H	Shelf level L x W	Castor Ø	Ref. no.
kg	mm	mm	mm	mm	
600	269, 569, 869, 1169, 1469	1169 x 609 x 1800	1000 x 600	200	22-21300
		1169 x 709 x 1800	1000 x 700	200	22-21301
		1369 x 809 x 1800	1200 x 800	200	22-21302

### Shelf trolleys

sides wire mesh infill



EN 1757-3



You will find this option on page 309



- Supplied with 2 swivel castors with brake and 2 fixed castors, wheels with TPE tyre and deep groove ball bearing
- Welded steel tube construction, epoxy-coated in brilliant blue, RAL 5007
- Decks from beech wood laminate
- Levels are adjustable on a 100 mm pitch
- Shelf load capacity 90 kg
- Short sides and 1 long side with 100x100x5 mm rod infill

#### Short sides with wire-mesh infill

Load capacity	External dimensions L x W x H	Shelf level L x W	Shelf level heights	Ref. no.
kg	mm	mm	mm	
600	1169 x 709 x 1800	1000 x 700	269, 669, 1069, 1469	22-39539
	1369 x 809 x 1800	1200 x 800	269, 669, 1069, 1469	22-39540

#### Short sides and 1 long side with wire-mesh infill

Load capacity	External dimensions L x W x H	Shelf level L x W	Shelf level heights	Ref. no.
kg	mm	mm	mm	
600	1169 x 709 x 1800	1000 x 700	269, 669, 1069, 1469	22-39541
	1369 x 809 x 1800	1200 x 800	269, 669, 1069, 1469	22-39542



## Shelf trolleys

### with foldable shelf levels

- Supplied with 2 swivel castors with brake and 2 fixed castors, wheels with TPE tyre and deep groove ball bearing
- Welded steel tube construction, epoxy-coated in brilliant blue, RAL 5007
- 3-piece levels from waterproof plywood fitted with piano hinges along the folding line, bolted to angled support profiles
- Folded shelf level safely catches in the grooves of the angled support profiles to prevent accidental unfolding

### Shelf trolleys, with foldable shelf levels

- All sides open

Load capacity	External dimensions L x W x H	Shelf level L x W	Shelf level heights	Ref. no.
kg	mm	mm	mm	
600	1169 x 709 x 1800	1000 x 700	269, 669, 1069, 1469	22-39543
	1369 x 809 x 1800	1200 x 800	269, 669, 1069, 1469	22-39544

### Shelf trolleys, with wire-mesh sides and foldable shelf levels

- Short sides and 1 long side with 100x100x5 mm rod infill

Load capacity	External dimensions L x W x H	Shelf level L x W	Shelf level heights	Ref. no.
kg	mm	mm	mm	
600	1169 x 709 x 1800	1000 x 700	269, 669, 1069, 1469	22-39545
	1369 x 809 x 1800	1200 x 800	269, 669, 1069, 1469	22-39546



EN 1757-3



You will find this option on page 309



IN-HOUSE TRANSPORT

## Shelf trolleys

### with inclined shelves

- Supplied with 2 swivel castors with brake and 2 fixed castors, wheels with TPE tyre and deep groove ball bearing
- Welded steel tube construction, epoxy-coated in brilliant blue, RAL 5007
- Decks from beech wood laminate
- Inclined shelf levels are adjustable on a 120 mm pitch
- Levels can be fitted in a straight position or in an inclined position with a 15° or a 30° slope
- Shelf load capacity 80 kg
- Drop-in levels fitted into steel angle framework with 15 mm upstand on long sides

### 2 adjustable shelf levels

Load capacity	External dimensions L x W x H	Shelf level L x W	Castor Ø	Shelf trolleys	
				Ref. no.	Inclined shelves Ref. no.
kg	mm	mm	mm		
500	1430 x 620 x 1560	1250 x 610	200	22-21322	22-21324
	1830 x 620 x 1560	1650 x 610	200	22-21323	22-21325

### 3 adjustable shelf levels

Load capacity	External dimensions L x W x H	Shelf level L x W	Castor Ø	Shelf trolleys	
				Ref. no.	Inclined shelves Ref. no.
kg	mm	mm	mm		
500	1430 x 620 x 1800	1250 x 610	200	22-21326	22-21324
	1830 x 620 x 1800	1650 x 610	200	22-21327	22-21325



You will find this option on page 309



EN 1757-3



### Platform trolleys / Platform trucks / Table trolleys - Grey Edition



You will find this option on page 309

EN 1757-3



#### Platform trolleys - Grey Edition, plywood platform

- Welded steel tube construction, epoxy-coated in anthracite grey, RAL 7016
- Wood laminate deck with grey surface finish
- Handle can be bolt-fitted
- Supplied with 2 swivel castors with brake and 2 fixed castors, wheels with TPE tyre and deep groove ball bearing

Load capacity	External dimensions L x W x H	Platform L x W	Wheel dimensions	Ref. no.
kg	mm	mm	mm	
250	1100 x 450 x 910	850 x 450	125 x 32	22-53146
	1250 x 600 x 910	1000 x 600	125 x 32	22-53147

#### Platform trucks with tubular handle - Grey Edition

- Welded steel tube construction, epoxy-coated in anthracite grey, RAL 7016
- Wood laminate deck with grey surface finish
- Supplied with 2 swivel castors with brake and 2 fixed castors, wheels with TPE tyre and deep groove ball bearing



Load capacity	External dimensions L x W x H	Platform L x W	Wheel dimensions	Ref. no.
kg	mm	mm	mm	
500	970 x 509 x 948	850 x 500	160 x 40	22-53175
600	1120 x 609 x 990	1000 x 600	200 x 40	22-53176
	1120 x 709 x 990	1000 x 700	200 x 40	22-53177
	1325 x 809 x 990	1200 x 800	200 x 40	22-53178

#### Table trolleys - Grey Edition, with multiplex shelves

- Welded steel tube construction, epoxy-coated in anthracite grey, RAL 7016
- Decks from wood laminate with 12 mm upstand all round, surface colour grey
- Supplied with 2 swivel castors with brake and 2 fixed castors, wheels with TPE tyre and deep groove ball bearing
- Load capacity of top shelf 80 kg



Load capacity	Shelf level heights	External dimensions L x W x H	Platform L x W	Wheel dimensions	Ref. no.
kg		mm	mm	mm	
300	200, 510, 820	985 x 500 x 1040	850 x 500	125 x 32	22-53181
		1135 x 600 x 1040	1000 x 600	125 x 32	22-53182
	200, 820	985 x 500 x 1040	850 x 500	125 x 32	22-53179
		1135 x 600 x 1040	1000 x 600	125 x 32	22-53180

**Shelf trolleys / Four sided platform trucks / Pallet trolleys - Grey Edition**



You will find this option on page 309



EN 1757-3



IN-HOUSE TRANSPORT

**Shelf trolleys - Grey Edition**

- Welded steel tube construction, epoxy-coated in anthracite grey, RAL 7016
- Decks from wood laminate, surface colour grey
- Levels are adjustable on a 100 mm pitch
- Load capacity per shelf level 90 kg
- Supplied with 2 swivel castors with brake and 2 fixed castors, wheels with TPE tyre and deep groove ball bearing

Load capacity <i>kg</i>	Shelf level heights	External dimensions L x W x H <i>mm</i>	Shelf level L x W <i>mm</i>	Wheel dimensions <i>mm</i>	Ref. no.
600	269, 669, 1069, 1469	1169 x 609 x 1800	1000 x 600	200 x 40	22-53202
		1169 x 709 x 1800	1000 x 700	200 x 40	22-53203
		1369 x 809 x 1800	1200 x 800	200 x 40	22-53204



**Four sided platform trucks - Grey Edition, sides with rod infill**

- Angled steel framework with tubular push handle, short sides, 1 long side and top panel with welded mesh infill 40 x 40 x 4 mm, powder coating in RAL 7016 anthracite grey
- 2 hinged doors to close open long side, angled steel framework with welded grid infill
- Espagnolette bolt with door lever handle and cylinder lock
- 1 fitted and 4 adjustable shelf levels from rigid, heavy duty sandwich board, colour: medium grey
- Load capacity per shelf level 90 kg
- Maximum handling convenience: very low roller friction for smooth starts, easy and low-noise running and low swivel resistance on even surfaces
- 2 swivel and 2 fixed castors, swivel castors with TOTALSTOP brake as standard feature, thermoplastic elastomer tyres (TPE), precision deep groove ball bearing

Load capacity <i>kg</i>	Shelf level heights	External dimensions L x W x H <i>mm</i>	Platform L x W <i>mm</i>	Wheel dimensions <i>mm</i>	Ref. no.
750	292, 582, 882, 1182, 1482	1170 x 745 x 1792	1000 x 680	200 x 40	22-53200
		1370 x 845 x 1792	1200 x 780	200 x 40	22-53201



**Pallet dollies - Grey Edition, with location lugs**

- Angled steel framework, powder coated in anthracite grey, RAL 7016, with 4 location lugs
- Supplied with 2 swivel and 2 fixed castors, swivel castors with brake

Load capacity <i>kg</i>	External dimensions L x W x H <i>mm</i>	Platform L x W <i>mm</i>	Wheel dimensions <i>mm</i>	Ref. no.
750	1255 x 855 x 329	1210 x 810	200 x 40	22-53163





## Platform trucks / Table trolleys / Shelf trolleys

electrically conductive version (ESD)



You will find this option on page 309

- Welded, electrically conductive steel tube construction, epoxy-coated in slate grey, RAL 7015
- Shelf levels from electrically conductive laminate, compliant to DIN 68765, colour: light grey
- ESD version protects your goods from electrostatic discharge
- 2 swivel and 2 fixed castors, swivel castors with brake, electrically conductive tyres from thermoplastic elastomers (TPE ESD), hubs with deep groove ball bearing

### Platform trucks with tubular handle, electrically conductive version (ESD)



Load capacity	External dimensions L x W x H	Platform L x W	Shelf level heights	Wheel dimensions	Ref. no.
<i>kg</i>	<i>mm</i>	<i>mm</i>	<i>mm</i>	<i>mm</i>	
500	970 x 509 x 950	850 x 500	235	160 x 40	22-43191
600	1120 x 609 x 990	1000 x 600	276	200 x 50	22-43192
	1120 x 709 x 990	1000 x 700	276	200 x 50	22-43193
	1320 x 809 x 990	1200 x 800	276	200 x 50	22-43194

### ESD table trolleys, 2 levels and 1 handle

- Load capacity top deck 200 kg



Load capacity	External dimensions L x W x H	Platform L x W	Shelf level heights	Wheel dimensions	Ref. no.
<i>kg</i>	<i>mm</i>	<i>mm</i>	<i>mm</i>	<i>mm</i>	
500	1040 x 509 x 867	850 x 500	235, 867	160 x 40	22-43187
600	1390 x 809 x 908	1200 x 800	276, 908	200 x 40	22-43190
	1190 x 709 x 908	1000 x 700	276, 908	200 x 40	22-43189
	1190 x 609 x 908	1000 x 600	276, 908	200 x 40	22-43188

### Shelf trolleys - ESD version, 5 levels

- 1 fitted and 4 adjustable shelf levels from electrically conductive beechwood laminate in compliance with DIN 68765, colour: grey
- Shelf levels can be adjusted in height on a 100 mm pitch
- Load capacity per shelf level 50 kg



Load capacity	External dimensions L x W x H	Shelf level L x W	Shelf level heights	Wheel dimensions	Ref. no.
<i>kg</i>	<i>mm</i>	<i>mm</i>	<i>mm</i>	<i>mm</i>	
600	1169 x 609 x 1800	1000 x 600	276, 576, 876, 1176, 1476	200 x 40	22-43214
	1169 x 709 x 1800	1000 x 700	276, 576, 876, 1176, 1476	200 x 40	22-43215
	1369 x 809 x 1800	1200 x 800	276, 576, 876, 1176, 1476	200 x 40	22-43216



## Platform trucks / Table trolleys / Shelf trolleys

for heavy loads up to 1200 kg

- Welded steel tube construction, epoxy-coated in brilliant blue, RAL 5007
- Decks from plywood with non-slip moisture resistant resin coating
- Designed for heavy loads
- Castors with non-marking tyres from solid elastic rubber on ball bearing hubs can easily be moved into any direction and have very low rolling friction
- Supplied with 2 swivel and 2 fixed castors, swivel castors with brake, non-marking tyres from blue-grey elastic rubber on ball bearing hub



You will find this option on page 309



### Platform trucks with one short side, with plywood deck

- Short side from plywood with moisture resistant plywood coating
- Front panel height 500 mm

Load capacity <i>kg</i>	External dimensions L x W x H <i>mm</i>	Platform L x W <i>mm</i>	Shelf level heights <i>mm</i>	Wheel dimensions <i>mm</i>	Ref. no.
1200	1155 x 700 x 1005	1000 x 700	283	200 x 50	22-43319
	1355 x 800 x 1005	1200 x 800	283	200 x 50	22-43320
	1755 x 800 x 1005	1600 x 800	283	200 x 50	22-43321
	2155 x 800 x 1005	2000 x 800	283	200 x 50	22-43322



### Table trolleys, 2 levels and 1 handle

- Rectangular decks from plywood with non-slip moisture resistant resin coating
- Load capacity top deck 500 kg

Load capacity <i>kg</i>	External dimensions L x W x H <i>mm</i>	Platform L x W <i>mm</i>	Shelf level heights <i>mm</i>	Wheel dimensions <i>mm</i>	Ref. no.
1200	1210 x 700 x 925	1000 x 700	283, 925	200 x 50	22-43324
	1410 x 800 x 925	1200 x 800	283, 925	200 x 50	22-43325
	1810 x 800 x 925	1600 x 800	283, 925	200 x 50	22-43326
	2210 x 800 x 925	2000 x 800	283, 925	200 x 50	22-43327



### Shelf trolleys, 4 levels

- 1 fitted and 3 adjustable shelf levels from resin coated plywood with slip-resistant coating on one side and smooth the other side
- Shelf levels can be adjusted in height on a 100 mm pitch
- Load capacity per shelf level 180 kg

Load capacity <i>kg</i>	External dimensions L x W x H <i>mm</i>	Shelf level L x W <i>mm</i>	Shelf level heights <i>mm</i>	Wheel dimensions <i>mm</i>	Ref. no.
1200	1173 x 700 x 1583	1000 x 700	283, 688, 1088, 1488	200 x 50	22-43332
	1373 x 800 x 1583	1200 x 800	283, 688, 1088, 1488	200 x 50	22-43333





### Order picking trolleys

modular system



- Multifunctional, modular system with clip-on and bolt-on fittings
- Robust framework made from steel profiles/steel tubes, zinc plated
- Short sides with wire-mesh infill welded to frame, mesh width 100 x 50 mm, both short sides are linked with 2 struts for added rigidity
- Bottom deck with wire-mesh infill welded to the frame, mesh width 120 x 30 mm
- 2 push handles can be bolt-fixed vertically at the requested height to one short end panel
- 4 low friction swivel castors, 2 with brake, TPE tyres on plastic centre, hubs with deep groove ball bearing
- 4 bumpers from thermoplastic polyurethane (TPU) fitted to swivel castors



IN-HOUSE TRANSPORT



### Order picking trolleys - modular system, standard version

Load capacity	Platform L x W	External dimensions L x W x H	Wheel dimensions	Ref. no.
<i>kg</i>	<i>mm</i>	<i>mm</i>	<i>mm</i>	
200	650 x 510	891 x 590 x 1225	125 x 32	22-48560
		891 x 590 x 1625	125 x 32	22-48563
300	850 x 610	1091 x 690 x 1225	125 x 32	22-48561
		1091 x 690 x 1625	125 x 32	22-48564
		1091 x 690 x 1825	125 x 32	22-48566
	1250 x 610	1491 x 690 x 1225	125 x 32	22-48562
		1491 x 690 x 1625	125 x 32	22-48565
		1491 x 690 x 1825	125 x 32	22-48567

### Accessories



**A** Shelf levels with wire infill



**B** Back cladding



**C** Memo board



**D** Marking board



**E** Tow bar and coupling pin



**F** Wire dividers



**G** Wire dividers



**H** Access steps



**I** Guide roller



**J** Scanner holder



**K** Bottle holder

Pos.	Description	Platform L x W	Height	Pcs/ pack	Ref. no.
A	Shelf levels with wire infill 120 x 30 mm wired shelf levels, zinc plated, with 23 mm upward fold on one long side, on the other long side with 23 mm downward fold, adjustable on a 100 mm pitch in straight or tilted position	650 x 510		1	22-48572
		850 x 610		1	22-48573
		1250 x 610		1	22-48574
B	Back cladding bolt-on fitting to a long side, 100 x 50 mm wire mesh infill welded to frame, zinc plated	650 x 510	1225	1	22-48586
		650 x 510	1625	1	22-48589
		850 x 610	1225	1	22-48587
		850 x 610	1625	1	22-48590
		850 x 610	1825	1	22-48592
		1250 x 610	1225	1	22-48588
		1250 x 610	1625	1	22-48591
		1250 x 610	1825	1	22-48593
C	Memo board from steel sheet with epoxy coating in light grey, RAL 7035, can be fitted at any height on short side panel, supplied with paper clip, angle of incline can be adjusted with wire holder			1	22-48568
D	Marking board from steel sheet with epoxy coating in matt black, can be fitted at any height on short side panel, suited for chalk writing, supplied with paper clip			1	22-48569
E	Tow bar and coupling pin allows trains of 3 picking trolleys max., supplied with 2 fixed castors instead of 2 swivel castors without brakes, tow bar from flat rolled steel, pressure-springs automatically lift towing bar into vertical position when not in use, heavy duty coupling pin on opposite short side, trucks/dollies can be linked to each other with a foot operated mechanism, cannot be combined with steps, max. towing speed 6 km / h	width 510		1	22-48578
		width 610		1	22-48579
F	Wire dividers, for wired trolley platforms slide-on fitting, wire mesh infill welded to frame, zinc plated	width 510		1	22-48584
		width 610		1	22-48585
G	Wire dividers, for wire-mesh shelving	width 510		1	22-48582
		width 610		1	22-48583
H	Access steps tubular steel framework, antislip melamine treads, treads stand firmly on the ground as soon as weight is applied thus immobilising the access steps, a safety catch prevents the trolley from tilting, a gas spring helps to fold the step flat to the trolley, steps are supplied with a pair of deeper loop handles for added handling convenience, total length increases by 100 mm, cannot be combined with tow bar and tow coupling, 3 treads, uppermost tread at a height of 600 mm, reach height approx. 2800 mm	width 510		1	22-48580
		width 610		1	22-48581
I	Guide roller a spring loaded arm with a fifth TPE tyred castor provides directional stability, Ø 125 mm, on-the-spot turning remains possible	650 x 510		1	22-48575
		850 x 610		1	22-48576
		1250 x 610		1	22-48577
J	Scanner holder from steel sheet with epoxy coating in light grey, RAL 7035, many fitting positions at the rear and on the sides, punched tube profile with grip clamp to fix scanner pocket, can be positioned anywhere along push handle, scanner pocket size 120 x 87 x 150 mm (WxDxH), front opening: 40 mm wide			1	22-48571
K	Bottle holder steel holder with plastic strapping, strong and flexibel, suited for all standard beverage bottles and cans from 0.33 to 1.5 litres			1	22-48570







## Order picking trolleys



EN 1757-3



IN-HOUSE TRANSPORT

- Supplied with 2 swivel castors with brake and 2 fixed castors, wheels with TPE tyre and deep groove ball bearing
- Welded steel tube construction, epoxy-coated in brilliant blue, RAL 5007
- Decks from beech wood laminate
- Treads at the front end that retract when not in use and stand firmly on the ground as soon as weight is applied thus immobilising the access steps



### 2 levels

- Load capacity of top shelf 80 kg

Load capacity	External dimensions L x W x H	Shelf level L x W	Shelf level heights	Height of uppermost tread	Castor Ø	Ref. no.
kg	mm	mm	mm	mm	mm	
250	1322 x 611 x 1155	1000 x 600	200, 820	504	125	22-17612



### 3 levels

- Load capacity of top shelf / intermediate shelf level 80 kg

Load capacity	External dimensions L x W x H	Shelf level L x W	Shelf level heights	Height of uppermost tread	Castor Ø	Ref. no.
kg	mm	mm	mm	mm	mm	
250	1322 x 611 x 1155	1000 x 600	200, 510, 820	504	125	22-21222



### 3 levels

- Load capacity of top shelf / intermediate shelf level 80 kg

Load capacity	External dimensions L x W x H	Shelf level L x W	Shelf level heights	Height of uppermost tread	Castor Ø	Ref. no.
kg	mm	mm	mm	mm	mm	
250	1322 x 611 x 1880	1000 x 600	200, 825, 1445	928	125	22-17613



### 4 levels

- Load capacity of top shelf / intermediate shelf level 80 kg

Load capacity	External dimensions L x W x H	Shelf level L x W	Shelf level heights	Height of uppermost tread	Castor Ø	Ref. no.
kg	mm	mm	mm	mm	mm	
250	1322 x 611 x 1880	1000 x 600	200, 680, 1155, 1630	928	125	22-21223

**Roll containers with wire mesh sides**



- Durable all steel welded base frame and steel tubes, powder coated finish in brilliant blue, RAL 5007, bolted construction
- Deck from beech wood laminate
- Supplied with 2 swivel castors with brake and 2 fixed castors, all castors with TPE tyre 200 x 40 mm, deep groove ball bearings



You will find this option on page 309



**Without doors**

- Short sides and rear with 100x100x5 mm rod infill

Load capacity	Castor Ø	Shelf level heights	Overall height	Platform L x W	Ref. no.
kg	mm	mm	mm	mm	
600	200	269	1552	1000 x 700	22-37794
				1200 x 800	22-37795
			1800	1000 x 700	22-37796
				1200 x 800	22-37797
Shelf levels, for shelf trolleys / roll containers				1000 x 700	22-39547
				1200 x 800	22-39548



IN-HOUSE TRANSPORT

**With hinged double doors**

- Steel tube framework with welded grid infill, grid size 100 x 100 x 5 mm
- Double doors fitted to one long side
- Tubed frame comes with integral latch lock, padlock can be fitted (not supplied)
- Double doors can be hinged to short sides or to push handle

Load capacity	Castor Ø	Shelf level heights	Overall height	Dimensions L x W	Platform L x W	Ref. no.
kg	mm	mm	mm	mm	mm	
600	200	269	1552	1000 x 700	1000 x 700	22-37798
				1200 x 800	1200 x 800	22-37799
			1800	1000 x 700	1000 x 700	22-37599
				1200 x 800	1200 x 800	22-37598
Shelf levels, for shelf trolleys / roll containers				1000 x 700		22-39547
				1200 x 800		22-39548
Document pockets, without top fold				275 x 180		46-21104
				325 x 235		46-21111





## Cantilever trolleys



EN 1757-3



You will find this option on page 309



### Cantilever trolleys, single sided use

- Supplied with 2 swivel castors with brake and 2 fixed castors, all castors with TPE tyre 200 x 40 mm, deep groove ball bearings
- Strong angle framework
- Horizontal and vertical tubes as well as arms are connected to each other by sturdy screw clamps
- Epoxy-coated in brilliant blue, RAL 5007
- Useful height 1450 mm
- 12 clamp-fixed support arms from steel tube Ø 27 mm, useful depth 600 mm
- Load capacity per level 80 kg

Load capacity <i>kg</i>	Description	External dimensions L x W x H <i>mm</i>	Dimensions at base L x D <i>mm</i>	Ref. no.
500	single sided use	1400 x 800 x 1807	1200 x 800	22-39559
		1800 x 800 x 1807	1600 x 800	22-39560
		2200 x 800 x 1807	2000 x 800	22-39561
	with PVC sleeve	1400 x 800 x 1807	1200 x 800	22-39562
		1800 x 800 x 1807	1600 x 800	22-39563
		2200 x 800 x 1807	2000 x 800	22-39564

### Cantilever trolleys, double sided use

- Supplied with 2 swivel castors with brake and 2 fixed castors, all castors with TPE tyre 200 x 40 mm, deep groove ball bearings
- Strong angle framework
- Horizontal and vertical tubes as well as arms are connected to each other by sturdy screw clamps
- Epoxy-coated in brilliant blue, RAL 5007
- Useful height 1450 mm
- 24 clamp-fixed support arms from steel tube Ø 27 mm, useful depth 2 x 370 mm
- Load capacity per level 120 kg (60 kg each side)

Load capacity <i>kg</i>	Description	External dimensions L x W x H <i>mm</i>	Dimensions at base L x D <i>mm</i>	Ref. no.
500	standard version	1400 x 800 x 1807	1200 x 800	22-39565
		1800 x 800 x 1807	1600 x 800	22-39566
		2200 x 800 x 1807	2000 x 800	22-39567
	with PVC sleeve	1400 x 800 x 1807	1200 x 800	22-39568
		1800 x 800 x 1807	1600 x 800	22-39569
		2200 x 800 x 1807	2000 x 800	22-39570

### Shelves, for cantilever trolleys

- 15 mm waterproof plywood levels, both sides can be used as side up - one side sealed, one side coated with non-slip surface

Description	Useable depth	Length	Ref. no.
	<i>mm</i>		
double sided use	370	1200	22-39572
		1600	22-39573
		2000	22-39574
single sided use	600	1200	22-39575
		1600	22-39576
		2000	22-39577

### Load retention plates, for cantilever trolleys

- Useful height 30 mm when mounted to standard arms, 27 mm when fitted to arms with PVC sleeve

Description	Ref. no.
load retention plate, to be fitted to the end of each arm	22-39571



## Sheet material stands and trolleys



### Sheet material stands, with 4 rubber feet

- With 4 rubber feet
- Welded steel tube construction, epoxy-coated in brilliant blue, RAL 5007
- Deck from film coated plywood
- 7 fitting positions, clear width between divider bars 90 mm
- Fitted with a full width roller on one short side to help load and unload sheets
- Supplied without divider bars, please order separately, see below



EN 1757-3

Load capacity <i>kg</i>	Platform L x W <i>mm</i>	Ref. no.
1200	1200 x 800	22-21313
1200	1600 x 800	22-21314



### Sheet material trolleys

- Supplied with 2 swivel and 2 fixed castors, swivel castors with brake
- Load capacity 600 kg, wheels with TPE tyres, hub with deep groove ball bearing
- Load capacity 1200 kg, elastic rubber tyred wheels on roller bearing hub
- Deck from film coated plywood
- Welded steel tube construction, epoxy-coated in brilliant blue, RAL 5007
- 7 fitting positions, clear width between divider bars 90 mm
- Supplied without divider bars, please order separately, see below

Load capacity <i>kg</i>	Description	Platform L x W <i>mm</i>	Castor Ø <i>mm</i>	Ref. no.
600	TPE tyres	1200 x 800	200	22-21309
		1600 x 800	200	22-21311
1200	super elastic rubber tyres	1200 x 800	200	22-21310
		1600 x 800	200	22-21312



### Divider bars, for sheet material trolleys and stands

- Steel tube handle, epoxy-coated in brilliant blue, RAL 5007
- Divider bars allow subdivision of loading surface, 7 fitting positions

Length <i>mm</i>	Height <i>mm</i>	Ref. no.
1200	300	22-21315
	600	22-21316
	900	22-21317
1600	300	22-21318
	600	22-21319
	900	22-21320



### Add-on feet for sheet material stands

- Optional accessory
- Set of 4 add-on feet to increase floor clearance to 100 mm for fork lift truck and hand pallet truck handling

Material	Pcs/ pack	Ref. no.
steel	4	22-21321



IN-HOUSE TRANSPORT



## Transport dollies

for containers

**TOP SELLER**

43-21883



Move your bins & containers without effort!

### For containers sized 600 x 400 mm

- Complete with 4 swivel castors
- Designed for European size stacking containers: 1 x 600 x 400 mm or 2 x 400 x 300 mm
- Framework from glassfibre reinforced polyamide

Load capacity	To suit containers sized L x W	Platform L x W	Tyre material	Castor Ø	Ref. no.
<i>kg</i>	<i>mm</i>	<i>mm</i>		<i>mm</i>	
250	600 x 400	620 x 420	rubber	100	43-21883
			PP	100	43-1491

### For containers sized 800 x 600 mm

- Supplied with 2 swivel and 2 fixed castors
- Suited for containers sized 800 x 600 mm
- Made from polypropylene

Load capacity	Height	To suit containers sized L x W	Platform L x W	Tyre material	Castor Ø	Ref. no.
<i>kg</i>	<i>mm</i>	<i>mm</i>	<i>mm</i>		<i>mm</i>	
500	198	800 x 600	800 x 600	polyamide	125	43-1150

### For multi-purpose containers sized 600 x 400 mm

- Complete with 4 swivel castors
- For multi-purpose containers sized 600 x 400 mm
- Fitted with drop-in lid for optimum positioning of MB containers
- Made from glassfibre reinforced polyamide, drop-in lid from polypropylene

Load capacity	To suit containers sized L x W	Tyre material	Castor Ø	Ref. no.
<i>kg</i>	<i>mm</i>		<i>mm</i>	
250	600 x 400	PP	100	6-15510

### For multi-purpose containers sized 800 x 400 mm and 800 x 600 mm

- Complete with 4 swivel castors
- For multi-purpose containers sized 800 x 400 mm and 800 x 600 mm
- Anodised aluminium frame with PVC corner edging
- Supplied unassembled

Load capacity	To suit containers sized L x W	Tyre material	Castor Ø	Ref. no.
<i>kg</i>	<i>mm</i>		<i>mm</i>	
250	800 x 400	PP	100	6-16494
	800 x 600	PP	100	6-19439

Pallet dollies



**Pallet dollies, with TPE tyres, load capacity 500 kg**

- Supplied with 2 swivel castors with brake and 2 fixed castors, wheels with TPE tyre and deep groove ball bearing
- Angled steel framework with support struts, epoxy coated in brilliant blue RAL 5007, without location lugs
- 20 mm upstand on all four sides for safe in-fitting of pallets and mesh box pallets
- **Important note:**
- Additional equipment such as add-on support stand, slot-in push handle, tow bar and coupling cannot be combined with this item!

Load capacity	External dimensions L x W x H	Platform L x W	Castor Ø	Ref. no.
kg	mm	mm	mm	
500	1240 x 830 x 238	1230 x 820	160	22-39558



You will find this option on page 309



**Pallet dollies, with TPE tyres, load capacity 750 kg**

- Supplied with 2 swivel and 2 fixed castors, swivel castors with brake
- Angled steel framework with 4 location lugs, powder coated in brilliant blue, RAL 5007

Load capacity	External dimensions L x W x H	Platform L x W	Wheel dimensions	Ref. no.
kg	mm	mm	mm	
750	855 x 655 x 329	810 x 610	200 x 40	22-43342
	1055 x 855 x 329	1010 x 810	200 x 40	22-43343
	1255 x 855 x 329	1210 x 810	200 x 40	22-21224
	1255 x 1055 x 329	1210 x 1010	200 x 40	22-43344



**Pallet dollies, with polyamide tyres, load capacity 1000 kg**

Load capacity	External dimensions L x W x H	Platform L x W	Wheel dimensions	Ref. no.
kg	mm	mm	mm	
1000	855 x 655 x 329	810 x 610	200 x 50	22-43345
	1055 x 855 x 329	1010 x 810	200 x 50	22-43346
	1255 x 855 x 329	1210 x 810	200 x 50	22-43347
	1255 x 1055 x 329	1210 x 1010	200 x 50	22-43348



**Pallet dollies, with elastic solid rubber tyres, load capacity 1200 kg**

Load capacity	External dimensions L x W x H	Platform L x W	Wheel dimensions	Ref. no.
kg	mm	mm	mm	
1200	855 x 655 x 329	810 x 610	200 x 50	22-43349
	1055 x 855 x 329	1010 x 810	200 x 50	22-43350
	1255 x 855 x 329	1210 x 810	200 x 50	22-21225
	1255 x 1055 x 329	1210 x 1010	200 x 50	22-43351



**Tubular steel push handle, for pallet dollies**

- Optional accessory
- Only for first trolley
- **Can not be retro-fitted, as the handle is permanently welded to the pallet dolly - can only be ordered in conjunction with a pallet dolly**

Material	Ref. no.
steel	22-21226



IN-HOUSE TRANSPORT



## Pallet dollies



### Self-locking push handle, for pallet dollies

- Push-fit handle for pallet dollies at least 800 mm wide
- Extremely robust steel tube construction with solid claw connectors
- Top of bow and cross strut with softgrip coating
- Once hooked off the pallet dolly, the handle can easily be pushed on 2 wheels to its storage place

Material	Ref. no.
steel tube	22-43362

### Add-on support stands, for pallet dollies

- Support allows to place pallets or wire-mesh box pallets in an ergonomically favourable height
- Supplied with bolts to fix legs of support stand to pallet dolly
- For use with pallets sized 1200 x 800 mm



Platform L x W	Max. loading height	Overall height (with support stand fitted)	Load capacity	Ref. no.
<i>mm</i>	<i>mm</i>	<i>mm</i>	<i>kg</i>	
1210 x 810	422	422	1200	22-37791
	552	600	1200	22-37792
	652	652	1200	22-37793

### Tow bar and coupling pin, for pallet dollies

- Suited for a transport speed of up to 6 km/h
- Up to 5 dollies can be tied together
- Flat steel tow bar can be pushed under chassis when not in use
- Solid coupling pin on the fixed castor side
- Trucks/dollies can be linked to each other with a foot operated mechanism
- Max. towing weight 2000 kg
- **Can not be retro-fitted, as the handle is permanently welded to the pallet dolly - can only be ordered in conjunction with a pallet dolly**



Max. towing capacity	Material	Ref. no.
<i>kg</i>		
2000	flat steel profile	22-43361

### Sprung towbar and coupling pin, for pallet dollies

- Suited for a transport speed of up to 6 km/h
- Up to 5 dollies can be tied together
- Flat steel tow bar, gas pressure springs automatically lift tow bar into vertical position when not in use
- Solid coupling pin on the fixed castor side
- Trucks/dollies can be linked to each other with a foot operated mechanism
- Max. towing weight 2000 kg
- **Can not be retro-fitted, as the handle is permanently welded to the pallet dolly - can only be ordered in conjunction with a pallet dolly**



Max. towing capacity	Material	Ref. no.
<i>kg</i>		
2000	flat steel profile	22-43363

## Tipping skips



- Heavy duty welded steel construction made from 3 mm thick steel plate, liquid-tight seams
- Epoxy-coated in brilliant blue, RAL 5007
- Version with drain tap and filter for separating liquids from solids



EN 1757-3

### Roll forward tipping skips

- 2 swivel and 2 fixed castors, swivel castors are supplied with TOTALSTOP central locking system as standard feature, compliant with EN-1757-3
- Load capacity 750 kg, wheels with TPE tyres, hub with deep groove ball bearing
- Load capacity 800 kg, elastic rubber tyred wheels on roller bearing hub
- Body from 2 mm thick steel plate mounted on tilting mechanism
- Double bended top edges, unloading lip folded twice, oil tight welding seams
- Base from 3 mm bended steel sheet profiles with integrated fork entry pockets, kick plate, tipping lock and push handle
- Can be (re-)located on wheels or with a fork lift truck
- Tipping action is released manually
- Wheel diameter 200 mm



Description	Load capacity	External dimensions L x W x H	Filling height	Volume	Ref. no.
	kg				
without drain tap	750	1359 x 713 x 780	780	250	22-39578
	750	1374 x 730 x 1072	733	450	22-39579
	750	1458 x 855 x 1099	843	600	22-39580
	800	1458 x 1105 x 1099	843	800	22-39581
with drain tap	750	1359 x 713 x 780	780	250	22-39582
	750	1374 x 730 x 1072	733	450	22-39583
	750	1458 x 855 x 1099	843	600	22-39584
	800	1458 x 1105 x 1099	843	800	22-39585

### Self-tipping skips

- Designed for handling loose bulk materials; skid-guided self-tipping action
- Do not need lifting for material unloading
- Empty body returns automatically into loading position
- Fitted as standard with fork entry pockets, slide-off and tipping lock, chain for secure fitting to fork truck

Description	Load capacity	External dimensions L x W x H	Filling height	Volume	Ref. no.
	kg				
without drain tap	1000	1294 x 731 x 837	748	350	22-39586
	1500	1294 x 1141 x 837	748	600	22-39587
	2000	1294 x 1661 x 837	748	900	22-39588
	2500	1751 x 1222 x 1127	1043	1200	22-39589
with drain tap	1000	1294 x 731 x 837	748	350	22-39590
	1500	1294 x 1141 x 837	748	600	22-39591
	2000	1294 x 1661 x 837	748	900	22-39592
	2500	1751 x 1222 x 1127	1043	1200	22-39593





## Roller conveyors

- **Modular design allows configurations to requirement**
- **Non-powered in-house transport of goods**
- **Easy to mount, allows immediate adaptation to different locations or needs**
- **Ball-bearing rollers provide very good travel characteristics**

### **i** BITO info

Roller conveyors are ideal for the non-powered in-house transport of plastic bins and containers as well as cardboard boxes. Whether used as push-along conveyor lane for order picking (no incline) or for non-assisted transport to the next workstation (with incline). Mounted onto support stands in front of racking rows in carton live storage environments, roller conveyor tracks allow to have the picking container always in direct reach and in optimum working height.

Free-standing roller tracks with or without incline help you move loads between locations, either by pushing them along or by gravity. Roller tracks are mounted onto twin support stands that can be adjusted to any height (no pitch) to ensure an optimum lane incline.

The incline of 2 - 5% depends on product characteristics and product weight. Due to their modular design, the roller tracks can be mounted quickly and easily and can be adapted without any problem to changing conditions.



### Roller conveyor segments, with plastic rollers

- Please add twin support stands (static or mobile version) to your order
- Other track lengths can be supplied upon request!
- The roller pitch is determined by the length of the smallest unit load. Please note that a unit load must be supported by at least 3 rollers.
- The weight of individual unit loads should not exceed 20-25 kg/unit.
- U-shaped side profiles, galvanised, dimensions 20/70/20 mm

Roller pitch T	Min. length of storage unit	Total width / width				
		Length	340/300 mm	440/400 mm	540/500 mm	640/600 mm
mm	mm	mm	Ref. no.	Ref. no.	Ref. no.	Ref. no.
75	225	975 mm	36-16575	36-16587	36-16599	36-16611
		1500 mm	36-16578	36-16590	36-16602	36-16614
		1950 mm	36-16581	36-16593	36-16605	36-16617
		3000 mm	36-16584	36-16596	36-16608	36-16620
100	300	1000 mm	36-16576	36-16588	36-16600	36-16612
		1500 mm	36-16579	36-16591	36-16603	36-16615
		2000 mm	36-16582	36-16594	36-16606	36-16618
		3000 mm	36-16585	36-16597	36-16609	36-16621
125	375	1000 mm	36-16577	36-16589	36-16601	36-16613
		1500 mm	36-16580	36-16592	36-16604	36-16616
		2000 mm	36-16583	36-16595	36-16607	36-16619
		3000 mm	36-16586	36-16598	36-16610	36-16622





### Bend segments, with plastic rollers

- Please add twin support stands (static or mobile version) to your order
- The roller track width is divided along the track middle line
- Inner curve radius 800 mm, full-width rollers or split rollers depending on track width
- U-shaped side profiles, galvanised, dimensions 20/70/20 mm

Angle	Roller pitch T <i>mm</i>	Total width / width				
		340/300 mm	440/400 mm	540/500 mm	640/600 mm	
		Min. length of storage unit <i>mm</i>	Ref. no.	Ref. no.	Ref. no.	Ref. no.
45°	75	225 mm	36-16720	36-16724	36-16728	36-16732
	125	375 mm	36-16722	36-16726	36-16730	36-16734
90°	75	225 mm	36-16719	36-16723	36-16727	36-16731
	125	375 mm	36-16721	36-16725	36-16729	36-16733



### Lift-up gates, with plastic rollers

Lift-up gate, hinges without spring assistance

Length <i>mm</i>	Description	Total width / width				
		340/300 mm	440/400 mm	540/500 mm	640/600 mm	
		Roller pitch T <i>mm</i>	Ref. no.	Ref. no.	Ref. no.	Ref. no.
1000 mm	hinges without spring assistance	75	36-16671	36-16677	36-16683	36-16689
		100	36-16673	36-16679	36-16685	36-16691
		125	36-16675	36-16681	36-16687	36-16693
	spring-assisted hinges	75	36-16672	36-16678	36-16684	36-16690
		100	36-16674	36-16680	36-16686	36-16692
		125	36-16676	36-16682	36-16688	36-16694



### Roller conveyors



#### Roller conveyor segments, with steel rollers

- Please add twin support stands (static or mobile version) to your order
- The roller pitch is determined by the length of the smallest unit load. Please note that a unit load must be supported by at least 3 rollers.
- Other track lengths can be supplied upon request!
- U-shaped side profiles, galvanised, dimensions 20/70/20 mm

		Total width / width	340/300 mm	440/400 mm	540/500 mm	640/600 mm
Roller pitch T	Min. length of storage unit	Length	Ref. no.	Ref. no.	Ref. no.	Ref. no.
mm	mm	mm				
75	225	975 mm	36-16623	36-16632	36-16641	36-16650
		1500 mm	36-16626	36-16635	36-16644	36-16653
		1950 mm	36-16629	36-16638	36-16647	36-16656
		3000 mm	36-16659	36-16662	36-16665	36-16668
100	300	1000 mm	36-16624	36-16633	36-16642	36-16651
		1500 mm	36-16627	36-16636	36-16645	36-16654
		2000 mm	36-16630	36-16639	36-16648	36-16657
		3000 mm	36-16660	36-16663	36-16666	36-16669
125	375	1000 mm	36-16625	36-16634	36-16643	36-16652
		1500 mm	36-16628	36-16637	36-16646	36-16655
		2000 mm	36-16631	36-16640	36-16649	36-16658
		3000 mm	36-16661	36-16664	36-16667	36-16670



#### Bend segments, with steel rollers

- Please add twin support stands (static or mobile version) to your order
- The roller track width is divided along the track middle line
- Inner curve radius 800 mm, full-width rollers or split rollers depending on track width
- U-shaped side profiles, galvanised, dimensions 20/70/20 mm

		Total width / width	340/300 mm	440/400 mm	540/500 mm	640/600 mm
Angle	Roller pitch T	Min. length of storage unit	Ref. no.	Ref. no.	Ref. no.	Ref. no.
	mm	mm				
45°	75	225 mm	36-16736	36-16740	36-16744	36-16748
	125	375 mm	36-16738	36-16742	36-16746	36-16750
90°	75	225 mm	36-16735	36-16739	36-16743	36-16747
	125	375 mm	36-16737	36-16741	36-16745	36-16749





## Lift-up gates, with steel rollers

Lift-up gate with spring-assisted hinges



Length <i>mm</i>	Description	Total width / width	340/300 mm	440/400 mm	540/500 mm	640/600 mm
		Roller pitch T <i>mm</i>	Ref. no.	Ref. no.	Ref. no.	Ref. no.
1000 mm	hinges without spring assistance	75	36-16695	36-16701	36-16707	36-16713
		100	36-16697	36-16703	36-16709	36-16715
		125	36-16699	36-16705	36-16711	36-16717
	spring-assisted hinges	75	36-16696	36-16702	36-16708	36-16714
		100	36-16698	36-16704	36-16710	36-16716
		125	36-16700	36-16706	36-16712	36-16718

## Twin support stands

- Max. span between two support stands 2000 mm; load capacity 120 kg for 2000 mm spans and 175 kg for spans ≤1500 mm
- Height adjustable insert feet
- Construction height = top edge of roller conveyor
- Painted in sky blue, RAL 5015
- Square tubed construction with swivel hinges



### Twin support stands, without castors

Width	300 mm	400 mm	500 mm	600 mm
Height adjustment range <i>mm</i>	Ref. no.	Ref. no.	Ref. no.	Ref. no.
275 - 340	36-16520	36-16525	36-16530	36-16535
330 - 395	36-16521	36-16526	36-16531	36-16536
390 - 570	36-16522	36-16527	36-16532	36-16537
550 - 850	36-16523	36-16528	36-16533	36-16538
680 - 1100	36-16524	36-16529	36-16534	36-16539

### Twin support stands, mobile version

- Swivel castors with brakes for easy manoeuvring, castor diameter 100 mm

Width	400 mm	500 mm	600 mm
Height adjustment range <i>mm</i>	Ref. no.	Ref. no.	Ref. no.
410 - 465	36-38382	36-38387	36-38392
465 - 525	36-38383	36-38388	36-38393
525 - 680	36-38384	36-38389	36-38394
685 - 920	36-38385	36-38390	36-38395
820 - 1100	36-38386	36-38391	36-38396





### Accessories for roller conveyors with PVC/steel rollers



#### End stop plates, for roller conveyor lanes

- Galvanised steel sheet

Width	300 mm	400 mm	500 mm	600 mm
Material	Ref. no.	Ref. no.	Ref. no.	Ref. no.
zinc-plated steel	36-16546	36-16547	36-16548	36-16549



#### Side capping for track profiles, for roller conveyor lanes

- To be fitted and, where required, cut to size by customer; slots to fit in supports of side railing must be added by customer as necessary

Colour	Ref. no.
black	36-38375



#### Side railing, for straight lanes

- C-profiles, galvanised
- Rail height can be adjusted up to 100 mm
- Please state required length in mm at time of order.

Description	Ref. no.
for straight lanes, single sided use	36-16540
for straight lanes, either side	36-16541

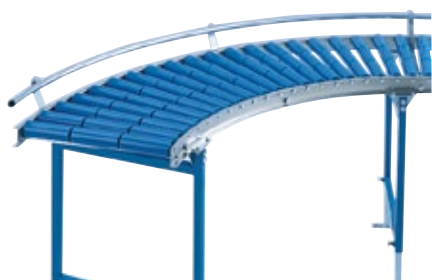

#### Side railing, for bends

- C-profiles, galvanised
- Rail height can be adjusted up to 100 mm

Description	Ref. no.
for 45° bends, outer radius	36-16544
for 45° bends, either side	36-16545
for 90° bends, outer radius	36-16542
for 90° bends, either side	36-16543

## Skatewheel expandaveyors

### **i** BITO info

This standalone, flexible and mobile conveyor system is ideal for all locations with little space and locations which are not suited for floor mounted conveyors.

### Skatewheel expandaveyors

- Can be used in confined spaces
- Extendable to required length
- Legs are height adjustable between 700 and 1100 mm
- Simple to position at required location, locking brakes for safe loading and unloading
- Flexible routing possible for realising narrow bends and S-curves
- All expandaveyor components are galvanised
- Load capacity between two support stands 100 kg



	Width	300 mm	400 mm	500 mm	600 mm
<b>Number of uprights</b>	<b>Extended length</b>	<b>Ref. no.</b>	<b>Ref. no.</b>	<b>Ref. no.</b>	<b>Ref. no.</b>
	<i>mm</i>				
3	1200 - 4400	36-16551	36-16555	36-16559	36-16563
4	1700 - 6200	36-16552	36-16556	36-16560	36-16564
5	2200 - 7900	36-16553	36-16557	36-16561	36-16565
6	2800 - 9600	36-16554	36-16558	36-16562	36-16566

### Track connector units, standard version

- Connect two expandaveyor segments
- Equipped with hooks on either side



	Width	300 mm	400 mm	500 mm	600 mm
<b>Material</b>	<b>Length</b>	<b>Ref. no.</b>	<b>Ref. no.</b>	<b>Ref. no.</b>	<b>Ref. no.</b>
	<i>mm</i>				
zinc-plated steel	400	36-16567	36-16568	36-16569	36-16570

### End stop plates, standard version

- Fixed track end stop
- Prevent goods from falling at track end



	Width	300 mm	400 mm	500 mm	600 mm
<b>Material</b>	<b>Length</b>	<b>Ref. no.</b>	<b>Ref. no.</b>	<b>Ref. no.</b>	<b>Ref. no.</b>
	<i>mm</i>				
zinc-plated steel		36-16571	36-16572	36-16573	36-16574



**Keep tools and equipment easily accessible!**

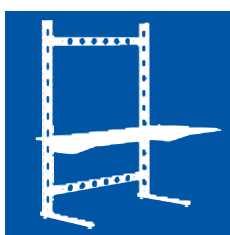

BITO workstation systems are ideally suited for a very wide range of applications in storage, order picking and workshop environments. They assist in creating a professional and productive work environment.

The BITO TEC system is a real allrounder: whether used as functional PC workstation, office desk or packing station with cutter unit, paper dispenser and enough room for storing miscellaneous office equipment, the TEC system helps you stay organised. Of course, later-on reconfigurations are possible to adapt to changing working conditions.

Or are you looking for a heavy duty workbench system? Have a look at our range! We guarantee sturdy, functional and at the same time attractive systems as well as use-alone products.



Contents

**BITO TEC ..... 346**  
**Workbenches ..... 350**



WORKSTATION SYSTEMS



**BITO TEC**

- Professional and functional solution in modern TEC design
- Modular system allows to customise your workstation, later-on extensions are easy to realise
- Framework consisting of a robust steel frame to which desktops and shelf levels can be added to suit your needs
- Worktops are height adjustable on a 60 mm pitch
- Steel components epoxy-coated in aluminium grey, RAL 9007
- Worktops and shelf levels manufactured from chipboard laminate with beech finish

**Workstation frames, single sided use**

External dimensions L x W x H	Worktop/desktop L x W x thickness	Load capacity per desktop/worktop	Ref. no.
<i>mm</i>	<i>mm</i>	<i>kg</i>	
1306 x 920 x 1785	1600 x 800 x 28	150	44-19301
1306 x 920 x 1785	2000 x 800 x 38	250	44-19306

**Workstation frames, double sided use**

External dimensions L x W x H	Worktop/desktop L x W x thickness	Load capacity per desktop/worktop	Ref. no.
<i>mm</i>	<i>mm</i>	<i>kg</i>	
1306 x 1700 x 1785	1600 x 800 x 28	150	44-19302
1306 x 1700 x 1785	2000 x 800 x 38	250	44-19307

**Office desks, single sided use**

External dimensions L x W x H	Worktop/desktop L x W x thickness	Load capacity per desktop/worktop	Ref. no.
<i>mm</i>	<i>mm</i>	<i>kg</i>	
1306 x 620 x 692	1600 x 800 x 28	150	44-19295

## Computer workstation, single sided use

- Framework for single-sided use
- Supplied with 28 mm computer desktop, load capacity 150 kg
- Supplied with straight steel sheet level, 400 mm deep, load capacity 90 kg
- Supplied with inclined shelf steel sheet level, 300 mm deep, load capacity 90 kg
- Delivery does not include mobile pedestal and on-the-side shelving!

External dimensions L x W x H	Worktop/desktop L x W x thickness	Load capacity per desktop/worktop	Ref. no.
<i>mm</i>	<i>mm</i>	<i>kg</i>	
1306 x 920 x 1785	1600 x 800 x 28	150	44-19444



## Computer workstation, sitting and standing use, double sided use

- Framework for double-sided use
- Supplied with 2 computer worktops, load capacity 150 kg, worktops 28 mm thick
- Supplied with straight steel sheet level, 400 mm deep, load capacity 90 kg
- Supplied with 2 inclined shelf steel sheet levels, 300 mm deep, load capacity 90 kg
- Delivery does not include mobile pedestal and on-the-side shelving!

External dimensions L x W x H	Worktop/desktop L x W x thickness	Load capacity per desktop/worktop	Ref. no.
<i>mm</i>	<i>mm</i>	<i>kg</i>	
1306 x 1700 x 1785	1600 x 800 x 28	150	44-19445



## Workstations, single sided use

- Framework for single-sided use
- Supplied with 38 mm worktop, load capacity 250 kg
- Supplied with straight steel sheet level, 400 mm deep, load capacity 90 kg
- Supplied with shelf level with 4 solid sheet dividers, load capacity 100 kg
- Delivery does not include drawer, mandrel kit and cutter unit

External dimensions L x W x H	Worktop/desktop L x W x thickness	Load capacity per desktop/worktop	Ref. no.
<i>mm</i>	<i>mm</i>	<i>kg</i>	
1306 x 920 x 1785	2000 x 800 x 38	250	44-19443



## Workstations, double sided use

- Framework for double-sided use
- Supplied with 2 worktops, load capacity 250 kg, worktops 38 mm thick
- Supplied with 2 shelf levels with 8 solid sheet dividers, load capacity 100 kg
- Delivery does not include drawer, mandrel kit and cutter unit

External dimensions L x W x H	Worktop/desktop L x W x thickness	Load capacity per desktop/worktop	Ref. no.
<i>mm</i>	<i>mm</i>	<i>kg</i>	
1306 x 1700 x 1785	2000 x 800 x 38	250	44-19446



## BITO TEC

### Accessories



**A** Louvered panels suited for wall mounting

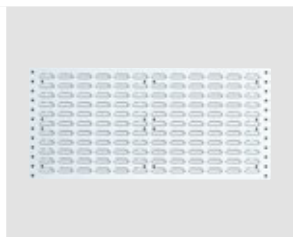

**B** Louvered panels suited for wall and workbench mounting

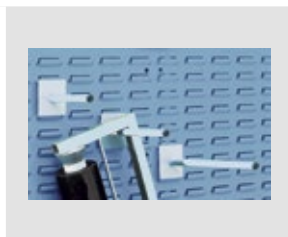

**C** Spigots for louvered panels



**D** Individual drawers



**E** Shelf levels



**F** Shelf levels



**G** Computer desktops



**H** Shelf levels



**I** Worktops



**J** Full sheet dividers

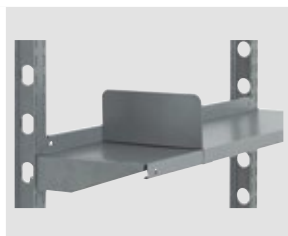

**K** Full sheet dividers



**L** Connector beams



**M** Cutter units



**N** Multi-purpose hanging rails



**O** Add-on feet

Pos.	Description		Dimensions <i>mm</i>	Ref. no.
A	Louvered panels suited for wall mounting	easy-to-mount, hardwearing steel sheet panels, designed to accommodate storage bins SK1095, SK1610 and SK2311	W 457 x H 495	8-14837
B	Louvered panels suited for wall and workbench mounting	reinforcing profiles on the rear, can also be fitted to a desktop, easy-to-mount, hardwearing steel sheet panels, designed to accommodate storage bins SK1095, SK1610 and SK2311	W 1486 x H 457	8-14835
C	Spigots for louvered panels	prong holder for louvered panels	L 150	8-14841
			L 200	8-14842
			L 300	8-14843
D	Individual drawers	painted in light grey, RAL 7035, ball bearing castors, full width aluminium handle integrated with label holder, cylinder lock complete with 2 keys	W 475 x H 128 x D 526	44-15802
E	Shelf levels steel sheet, straight version	steel shelf level with integral retaining lip at rear, supplied with 2 cantilever arms, all parts epoxy-coated in grey aluminium, RAL 9007, load capacity 90 kg	W 1246 x H 98 x D 400	44-19312
			W 1246 x H 98 x D 500	44-19313
F	Shelf levels steel sheet, inclined version	steel shelf level with integral retaining lip at rear, supplied with 2 cantilever arms, 25° slope, all parts epoxy-coated in grey aluminium, RAL 9007, load capacity 90 kg	W 1246 x H 56,8 x D 300	44-19314
			W 1246 x H 56,8 x D 400	44-19315
G	Computer desktops beechwood laminate	28 mm chipboard worktop finished with beech laminate, complete with 2 cantilever arms 600 mm long and fixing material, load capacity 100 kg	L 1600 x W 800	44-19303
H	Shelf levels beechwood laminate	chipboard panel finished with beech laminate, perforated (Ø 7 mm) in 96 mm increments along both long sides for push-in divider adjustment, complete with 2 cantilever arms 400 mm long and fixing material, load capacity 150 kg	L 1600 x W 400	44-19308
I	Worktops	38 mm chipboard worktop finished with beech laminate, complete with 2 cantilever arms 600 mm long and fixing material, load capacity 100 kg	L 2000 x W 800	44-19309
J	Full sheet dividers slot-in fitting	epoxy-coated in grey aluminium, RAL 9007, subdivide shelf level into compartments and allow vertical storage	H 300 x D 300	44-19273
K	Full sheet dividers slide-on fitting	suited for straight shelves, epoxy-coated in grey aluminium, RAL 9007, can be positioned anywhere along the shelf length	H 170 x D 400	44-19289
L	Connector beams type BITO-TEC	epoxy-coated in grey aluminium, RAL 9007, connect 2 columns, 2 connector beams required per bay	L 1246	44-19216
M	Cutter units for paper rolls	clamp-fixed to worktop, cutting width 750 mm	W 750	44-19251
N	Multi-purpose hanging rails	aluminium rail for tool suspension complete with push-along PVC tool hangers, mounting supports, end caps and bolts to fix	L 1500	44-19252
O	Add-on feet	fitted to columns for easy reconfiguration of a single sided structure into a double sided structure, 2 kits required per frame	L 680 x W 50 x H 30	44-19317





## Workbenches



- Modular workbench system can be extended to suit your needs
- Galvanised shelves, load capacity 100 kg
- 30 mm worktops manufactured from beechwood laminate, sealed with several coats of clear, water resistant varnish
- Chamfered edges
- Worktop surface smoothed and treated with linseed oil
- Framework epoxy-coated, only available in gentian blue, RAL 5010



### Workbenches, type 1

	colour	galvanised	RAL 5010 Gentian blue
<b>Description</b>	<b>External dimensions L x W x H</b>	<b>Ref. no.</b>	<b>Ref. no.</b>
	<i>mm</i>		
without worktop	1100 x 624 x 850	10-12670	10-12672
with worktop	1100 x 700 x 880	10-12671	10-12673



### Workbenches, type 2

	colour	galvanised	RAL 5010 Gentian blue
<b>Description</b>	<b>External dimensions L x W x H</b>	<b>Ref. no.</b>	<b>Ref. no.</b>
	<i>mm</i>		
without worktop	2100 x 624 x 850	10-12674	10-12676
with worktop	2100 x 700 x 880	10-12675	10-12677



### Workbenches, type 3

	colour	galvanised	RAL 5010 Gentian blue
<b>Description</b>	<b>External dimensions L x W x H</b>	<b>Ref. no.</b>	<b>Ref. no.</b>
	<i>mm</i>		
with 2-piece worktop	3200 x 700 x 880	10-12679	10-12681
without worktop	3100 x 624 x 850	10-12678	10-12680

**TOP SELLER**

10-12682



### Workbenches, with worktop

- 3 frames
- 6 stiffening beams
- 4 steel shelves
- 25 mm thick multiplex worktop
- Framework galvanised

<b>Description</b>	<b>External dimensions L x W x H</b>	<b>Colour</b>	<b>Ref. no.</b>
	<i>mm</i>		
with worktop	2100 x 700 x 872	galvanised	10-12682

## Accessories



**A** Additional shelves



**B** Rear upstands



**C** Hinged doors



**D** Individual drawers



**E** Drawer blocks



**F** Side cladding for workbenches

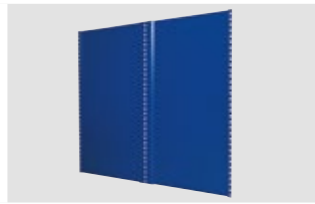

**G** Back cladding for workbenches

Pos.	Description	Colour	Dimensions <i>mm</i>	Ref. no.	
<b>A</b>	Shelf, 40 mm high set includes 4 shelf clips, shelf height 40 mm, with shelf perforations for dividers	galvanised	L 1000 x W 600 x H 40	10-17066	
<b>B</b>	Rear upstands beechwood laminate, worktop with rear upstand, clear height of rear upstand 70 mm, supplied with fixing material	natural colour	W 1094 x H 100	10-6781	
		natural colour	W 2100 x H 100	10-6782	
<b>C</b>	Hinged doors width 1000 mm, can be retro-fitted, all components epoxy-coated in light grey, RAL 7035, supplied with 2 or 3 door pivots, double door with flush fitting turn handle, safety lock and 2 keys (3-point locking mechanism)	RAL 7035 Light grey	W 1000 x H 500	10-29954	
<b>D</b>	Individual drawers painted in light grey, RAL 7035, ball bearing castors, full width aluminium handle integrated with label holder, cylinder lock complete with 2 keys	RAL 7035 Light grey	W 475 x H 128 x D 526	44-15802	
<b>E</b>	Drawer blocks with beams and safety pins, painted in light grey, RAL 7035, useful drawer heights 60/100/140 mm, full width handle with label holder, cylinder lock complete with 2 keys, supplied with cradle for suspension files, load capacity/drawer 80 kg	RAL 7035 Light grey	W 576 x H 425 x D 610	10-15803	
<b>F</b>	Side cladding for workbenches solid steel sheet panel, supplement per frame, supplied pre-assembled, supplied with fixing clips	galvanised	W 600 x H 850	10-15806	
		RAL 5010 Gentian blue	W 600 x H 850	10-15807	
<b>G</b>	Back cladding for workbenches solid steel sheet panel, easy to assemble without bolts, supplied with fixings	galvanised	W 1000 x H 850	14-13060	
		RAL 5010 Gentian blue	W 1000 x H 850	14-13061	



## Workbenches

### Classic Line

WORKSTATION SYSTEMS



- **Sturdy construction from high grade thin sheet metal**
- **Environmentally friendly quality powder coating: framework and housing in anthracite grey RAL 7016, drawer fronts in light grey RAL 7035**
- **Theft-proof central locking mechanism with cylinder lock with 2 keys, also available with combination lock**
- **Full extension drawers on self-closing, ball bearing drawer runners, drawer load capacity 80 kg each, inside drawer dimensions 500 x 450 mm**
- **Supplied with ready-mounted full width aluminium handles**
- **40 mm worktops from beechwood laminate, sealed with several coats of clear, water resistant varnish**
- **Levelling feet with glides to cope with uneven floors**
- **Other configurations and drawer divider kits upon request**



### Cabinet workbenches, Classic Line, width 1500 mm

- Supplied ready-mounted for immediate use

Description	Height	Depth	Worktop thickness	Load capacity	Ref. no.
	<i>mm</i>	<i>mm</i>	<i>mm</i>	<i>kg</i>	
left: 1 half-length shelf / right: 4 drawers, 1 x 75 mm, 1 x 100 mm, 1 x 150 mm, 1 x 175 mm	960	600	40	800	15-45580



### Cabinet workbenches, Classic Line, width 1500 mm

- Supplied ready-mounted for immediate use

Description	Height	Depth	Worktop thickness	Load capacity	Ref. no.
	<i>mm</i>	<i>mm</i>	<i>mm</i>	<i>kg</i>	
left: 4 drawers, 1 x 75 mm, 1 x 100 mm, 1 x 150 mm, 1 x 175 mm / right: 4 drawers, 1 x 75 mm, 1 x 100 mm, 1 x 150 mm, 1 x 175 mm	960	600	40	800	15-45581



### Cabinet workbenches, Classic Line, width 2000 mm

- Supplied ready-mounted for immediate use

Description	Height	Depth	Worktop thickness	Load capacity	Ref. no.
	<i>mm</i>	<i>mm</i>	<i>mm</i>	<i>kg</i>	
left: 1 half-length shelf / right: 4 drawers, 1 x 75 mm, 1 x 100 mm, 1 x 150 mm, 1 x 175 mm	960	600	40	800	15-45582

### Cabinet workbenches, Classic Line, width 2000 mm

■ Supplied ready-mounted for immediate use

Description	Height	Depth	Worktop thickness	Load capacity	Ref. no.
	<i>mm</i>	<i>mm</i>	<i>mm</i>	<i>kg</i>	
left: 4 drawers, 1 x 75 mm, 1 x 100 mm, 1 x 150 mm, 1 x 175 mm / middle: 1 half-depth shelf / right: 4 drawers, 1 x 75 mm, 1 x 100 mm, 1 x 150 mm, 1 x 175 mm	960	600	40	800	15-45583

**TOP SELLER**

15-45583



### Cabinet workbenches, Classic Line, width 2000 mm

■ Supplied ready-mounted for immediate use

Description	Height	Depth	Worktop thickness	Load capacity	Ref. no.
	<i>mm</i>	<i>mm</i>	<i>mm</i>	<i>kg</i>	
left: 3 drawers, 2 x 150 mm, 1 x 200 mm / middle: 4 drawers, 2 x 100 mm, 2 x 150 mm / right: 1 hinged door 500 mm	960	600	40	800	15-45584



### Cabinet workbenches, Classic Line, width 2000 mm

■ Supplied ready-mounted for immediate use

Description	Height	Depth	Worktop thickness	Load capacity	Ref. no.
	<i>mm</i>	<i>mm</i>	<i>mm</i>	<i>kg</i>	
left: 4 drawers, 2 x 100 mm, 2 x 150 mm / middle: 3 drawers, 2 x 150 mm, 1 x 200 mm / right: 4 drawers, 2 x 100 mm, 2 x 150 mm	960	600	40	800	15-45585



### Modular workbenches, Classic Line, width 2000 mm, 2 drawer blocks, width 600 mm each

■ Supplied unassembled to allow building custom workbenches

Description	Height	Depth	Worktop thickness	Load capacity	Ref. no.
	<i>mm</i>	<i>mm</i>	<i>mm</i>	<i>kg</i>	
left: 7 drawers 100 mm / right: 5 drawers, 1 x 50 mm, 3 x 150 mm, 1 x 200 mm	860	600	40	1500	15-45587
left: 8 drawers 100 mm / right: 6 drawers, 1 x 50 mm, 1 x 100 mm, 3 x 150 mm, 1 x 200 mm	960	600	40	800	15-45586



Ref.no. 15-45586





### Workbenches

#### Classic Line



#### Modular workbenches, Classic Line, width 2000 mm, 1 drawer block, width 700 mm

- Supplied unassembled to allow building custom workbenches
- Inside drawer dimensions 600 x 450 mm

Description	Height	Depth	Worktop thickness	Load capacity	Ref. no.
	<i>mm</i>	<i>mm</i>	<i>mm</i>	<i>kg</i>	
left: square tubed framework / right: 7 drawers 100 mm	860	600	40	1000	15-45588



#### Mobile workbenches, Classic Line, width 1300 mm

- Supplied ready-mounted for immediate use

Description	Height	Depth	Worktop thickness	Load capacity	Ref. no.
	<i>mm</i>	<i>mm</i>	<i>mm</i>	<i>kg</i>	
4 swivel castors Ø 125 mm, 2 with brake / left: 2 laminate shelf levels 600 x 570 x 25 mm / right: 4 drawers, 2 x 100 mm, 2 x 150 mm	960	600	25	400	15-45589

WORKSTATION SYSTEMS

#### **i** BITO info

Add-ons and accessories upon request.





## Workbenches

### Premium Line

- Robust construction from square tubed profiles sized 40 x 40 x 2 mm, housing from high grade thin sheet metal, workbench load capacity of up to 1000 kg
- Supplied ready-mounted for immediate use
- Environmentally friendly quality powder coating: framework and housing in light grey RAL 7035, drawer fronts in light blue RAL 5012
- Theft-proof central locking mechanism with cylinder lock with 2 keys, also available with combination lock
- Full extension drawers on ball bearing drawer runners, drawers with a front height of 50 mm have a load capacity of 50 kg, 100 kg for drawers with a front height of 75 mm or more and 180 kg for drawers with a front height of 100 mm or more
- Drawer dividers on [www.shop.bitto.com](http://www.shop.bitto.com)
- 40 mm worktops from beechwood laminate, sealed with several coats of clear, water resistant varnish
- Levelling feet with glides to cope with uneven floors



### Cabinet workbenches, Premium Line, width 1500/2000 mm

- Inside drawer dimensions 450 x 600 mm

Description	Width	Height	Depth	Worktop thickness	Load capacity	Ref. no.
	<i>mm</i>	<i>mm</i>	<i>mm</i>	<i>mm</i>	<i>kg</i>	
left: 1 half-length shelf / right: 3 drawers, 3 x 200 mm	1500	859	750	40	1000	15-45590
	2000	859	750	40	1000	15-45591



### Cabinet workbenches, Premium Line, width 1500 mm

- Inside drawer dimensions 600 x 600 mm

Description	Height	Depth	Worktop thickness	Load capacity	Ref. no.
	<i>mm</i>	<i>mm</i>	<i>mm</i>	<i>kg</i>	
left: 4 drawers, 2 x 100 mm, 2 x 200 mm / right: 1 door 600 mm, 1 shelf level	859	750	40	1000	15-45592



### Cabinet workbenches, Premium Line, width 1500 mm

- Inside drawer dimensions 600 x 600 mm

Description	Height	Depth	Worktop thickness	Load capacity	Ref. no.
	<i>mm</i>	<i>mm</i>	<i>mm</i>	<i>kg</i>	
left: 3 drawers, 3 x 200 mm / right: 4 drawers, 4 x 150 mm	859	750	40	1000	15-45593





### Workbenches

#### Premium Line



#### Cabinet workbenches, Premium Line, width 1500 mm

■ Inside drawer dimensions 450 x 600 mm

Description	Height	Depth	Worktop thickness	Load Capacity	Ref. no.
	<i>mm</i>	<i>mm</i>	<i>mm</i>	<i>kg</i>	
left: 3 drawers, 3 x 200 mm / right: 3 drawers, 3 x 200 mm	859	750	40	1000	15-45594



#### Cabinet workbenches, Premium Line, width 2000 mm

■ Inside drawer dimensions 450 x 600 mm

Description	Height	Depth	Worktop thickness	Load Capacity	Ref. no.
	<i>mm</i>	<i>mm</i>	<i>mm</i>	<i>kg</i>	
left: 4 drawers, 1 x 50 mm, 1 x 150 mm, 2 x 200 mm / right: 1 drawer, 1 x 150 mm, 1 x door 450 mm	859	750	40	1000	15-45595



#### Cabinet workbenches, Premium Line, width 2000 mm

■ Inside drawer dimensions 450 x 600 mm

Description	Height	Depth	Worktop thickness	Load Capacity	Ref. no.
	<i>mm</i>	<i>mm</i>	<i>mm</i>	<i>kg</i>	
left: 3 drawers, 3 x 200 mm / right: 3 drawers, 3 x 200 mm	859	750	40	1000	15-45596

**TOP SELLER** !

15-45597



#### Cabinet workbenches, Premium Line, width 2000 mm

■ Inside drawer dimensions 600 x 600 mm

Description	Height	Depth	Worktop thickness	Load Capacity	Ref. no.
	<i>mm</i>	<i>mm</i>	<i>mm</i>	<i>kg</i>	
left: 3 drawers, 3 x 200 mm / middle: 2 shelves 300 mm / right: 4 drawers, 4 x 150 mm	859	750	40	1000	15-45597

**Cabinet workbenches, Premium Line, width 2000 mm**

■ Inside drawer dimensions 450 x 600 mm

Description	Height	Depth	Worktop thickness	Load Capacity	Ref. no.
	<i>mm</i>	<i>mm</i>	<i>mm</i>	<i>kg</i>	
left: 5 drawers, 3 x 100 mm, 2 x 150 mm / middle: 3 drawers, 3 x 200 mm / right: 4 drawers, 2 x 75 mm, 1 x 150 mm, 1 x 300 mm	859	750	40	1000	15-45598



**Cabinet workbenches, Premium Line, width 2500 mm**

■ Inside drawer dimensions 450 x 600 mm

Description	Height	Depth	Worktop thickness	Load Capacity	Ref. no.
	<i>mm</i>	<i>mm</i>	<i>mm</i>	<i>kg</i>	
left end: 1 door 600 mm, 1 x shelf / middle left: 5 drawers, 1 x 50 mm, 1 x 100 mm, 3 x 150 mm / middle right: 3 drawers, 3 x 200 mm / right end: 2 drawers, 2 x 300 mm	859	750	40	1000	15-45599



WORKSTATION SYSTEMS

**i BITO info**  
Add-ons and accessories upon request.





**Designed for neat and tidy storage!**



The following pages will guide you through our range of high-quality steel sheet cabinets and cupboards for use in industrial and commercial environments.

The range stretches from cupboards providing many options for subdivision with shelves, partitions and compartments over multi-purpose cupboards fitted with sliding or clear view doors, storage benches in many variations to garment lockers and cloakroom units.

Some products are available with up to 25 colour combinations without supplement!



Contents

- Utility cupboards .....360
- Cabinets & Cupboards.....364
- Janitorial, garment and file lockers .....368
- Cabinets for environmentally hazardous goods ..370
- Utility cupboards with sliding doors .....371
- Cube lockers.....374
- Garment lockers.....376
- Z-fronted wardrobes.....378
- Cloakroom bench seats .....379
- Drawer cabinets .....380



**Utility cupboards**

with hinged double door, 110° opening angle

- Strong steel construction with scratch resistant and UV resistant coating
- Reinforced doors provide extra strength
- Flush-fitting round grip operating a three point locking mechanism, complete with 2 keys
- Shelf load capacity 50 kg, shelf levels can be adjusted in height, galvanised finish
- Competitively priced all-purpose cupboard from high quality steel - a must-have for storage areas, workshops or offices



CABINETS &amp; CUPBOARDS



**TOP SELLER** !  
13-20057

**With hinged double door, 110° opening angle**

Colour housing	Colour doors	Width <i>mm</i>	Height <i>mm</i>	Depth <i>mm</i>	Number of shelves	Number of doors	Ref. no.
RAL 7035 Light grey	RAL 5012 Light blue	940	1950	400	4	2	13-38400
	RAL 7035 Light grey	940	1950	400	4	2	13-20057
Shelf levels	galvanised	925	24	352	1		13-20437

## Utility cupboards

with hinged double door, 110° opening angle

- Strong steel construction with scratch resistant and UV resistant coating
- Reinforced doors provide extra strength
- Excellent wear and tear resistance and user friendliness, easy-to-operate Ergo-Lock with handle, cylinder lock and 2 keys (3-point locking mechanism)
- Shelf load capacity 70 kg, shelf levels are adjustable on a 15 mm pitch, galvanised finish
- Integral plastic glide feet protect floors and cabinets
- Housing and doors painted in light grey, RAL 7035

### **i** BITO info

Please specify at time of order:

Colour HOUSING: RAL ...

Colour DOORS: RAL ...

**RAL 5010** **RAL 3000** **RAL 5012** **RAL 7016** **RAL 7035**

The indicated RAL colours for housing and doors can be combined to your choice.

Orders without colour specification will be supplied in light grey, RAL 7035.



3-point lock



### With hinged double door, 110° opening angle

Dimensions W x H	Depth	Number of shelves	Number of doors	Ref. no.
mm	mm			
500 x 1950	400	4	1	13-20722
	500	4	1	13-20724
700 x 1950	400	4	2	13-20726
	500	4	2	13-20728
930 x 1950	400	4	2	13-20474
	500	4	2	13-20476
	600	4	2	13-20478
	800	4	2	13-47770
1200 x 1950	400	4	2	13-20480
	500	4	2	13-20482
	600	4	2	13-20484
	800	4	2	13-47772

### Accessories

Description		Suited for a cabinet depth of	Suited for a cabinet width of	Load cap. per shelf level	Ref. no.	
				kg		
Shelf levels	durable steel construction, supplied with 4 shelf clips	400	500	70	13-20723	
			700	70	13-20727	
			930	70	13-20475	
			1200	70	13-20481	
		500	500	70	13-20725	
			700	70	13-20729	
			930	70	13-20477	
			1200	70	13-20483	
		600	930	70	13-20479	
			1200	70	13-20485	
			800	930	70	13-47771
				1200	70	13-47773
extra deep for bulky goods, durable steel construction, supplied with 4 shelf clips		800	930	70	13-47771	
			1200	70	13-47773	





## Utility cupboards

with hinged double door, 180° opening angle, suited for high load capacities

- Strong steel construction with scratch resistant and UV resistant coating
- Reinforced doors provide extra strength
- Excellent wear and tear resistance and user friendliness, easy-to-operate Ergo-Lock with handle, cylinder lock and 2 keys (3-point locking mechanism)
- Heavy duty shelf with a load capacity of 110 kg, shelf levels are adjustable on a 15 mm pitch, load capacity of cupboard 700 kg
- Integral plastic glide feet protect floors and cabinets
- Housing and doors painted in light grey, RAL 7035

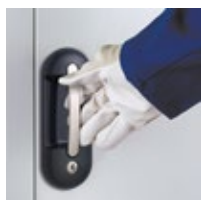

3-point lock

### i BITO info

Please specify at time of order:

Colour HOUSING: RAL ...

Colour DOORS: RAL ...

**RAL 5010** **RAL 3000** **RAL 5012** **RAL 7016** **RAL 7035**

The indicated RAL colours for housing and doors can be combined to your choice.

Orders without colour specification will be supplied in light grey, RAL 7035.

### With hinged double door, 180° opening angle, suited for high load capacities

Dimensions W x H	Depth	Number of shelves	Number of doors	Ref. no.
<i>mm</i>	<i>mm</i>			
500 x 1950	400	4	1	13-47803
	500	4	1	13-47804
930 x 1950	400	4	2	13-47805
	500	4	2	13-47806
	600	4	2	13-47807
	800	4	2	13-47808
1200 x 1950	400	4	2	13-47809
	500	4	2	13-47810
	600	4	2	13-47811
	800	4	2	13-47812

### Accessories



Description		Suited for a cabinet depth of	Suited for a cabinet width of	Load cap. per shelf level	Ref. no.
				<i>kg</i>	
Shelf levels	durable steel construction, supplied with 4 shelf clips	400	500	110	13-47813
			930	110	13-47815
			1200	110	13-47819
		500	500	110	13-47814
			930	110	13-47816
			1200	110	13-47820
		600	930	110	13-47817
			1200	110	13-47821
		800	930	110	13-47818
			1200	110	13-47822

## Utility cupboards

with hinged double door, 180° opening angle, and viewing windows

- Strong steel construction with scratch resistant and UV resistant coating
- Save time and money - doors with 3 mm acrylic glass windows allow immediate product identification
- Reinforced doors provide extra strength, concealed locking bars
- Excellent wear and tear resistance and user friendliness, easy-to-operate Ergo-Lock with handle, cylinder lock and 2 keys (3-point locking mechanism)
- Shelf load capacity 70 kg, shelf levels are adjustable on a 15 mm pitch, galvanised finish
- Integral plastic glide feet protect floors and cabinets
- Housing and doors painted in light grey, RAL 7035

### i BITO info

Please specify at time of order:

Colour HOUSING: RAL ...

Colour DOORS: RAL ...

**RAL 5010** **RAL 3000** **RAL 5012** **RAL 7016** **RAL 7035**

The indicated RAL colours for housing and doors can be combined to your choice.

Orders without colour specification will be supplied in light grey, RAL 7035.



3-point lock



## With hinged double door, 180° opening angle, and viewing windows

Dimensions W x H <i>mm</i>	Depth <i>mm</i>	Number of shelves	Number of doors	Ref. no.
500 x 1950	400	4	1	13-47833
	500	4	1	13-47834
700 x 1950	400	4	2	13-47835
	500	4	2	13-47836
930 x 1950	400	4	2	13-47837
	500	4	2	13-47838
	600	4	2	13-47839
	800	4	2	13-47840
1200 x 1950	400	4	2	13-47841
	500	4	2	13-47842
	600	4	2	13-47843
	800	4	2	13-47844

### Accessories

Description		Suited for a cabinet depth of	Suited for a cabinet width of	Load cap. per shelf level <i>kg</i>	Ref. no.
Shelf levels	durable steel construction, supplied with 4 shelf clips	400	500	70	13-20723
			700	70	13-20727
			930	70	13-20475
			1200	70	13-20481
		500	500	70	13-20725
			700	70	13-20729
			930	70	13-20477
			1200	70	13-20483
		600	930	70	13-20479
			1200	70	13-20485
			800	930	70
	1200	70		13-47773	
	extra deep for bulky goods, durable steel construction, supplied with 4 shelf clips				



## Cabinets & Cupboards

with hinged double door, 110° opening angle, and bins



3-point lock

For highest demands in trade and industry!

- Strong steel construction with scratch resistant and UV resistant coating
- Reinforced doors provide extra strength
- Excellent wear and tear resistance and user friendliness, easy-to-operate Ergo-Lock with handle, cylinder lock and 2 keys (3-point locking mechanism)
- Shelf load capacity 70 kg, shelf levels are adjustable on a 15 mm pitch, galvanised finish
- Integral plastic glide feet protect floors and cabinets
- Housing and doors painted in light grey, RAL 7035, other colour combinations on request

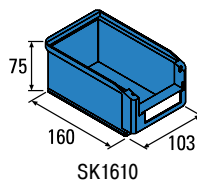

SK1610

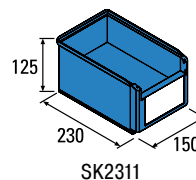

SK2311

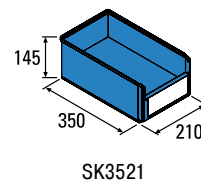

SK3521

### With hinged double door, 110° opening angle, and bins

- Shelf load capacity 70 kg

External dimensions W x H x D	Number of shelves	Number of containers	Features	Ref. no.
<i>mm</i>				
700 x 1690 x 300	11	60	36 x SK1610 red (160 x 103 x 75 mm) 24 x SK2311 blue (230 x 150 x 125 mm)	13-20461



### With hinged double door, 110° opening angle, and bins

- Shelf load capacity 70 kg

External dimensions W x H x D	Number of shelves	Number of containers	Features	Ref. no.
<i>mm</i>				
700 x 1690 x 300	14	90	42 x SK1610 red (160 x 103 x 75 mm) 48 x SK1610 blue (160 x 103 x 75 mm)	13-20460



More accessories from page 23

**With hinged double door, 110° opening angle, and bins**

■ Shelf load capacity 70 kg

External dimensions W x H x D	Number of shelves	Number of containers	Features	Ref. no.
<i>mm</i> 1000 x 1980 x 420	11	72	48 x RK3109 blue (300 x 117 x 90 mm) 12 x SK3521 red (350 x 210 x 145 mm) 12 x SK3521 blue (350 x 210 x 145 mm)	13-20466

**With hinged double door, 110° opening angle, and bins**

■ Shelf load capacity 70 kg

External dimensions W x H x D	Number of shelves	Number of containers	Features	Ref. no.
<i>mm</i> 1000 x 1980 x 420	9	40	20 x SK3521 red (350 x 210 x 145 mm) 20 x SK3521 blue (350 x 210 x 145 mm)	13-20465

**With hinged double door, 110° opening angle, and bins**

■ Shelf load capacity 70 kg

External dimensions W x H x D	Number of shelves	Number of containers	Features	Ref. no.
<i>mm</i> 1000 x 1980 x 420	12	72	40 x RK3109 blue (300 x 117 x 90 mm) 16 x RK3209 blue (300 x 234 x 90 mm) 16 x RK3214 blue (300 x 234 x 140 mm)	13-20467





## Cabinets & Cupboards

with hinged double door, 180° opening angle, drawers and bins



3-point lock

Plenty of room for small parts and components

- Strong steel construction with scratch resistant and UV resistant coating
- 2 doors on exterior door hinges, 180° opening, doors reinforced for extra strength
- Excellent wear and tear resistance and user friendliness, easy-to-operate Ergo-Lock with handle, cylinder lock and 2 keys (3-point locking mechanism)
- Shelf load capacity 70 kg, load capacity of short shelves 50 kg, shelf levels are adjustable on a 15 mm pitch, drawer load capacity approx. 50 kg, galvanised finish
- Integral plastic glide feet protect floors and cabinets
- Reinforced doors with integrated louvre panel provide additional storage space
- Fitted with practical storage bins with pick opening providing excellent product visibility and convenient handling
- Housing and doors painted in light grey, RAL 7035, other colour combinations on request

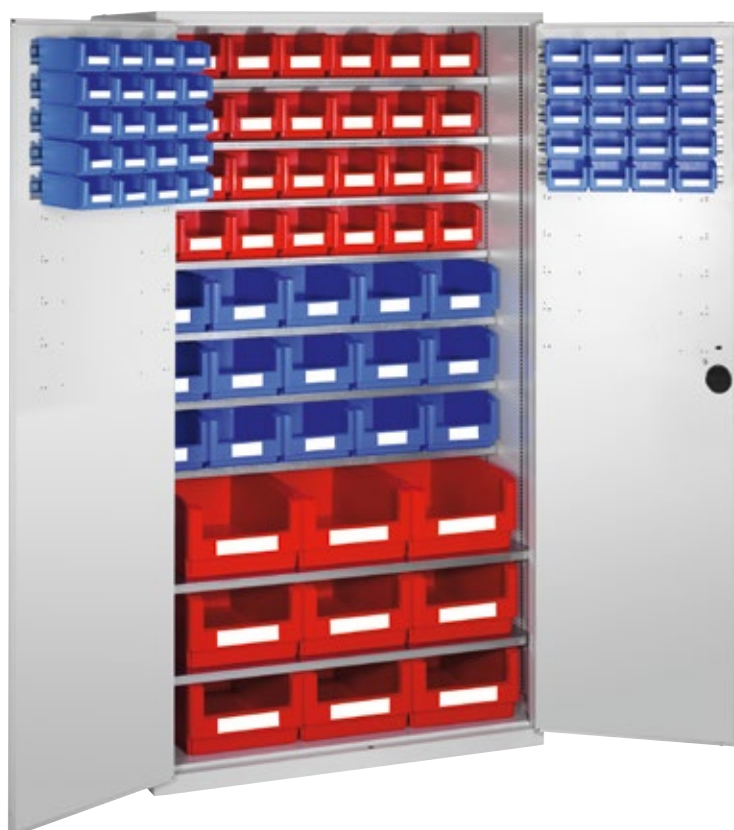

**TOP SELLER**

13-20462

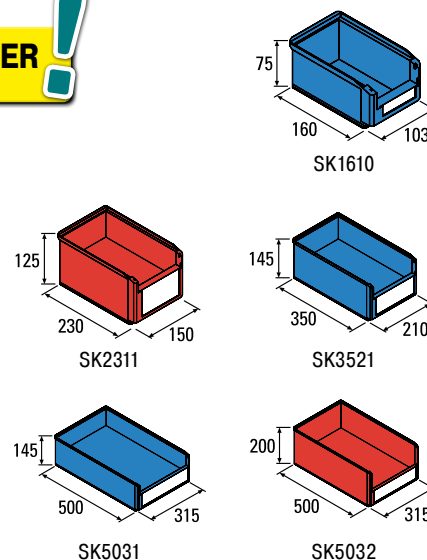

With hinged double door, 180° opening angle, and bins

External dimensions W x H x D	Number of shelves	Number of containers	Features	Ref. no.
<i>mm</i> 1100 x 1950 x 535	9	92	40 x SK1610 blue (160 x 103 x 75 mm) 28 x SK2311 red (230 x 150 x 125 mm) 15 x SK3521 blue (250 x 210 x 145 mm) 9 x SK5032 red (500 x 315 x 200 mm)	13-20462



More accessories from page 23

**With hinged double door, 180° opening angle, and bins**

External dimensions W x H x D	Number of shelves	Number of containers	Features	Ref. no.
<i>mm</i> 1100 x 1950 x 535	9	106	56 x SK1610 red (160 x 103 x 75 mm) 35 x SK2311 blue (230 x 150 x 125 mm) 6 x SK5031 red (500 x 315 x 145 mm) 9 x SK5032 blue (500 x 315 x 200 mm)	13-20463

**With hinged double door, 180° opening angle, drawers and bins**

External dimensions W x H x D	Number of shelves	Number of containers	Features	Ref. no.
<i>mm</i> 1100 x 1950 x 535	7	83	3 telescopic drawers 40 x SK1610 blue (160 x 103 x 75 mm) 28 x SK2311 red (230 x 150 x 125 mm) 15 x SK3521 blue (250 x 210 x 145 mm)	13-20468

**With hinged double door, 180° opening angle, drawers and bins**

External dimensions W x H x D	Number of shelves	Number of containers	Features	Ref. no.
<i>mm</i> 1100 x 1950 x 535	7	97	3 telescopic drawers 56 x SK1610 red (160 x 103 x 75 mm) 35 x SK2311 blue (230 x 150 x 125 mm) 6 x SK5031 red (500 x 315 x 145 mm)	13-20469



## Janitorial, garment and file lockers

with hinged double door, 110° opening angle



- Strong steel construction with scratch resistant and UV resistant powder coating
- Cylinder lock complete with 2 keys that lock both doors for secure storage

### i BITO info

**Please specify at time of order:**

Colour HOUSING: RAL ...

Colour DOORS: RAL ...

**RAL 5010** **RAL 3000** **RAL 5012** **RAL 7016** **RAL 7035**

The indicated RAL colours for housing and doors can be combined to your choice.

Orders without colour specification will be supplied in light grey, RAL 7035.

### Janitorial lockers, with hinged double door, 110° opening angle

- Reduced height centre partition
- Left side: 3 fitted shelves (= 4 tiers)
- Right side: full height compartment with 1 garment rail and 3 push-along hooks
- Smooth and snag-free surfaces allow easy cleaning
- Doors louvres to provide air ventilation

Dimensions W x H x D	Number of doors	Ref. no.
<i>mm</i>		
600 x 1850 x 500	2	13-35733



### Janitorial lockers, with hinged double door, 110° opening angle

- Full height partition
- Left side: 5 height adjustable shelves for optimum use of space
- Right side: 1 adjustable shelf, 1 garment rail and 3 push-along hooks
- Smooth and snag-free surfaces allow easy cleaning

Dimensions W x H x D	Number of doors	Ref. no.
<i>mm</i>		
1000 x 1950 x 500	2	13-35734
1000 x 1950 x 600	2	13-35735

### Garment lockers/File lockers, with hinged double door, 110° opening angle

- Full height centre partition
- Left side: 4 fitted shelves
- Right side: 1 fitted shelf, 1 garment rail and 3 push-along hooks
- Smooth and snag-free surfaces allow easy cleaning
- Doors louvres to provide air ventilation

Dimensions W x H x D <i>mm</i>	Number of doors	Ref. no.
600 x 1850 x 500	2	13-35730



### Garment lockers/File lockers, with hinged double door, 110° opening angle

- Full width fitted hat shelf on top, centre partition underneath
- Left side: 3 height adjustable shelves for optimum use of space
- Right side: 1 garment rail and 3 push-along hooks
- Smooth and snag-free surfaces allow easy cleaning

Dimensions W x H x D <i>mm</i>	Number of doors	Ref. no.
1000 x 1950 x 500	2	13-35731
1000 x 1950 x 600	2	13-35732





## Cabinets for environmentally hazardous goods

with hinged double door, 110° opening angle

- Strong steel construction with scratch resistant and UV resistant coating
- Professional storage of fertilizers, oils, fats, small amounts of diluents etc. (not suited for acids or alkalis) to avoid high costs of dealing with leak damage
- Spill trays with leak-tight welded seams in compliance with the relevant safety regulations
- Doors louvres to provide air ventilation
- Reinforced doors provide extra strength
- Excellent wear and tear resistance and user friendliness, easy-to-operate Ergo-Lock with handle, cylinder lock and 2 keys (3-point locking mechanism)
- Load capacity per tray shelf 80 kg, shelf levels are height adjustable on a 15 mm pitch
- Integral plastic glide feet protect floors and cabinets
- Housing and doors painted in light grey, RAL 7035, other colour combinations on request



3-point lock

### With hinged double door, 110° opening angle, and galvanised shelf levels

Dimensions W x H	Depth	Number of tray shelves	Number of doors	Ref. no.
<i>mm</i>	<i>mm</i>			
500 x 1950	500	4	1	13-47855
930 x 1950	500	4	2	13-47856



### With hinged double door, 110° opening angle, and polythylene shelf levels

Dimensions W x H	Depth	Number of tray shelves	Number of doors	Ref. no.
<i>mm</i>	<i>mm</i>			
500 x 1950	500	4	1	13-47857
930 x 1950	500	4	2	13-47858

## Utility cupboards

with sliding doors

- Strong steel construction with scratch resistant and UV resistant coating
- Ideal if space is limited, since sliding doors do not need extra space to open
- Smooth-running sliding doors on special rail-guided rollers
- Ergonomic metal handles, central locking mechanism with lock-down cylinder lock and 2 keys
- Shelf load capacity 70 kg, shelf levels are adjustable on a 15 mm pitch, galvanised finish
- Integral plastic glide feet protect floors and cabinets
- Housing and doors painted in light grey, RAL 7035

### **i** BITO info

Please specify at time of order:

Colour HOUSING: RAL ...

Colour DOORS: RAL ...

**RAL 5010** **RAL 3000** **RAL 5012** **RAL 7016** **RAL 7035**

The indicated RAL colours for housing and doors can be combined to your choice.

Orders without colour specification will be supplied in light grey, RAL 7035.



### With sliding doors

Dimensions W x H	Depth	Number of shelves	Number of doors	Ref. no.
<i>mm</i>	<i>mm</i>			
1200 x 1950	400	4	2	13-47869
	500	4	2	13-47870
	600	4	2	13-47871
1600 x 1950	400	2 x 4	2	13-47872
	500	2 x 4	2	13-47873
	600	2 x 4	2	13-47874

### Accessories

Description		Suited for a cabinet depth of	Suited for a cabinet width of	Load cap. per shelf level	Ref. no.
				<i>kg</i>	
Shelf levels	durable steel construction, supplied with 4 shelf clips	400	1200	70	13-47875
			1600	70	13-47878
		500	1200	70	13-47876
			1600	70	13-47879
		600	1200	70	13-47877
			1600	70	13-47880



## Utility cupboards

with heavy duty sliding doors

CABINETS & CUPBOARDS



- Strong steel construction with scratch resistant and UV resistant coating
- Ideal if space is limited, since sliding doors do not need extra space to open
- Smooth-running sliding doors on special rail-guided rollers
- Ergonomic metal handles, central locking mechanism with lock-down cylinder lock and 2 keys
- Heavy duty shelf with a load capacity of 110 kg, shelf levels are adjustable on a 15 mm pitch, load capacity of cupboard 700 kg
- Integral plastic glide feet protect floors and cabinets
- Housing and doors painted in light grey, RAL 7035

### i BITO info

Please specify at time of order:

Colour HOUSING: RAL ...

Colour DOORS: RAL ...

**RAL 5010** **RAL 3000** **RAL 5012** **RAL 7016** **RAL 7035**

The indicated RAL colours for housing and doors can be combined to your choice.

Orders without colour specification will be supplied in light grey, RAL 7035.

### With heavy duty sliding doors

Dimensions W x H	Depth	Number of shelves	Number of doors	Ref. no.
<i>mm</i>	<i>mm</i>			
1200 x 1950	500	4	2	13-47905
1600 x 1950	500	2 x 4	2	13-47906

### Accessories



Description		Suited for a cabinet depth of	Suited for a cabinet width of	Load cap. per shelf level	Ref. no.
				<i>kg</i>	
Shelf levels	durable steel construction, supplied with 4 shelf clips	500	1200	110	13-47907
			1600	110	13-47908

## Utility cupboards

with sliding doors and windows

- Strong steel construction with scratch resistant and UV resistant coating
- Ideal if space is limited, since sliding doors do not need extra space to open
- Save time and money - doors with 3 mm acrylic glass windows allow immediate product identification
- Smooth-running sliding doors on special rail-guided rollers
- Ergonomic metal handles, central locking mechanism with lock-down cylinder lock and 2 keys
- Shelf load capacity 70 kg, shelf levels are adjustable on a 15 mm pitch, galvanised finish
- Integral plastic glide feet protect floors and cabinets
- Housing and doors painted in light grey, RAL 7035

### **i** BITO info

Please specify at time of order:

Colour HOUSING: RAL ...

Colour DOORS: RAL ...

**RAL 5010** **RAL 3000** **RAL 5012** **RAL 7016** **RAL 7035**

The indicated RAL colours for housing and doors can be combined to your choice.

Orders without colour specification will be supplied in light grey, RAL 7035.



CABINETS & CUPBOARDS

### With sliding doors and windows

Dimensions W x H	Depth	Number of shelves	Number of doors	Ref. no.
<i>mm</i>	<i>mm</i>			
1200 x 1950	400	4	2	13-47913
	500	4	2	13-47914
	600	4	2	13-47915
1600 x 1950	400	2 x 4	2	13-47916
	500	2 x 4	2	13-47917
	600	2 x 4	2	13-47918

### Accessories

Description		Suited for a cabinet depth of	Suited for a cabinet width of	Load cap. per shelf level	Ref. no.
				<i>kg</i>	
Shelf levels	durable steel construction, supplied with 4 shelf clips	400	1200	70	13-47875
			1600	70	13-47878
		500	1200	70	13-47876
			1600	70	13-47879
		600	1200	70	13-47877
			1600	70	13-47880





## Cube lockers

on high base



- Strong steel construction with high grade powder coating in light grey, RAL 7035. Other colour combinations can be supplied at no extra cost.
- Doors are flush closing with cabinet surface, available as full sheet option or with viewing window (see accessories)
- Cylinder lock complete with 2 keys or cam lock for customer-fitted padlock
- Increased protection for valuable items - optionally available with lock
- Smooth surfaces for easy cleaning
- Extra units with customised subdivision can be added at any time
- 500 mm deep



Cylinder lock complete with 2 keys



Cam lock for customer-fitted padlock

### BITO info

Please specify at time of order:

Colour HOUSING: RAL ...

Colour DOORS: RAL ...

**RAL 5010** **RAL 3000** **RAL 5012** **RAL 7016** **RAL 7035**

The indicated RAL colours for housing and doors can be combined to your choice.

Orders without colour specification will be supplied in light grey, RAL 7035.

### Compartment width 300 mm

- 500 mm deep

Width <i>mm</i>	Height <i>mm</i>	Number of compartments	Number of compartments per level	Number of compartments in height	Lock type	Padlock lock with 7 mm shackle diameter	Cylinder lock with 2 keys	
					Features	Ref. no.	Ref. no.	
300	1850	5	1	5		13-35622	13-35609	
600	855	4	2	2		13-35663	13-35654	
	1187	6	2	3		13-35666	13-35657	
	1518	8	2	4		13-35669	13-35660	
	1850	4	2	2		each compartment is supplied with 1 garment rail and 3 push-along hooks	13-35613	13-35600
		6	2	3			13-35616	13-35603
		8	2	4			13-35619	13-35606
		10	2	5			13-35623	13-35610
900	855	6	3	2		13-35664	13-35655	
	1187	9	3	3		13-35667	13-35658	
	1518	12	3	4		13-35670	13-35661	
	1850	6	3	2		each compartment is supplied with 1 garment rail and 3 push-along hooks	13-35614	13-35601
		9	3	3			13-35617	13-35604
		12	3	4			13-35620	13-35607
		15	3	5			13-35624	13-35611
1200	855	8	4	2		13-35665	13-35656	
	1187	12	4	3		13-35668	13-35659	
	1518	16	4	4		13-35671	13-35662	
	1850	8	4	2		each compartment is supplied with 1 garment rail and 3 push-along hooks	13-35615	13-35602
		12	4	3			13-35618	13-35605
		16	4	4			13-35621	13-35608
		20	4	5			13-35625	13-35612

## Compartment width 400 mm

■ 500 mm deep

Width <i>mm</i>	Height <i>mm</i>	Number of compartments	Number of compart- ments per level	Number of compart- ments in height	Lock type	Cylinder lock with 2 keys	Padlock lock with 7 mm shackle diameter	
					Features	Ref. no.	Ref. no.	
400	1850	5	1	5		13-35635	13-35648	
800	855	4	2	2		13-35672	13-35681	
	1187	6	2	3		13-35675	13-35684	
	1518	8	2	4		13-35678	13-35687	
	1850	4	2	2		each compartment is supplied with 1 garment rail and 3 push-along hooks	13-35626	13-35639
		6	2	3			13-35629	13-35642
		8	2	4			13-35632	13-35645
		10	2	5			13-35636	13-35649
1200	855	6	3	2		13-35673	13-35682	
	1187	9	3	3		13-35676	13-35685	
	1518	12	3	4		13-35679	13-35688	
	1850	6	3	2		each compartment is supplied with 1 garment rail and 3 push-along hooks	13-35627	13-35640
		9	3	3			13-35630	13-35643
		12	3	4			13-35633	13-35646
		15	3	5			13-35637	13-35650
1600	855	8	4	2		13-35674	13-35683	
	1187	12	4	3		13-35677	13-35686	
	1518	16	4	4		13-35680	13-35689	
	1850	8	4	2		each compartment is supplied with 1 garment rail and 3 push-along hooks	13-35628	13-35641
		12	4	3			13-35631	13-35644
		16	4	4			13-35634	13-35647
		20	4	5			13-35638	13-35651

CABINETS & CUPBOARDS

## Accessories



**A** Sloping top



**B** Additional charge for door with mail slot



**C** Additional charge for door with viewing window

Pos.	Description	Dimensions mail slot L x H <i>mm</i>	Total width <i>mm</i>	For a compart- ment width of <i>mm</i>	Ref. no.	
<b>A</b>	Sloping top	epoxy-coated in light grey RAL 7035, can be retro-fitted as required, rear height 200 mm, front height 40 mm	-	600	-	13-35725
			-	800	-	13-35726
			-	900	-	13-35727
			-	1200	-	13-35728
			-	1600	-	13-35729
<b>B</b>	Additional charge for door with mail slot	Doors with mail slot (extra charge)	240 x 10	-	300	13-35652
			250 x 10	-	400	13-35653
<b>C</b>	Additional charge for door with viewing window	Doors with viewing window instead of full sheet front (extra charge), no viewing window for 1850 mm high cabinets with 2, 3 or 4 tiers	-	-	300	13-35690
			-	-	400	13-35691

## Garment lockers



- Doors are flush fitting, reinforced and have air vents, delivery includes towel hook and framed label holder
- Each compartment is supplied with a fitted hat shelf, a garment rail and 3 push-along hooks
- Smooth, easy-to-clean surfaces
- Fully compliant with the regulations of accident prevention and insurance associations and national health and safety at work acts
- 25 colour combinations without supplement

### i BITO info

Please specify at time of order:

Colour HOUSING: RAL ...

Colour DOORS: RAL ...

**RAL 5010** **RAL 3000** **RAL 5012** **RAL 7016** **RAL 7035**

The indicated RAL colours for housing and doors can be combined to your choice.

Orders without colour specification will be supplied in light grey, RAL 7035.

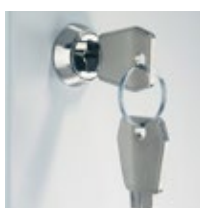

Cylinder lock complete with 2 keys

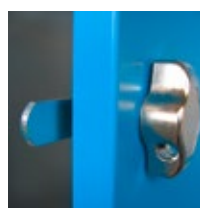

Cam lock for customer-fitted padlock

CABINETS & CUPBOARDS



**TOP SELLER**  
13-20735



Cabinets for fire fighting equipment on page 163

With feet, height 1850 mm

Number of compartments	Compartment width <i>mm</i>	Total width <i>mm</i>	Lock type Depth <i>mm</i>	Cylinder lock with 2 keys	Padlock lock with 7 mm shackle diameter
				Ref. no.	Ref. no.
2	300	600	500	13-20730	13-20735
	400	800	500	13-20733	13-20738
3	300	900	500	13-20731	13-20736
	400	1200	500	13-20734	13-20739
4	300	1200	500	13-20732	13-20737
	400	1600	500	13-20760	13-20761

## On high base, height 1850 mm

Number of compartments	Compartment width <i>mm</i>	Total width <i>mm</i>	Lock type	Cylinder lock with 2 keys	Padlock lock with 7 mm shackle diameter
			Depth <i>mm</i>	Ref. no.	Ref. no.
2	300	600	500	13-20740	13-20745
	400	800	500	13-20743	13-20748
3	300	900	500	13-20741	13-20746
	400	1200	500	13-20744	13-20749
4	300	1200	500	13-20742	13-20747
	400	1600	500	13-20762	13-20763



## With seating unit, total height 2150 mm

- Height adjustable seating unit with 2 white plastic slats 120 x 30 mm, seating height 430 mm
- Beech wood slats upon request
- Locker depth 500 mm, overall depth 800 mm

Number of compartments	Compartment width <i>mm</i>	Total width <i>mm</i>	Lock type	Cylinder lock with 2 keys	Padlock lock with 7 mm shackle diameter
			Depth <i>mm</i>	Ref. no.	Ref. no.
2	300	600	800	13-20750	13-20755
	400	800	800	13-20753	13-20758
3	300	900	800	13-20751	13-20756
	400	1200	800	13-20754	13-20759
4	300	1200	800	13-20752	13-20757



## Accessories



**A** Sloping top

Pos.	Description	Width <i>mm</i>	Ref. no.
<b>A</b>	Sloping top epoxy-coated in light grey RAL 7035, can be retro-fitted as required, rear height 200 mm, front height 40 mm	600	13-35725
		800	13-35726
		900	13-35727
		1200	13-35728
		1600	13-35729



## Z-fronted wardrobes



The space miracle

- Each compartment is supplied with a garment rail and 3 push-along hooks
- Doors are flush closing, reinforced and have air vents

### **i** BITO info

Please specify at time of order:

Colour HOUSING: RAL ...

Colour DOORS: RAL ...

**RAL 5010** **RAL 3000** **RAL 5012** **RAL 7016** **RAL 7035**

The indicated RAL colours for housing and doors can be combined to your choice.

Orders without colour specification will be supplied in light grey, RAL 7035.

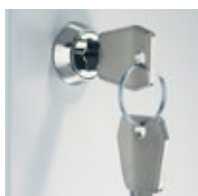

Cylinder lock complete with 2 keys

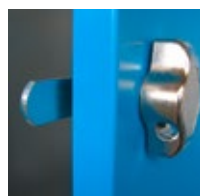

Cam lock for customer-fitted padlock



### On high base

- 500 mm deep

Height	Total width	Compartment width	Lock type		
			Number of compartments	Ref. no.	
mm	400	200 / 400	2	13-35716	13-35713
	800	200 / 400	4	13-35717	13-35714
	1200	200 / 400	6	13-35718	13-35715

### With seating unit

- Beech wood slats upon request
- Seating height 430 mm
- All feet are levelling feet to compensate floor unevenness
- Locker depth 500 mm, overall depth 800 mm



Height	Total width	Compartment width	Lock type		
			Number of compartments	Ref. no.	
mm	400	200 / 400	2	13-35722	13-35719
	800	200 / 400	4	13-35723	13-35720
	1200	200 / 400	6	13-35724	13-35721

## Cloakroom bench seats

- Square tubed framework 30/2 with levelling feet
- Single sided benches with 3 slats, double sided benches with 6 slats
- Slats available from white PVC (size 120 x 30 mm) or from beech wood (size 115 x 20 mm)
- Framework epoxy-coated in light grey, RAL 7035
- Cloakroom benches can be bolted to each other



with beech wood slats



with PVC slats



Features	Width <i>mm</i>	Depth <i>mm</i>	Height <i>mm</i>	Ref. no.
with beechwood slats	1000	370	420	13-35695
	1500	370	420	13-35696
	2000	370	420	13-35697
with PVC slats	1000	370	430	13-35692
	1500	370	430	13-35693
	2000	370	430	13-35694



single sided unit  
with beechwood slats



single sided unit  
with PVC slats



double sided  
with beechwood slats



double sided  
with PVC slats



### With coat hook stand

- Benches with plastic slats: seating height 430 mm, benches with beech wood slats: seating height 420 mm
- Hidden coat hooks, 4 pcs per running metre

Description	Width <i>mm</i>	Height <i>mm</i>	Features	with PVC slats	with beechwood slats
			Depth <i>mm</i>	Ref. no.	Ref. no.
single sided use	1000	1600	400	13-35698	13-35701
	1500	1600	400	13-35699	13-35702
	2000	1600	400	13-35700	13-35703
double sided use	1000	1600	770	13-35704	13-35707
	1500	1600	770	13-35705	13-35708
	2000	1600	770	13-35706	13-35709

### Zubehör

Description	Length <i>mm</i>	Depth <i>mm</i>	Ref. no.
Shoe racks	1000	300	13-35710
	1500	300	13-35711
	2000	300	13-35712





### Drawer cabinets

#### Classic Line



- Sturdy structure made from top quality thin-rolled sheet metal, load capacity up to 1000 kg
- Top quality eco-friendly epoxy coating, housing in anthracite grey, RAL 7016, drawer fronts in light grey, RAL 7035
- Theft-proof central locking mechanism with cylinder lock and 2 keys, optionally available with combination lock
- Full width aluminium handles already assembled to drawers
- Galvanised drawers with smooth sides. Insert kits can be added later to suit your needs; dividers can be fitted in 50 mm intervals. This option is available for drawers with a front height of 75 mm or more.
- Supplied with drawer selection mechanism (anti-tilt) to prevent that more than one drawer at a time is pulled out of housing
- Drawers are self-closing, fully extractable and run on ball-bearing slides. Load capacity 30 kg for drawers with a 50 mm drawer front, 80 kg for drawers with a front height of 75 mm or more.
- Other variations and drawer divider kits upon request.

CABINETS & CUPBOARDS

**TOP SELLER** !

13-45501



A



B



C



D

#### Classic Line, width 600 mm

Pos.	Height <i>mm</i>	Number of drawers	Depth	
			575 mm	Ref. no.
A	620	5	Drawer height 5 x 100 mm	13-45500
B	820	5	1 x 50 mm 3 x 150 mm 1 x 200 mm	13-45501
C	920	8	8 x 100 mm	13-45503
D	1020	7	1 x 50 mm 2 x 100 mm 3 x 150 mm 1 x 200 mm	13-45502



A



B



C



D

## Classic Line, width 700 mm

Pos.	Height mm	Number of drawers	Depth	575 mm
			Drawer height	Ref. no.
A	620	5	5 x 100 mm	13-45504
B	820	5	1 x 50 mm 3 x 150 mm 1 x 200 mm	13-45505
C	920	6	1 x 50 mm 1 x 100 mm 3 x 150 mm 1 x 200 mm	13-45506
D	1020	9	9 x 100 mm	13-45507



A



B



C



D

## Classic Line, width 900 mm

Pos.	Height mm	Number of drawers	Depth	575 mm
			Drawer height	Ref. no.
A	820	7	7 x 100 mm	13-45508
B	920	8	8 x 100 mm	13-45509
C	1020	7	1 x 50 mm 2 x 100 mm 3 x 150 mm 1 x 200 mm	13-45510
D	1220	8	1 x 50 mm 2 x 100 mm 3 x 150 mm 2 x 200 mm	13-45511





### Drawer cabinets

Premium Line



- Sturdy structure made from top quality thin-rolled sheet metal, load capacity up to 1500 kg
- Top quality eco-friendly epoxy coating, housing in light grey RAL 7035, drawer fronts in light blue RAL 5012
- Theft-proof central locking mechanism with cylinder lock and 2 keys, optionally available with combination lock
- Recessed full width aluminium handles sitting flush with cabinet front
- Epoxy-coated drawers, inner sides slotted on a 25 mm pitch for fast and easy divider fitting, many fitting options to suit your requirements
- Supplied with drawer selection mechanism (anti-tilt) to prevent that more than one drawer at a time is pulled out of housing
- Fully extractable drawers on ball bearing drawer runners, load capacity 50 kg for drawers with a front height of 50 mm, 100 kg for drawers with a front height from 75 mm, 180 kg for drawers with a front height of 100 mm or more
- Other configurations and drawer divider kits on [www.shop.bitto.com](http://www.shop.bitto.com)

**TOP SELLER**

13-45512



A



B



C



D

Premium Line, width 705 mm

Pos.	Height mm	Number of drawers	Depth	
			Drawer height	736 mm Ref. no.
A	1019	6	1 x 75 mm 1 x 125 mm 2 x 150 mm 2 x 200 mm	13-45512
B	1019	7	1 x 75 mm 2 x 100 mm 1 x 125 mm 2 x 150 mm 1 x 200 mm	13-45513
C	1019	8	2 x 75 mm 4 x 100 mm 1 x 150 mm 1 x 200 mm	13-45514
D	1019	9	9 x 100 mm	13-45515

## Configuration options for drawer cabinets



### Housing for drawer cabinets, Premium Line, width 705 mm

■ Overall height = useful height + 119 mm

Useable height <i>mm</i>	Height <i>mm</i>	Depth	
		Width <i>mm</i>	736 mm Ref. no.
400	519	705	13-45516
600	719	705	13-45517
700	819	705	13-45518
900	1019	705	13-45519
1200	1319	705	13-45520
1400	1519	705	13-45521

#### **i** BITO info

Customise your drawer cabinet!  
Select cabinet height (= useful height), drawer slides as well as drawer height and load capacity. Drawers with different slide types and load capacities can be combined in one cabinet.

Example:  
Useful height 600 mm  
Ref. no. 13-45517

Useful height 400 to 1400 mm



Example:  
5 drawers  
Useful height 600 mm

Front heights:

Number of drawers (front height)



75 mm  
100 mm  
125 mm  
150 mm  
150 mm



Order example



Example:  
Housing: 1 x 13-45517  
Drawers: 1 x 13-45523, 1 x 13-45524,  
1 x 13-45525, 2 x 13-45526

### Individual drawers, Premium Line, width 600 mm

■ 600 x 600 mm, fully extractable

Load capacity <i>kg</i>	Front height <i>mm</i>	Filling height <i>mm</i>	Useable height <i>mm</i>	Ref. no.
50	50	28 mm	30	13-45522
	100	56 mm	58	13-45523
100	100	81 mm	83	13-45524
	125	81 mm	108	13-45525
	150	131 mm	133	13-45526
	175	131 mm	158	13-45527
	200	181 mm	183	13-45528
	250	181 mm	233	13-45529
	300	181 mm	283	13-45530
	180	100	81 mm	83
125		81 mm	108	13-45532
150		131 mm	133	13-45533
175		131 mm	158	13-45534
200		181 mm	183	13-45535
250		181 mm	233	13-45536
300		181 mm	283	13-45537
300	200	181 mm	183	13-45542
	250	181 mm	233	13-45543
	300	181 mm	283	13-45544



## Drawer cabinets

### Premium Line



- Sturdy structure made from top quality thin-rolled sheet metal, load capacity up to 1500 kg
- Top quality eco-friendly epoxy coating, housing in light grey RAL 7035, drawer fronts in light blue RAL 5012
- Theft-proof central locking mechanism with cylinder lock and 2 keys, optionally available with combination lock
- Recessed full width aluminium handles sitting flush with cabinet front
- Epoxy-coated drawers, inner sides slotted on a 25 mm pitch for fast and easy divider fitting, many fitting options to suit your requirements
- Supplied with drawer selection mechanism (anti-tilt) to prevent that more than one drawer at a time is pulled out of housing
- Fully extractable drawers on ball bearing drawer runners, load capacity 50 kg for drawers with a front height of 50 mm, 100 kg for drawers with a front height from 75 mm, 180 kg for drawers with a front height of 100 mm or more
- Other configurations and drawer divider kits on [www.shop.bitto.com](http://www.shop.bitto.com)

CABINETS & CUPBOARDS



### Premium Line, width 1005 mm

Pos.	Height mm	Number of drawers	Depth	Ref. no.
			Drawer height	
A	1019	6	736 mm 2 x 100 mm 2 x 150 mm 2 x 200 mm	13-45545
B	1019	7	1 x 50 mm 2 x 100 mm 3 x 150 mm 1 x 200 mm	13-45546
C	1019	8	2 x 50 mm 3 x 100 mm 2 x 150 mm 1 x 200 mm	13-45547
D	1319	9	2 x 50 mm 2 x 100 mm 2 x 150 mm 3 x 200 mm	13-45548
E	1519	10	2 x 50 mm 2 x 100 mm 2 x 150 mm 4 x 200 mm	13-45549
F	1519	12	9 x 100 mm 2 x 150 mm 1 x 200 mm	13-45550

## Configuration options for drawer cabinets



### Housing for drawer cabinets, Premium Line, width 1005 mm

■ Overall height = useful height + 119 mm

Useable height <i>mm</i>	Height <i>mm</i>	Depth	
		Width <i>mm</i>	Ref. no.
400	519	1005	13-45551
600	719	1005	13-45552
700	819	1005	13-45553
900	1019	1005	13-45554
1200	1319	1005	13-45555
1400	1519	1005	13-45556

#### **i** BITO info

Customise your drawer cabinet!  
Select cabinet height (= useful height), drawer slides as well as drawer height and load capacity. Drawers with different slide types and load capacities can be combined in one cabinet.

Example:  
Useful height 600 mm  
Ref.no. 13-45552

Useful height 400 to 1400 mm



Example:  
5 drawers  
Useful height 600 mm

Front heights:

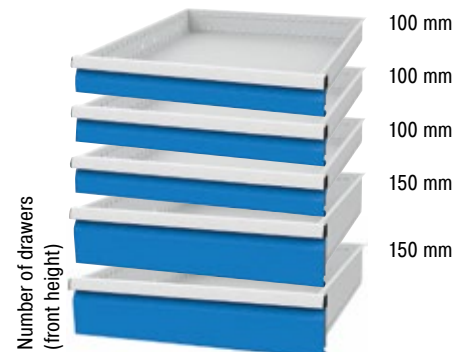

Order example



Example:  
Housing: 1x 13-45552  
Drawers: 3x13-45559, 2x13-45561

### Individual drawers, Premium Line, width 900 mm

■ 900 x 600 mm, fully extractable

Load capacity <i>kg</i>	Front height <i>mm</i>	Filling height <i>mm</i>	Useable height <i>mm</i>	Ref. no.	
50	50	28 mm	30	13-45557	
	100	75	56 mm	58	13-45558
		100	81 mm	83	13-45559
		125	81 mm	108	13-45560
		150	131 mm	133	13-45561
		175	131 mm	158	13-45562
		200	181 mm	183	13-45563
		250	181 mm	233	13-45564
300	181 mm	283	13-45565		
180	100	81 mm	83	13-45566	
	125	81 mm	108	13-45567	
	150	131 mm	133	13-45568	
	175	131 mm	158	13-45569	
	200	181 mm	183	13-45570	
	250	181 mm	233	13-45571	
300	300	181 mm	283	13-45572	
	200	181 mm	183	13-45577	
	250	181 mm	233	13-45578	
	300	181 mm	283	13-45579	





**Sustainable and efficient storage and picking systems**



The logistics sector is the growth market of the future. Fast material flow, time conscious coordination of each step and lean procedures are key indicators to measure the success of any logistics chain. All these requirements can only be met with cost efficient and reliable storage and handling systems.

When it comes to realising such systems, companies that manufacture all components in their own plant, provide project planning and accompany project realisation have a clear advantage. Companies like BITO.

In-house production of shelving and racking as well as of bins and containers guarantees safe project management through higher transparency and efficiency. Time schedules can be precisely observed, coordination between the departments involved is easier as information paths are shorter.



## Contents

<b>Multi-tier installations/Mezzanines .....</b>	<b>388</b>
<b>Carton live storage systems .....</b>	<b>390</b>
<b>Automated small parts storage .....</b>	<b>392</b>
<b>Pallet racking PRO .....</b>	<b>394</b>
<b>Drive-in racking .....</b>	<b>396</b>
<b>Pallet live storage PROflow .....</b>	<b>398</b>
<b>Cantilever racking.....</b>	<b>400</b>
<b>PROmobile pallet racking .....</b>	<b>402</b>

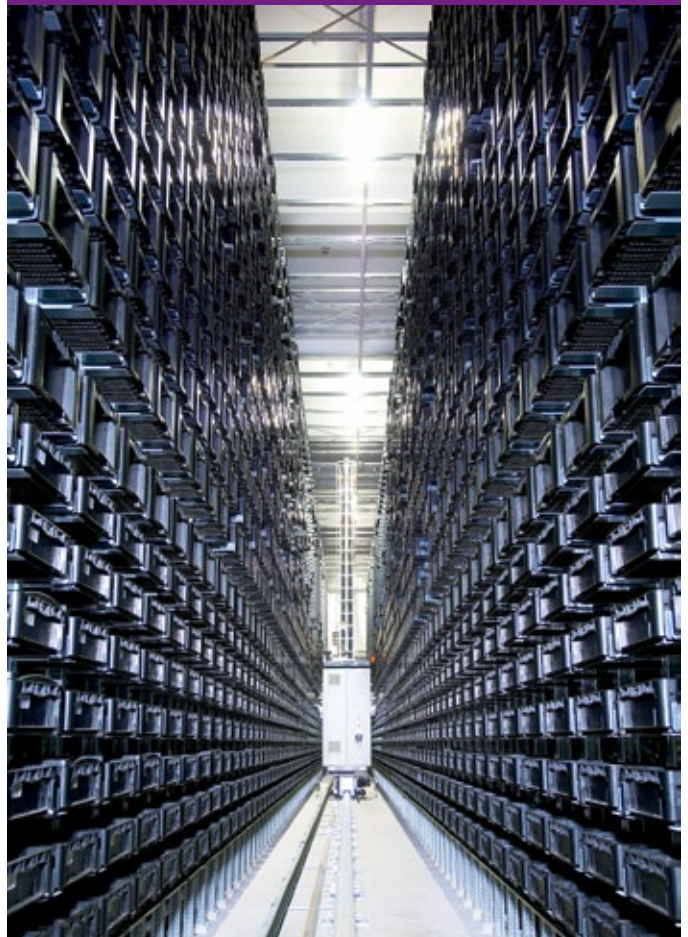





## BITO Multi-tier installations / Mezzanines

Within any warehouse, space utilisation, i.e. floor space taken and height utilised, is key to shelving and racking efficiency.

Shelving – whether used as independent solution or as part of a facility in which different storage techniques are applied – is the perfect system for multi-tier applications.

It solves the problem of limited floor space by adding further tiers to make full use the ceiling height in a building.





## Your benefits

- Good space utilisation as floor surface multiplies by making best use of warehouse height
- Compact storage of light-weight and medium-weight storage units
- Simultaneous order picking on several tiers reduces order processing times
- Limited investment as the system components of the floor level construction also carry the upper level(s) with shelving and service aisles and/or a mezzanine floor

### Multi-tier shelving



### Additional work/storage space on top

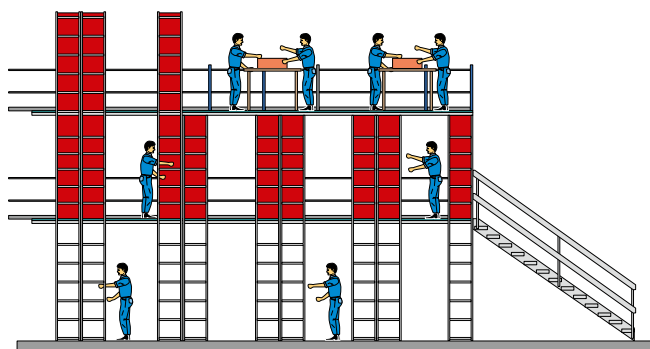

### Mezzanine system BBS



### Additional work/storage space on the floor level



Further information on this product is provided in our catalogue **PROJECT GUIDE** which is available free of charge. To obtain your copy please send us an email to [info@bito.com](mailto:info@bito.com)







## BITO Carton live storage – drastic time savings give a boost to pick quantities

Among order picking installations that work according to the operator-to-goods principle, carton live storage is on the increase. Higher investment costs are more than compensated by improvements in efficiency.

Separate aisles for picking and loading avoid operators disturbing each other. Order pickers can rely on the constant availability of goods at the picking face as all storage units move unassisted into the picking position. Straight working aisles allow immediate identification of product lines which need to be re-stocked, thereby improving picking productivity.

Substantially reduced travel times – between 40% to 70% compared to conventional shelving and racking – and reductions in floor space utilisation of up to 30% make BITO carton live storage a very economic solution for almost any storage environment.



## Your benefits

- High frame load capacities allow to install buffer levels on top for maximum use of headroom
- Automated working processes provide a further increase in efficiency
- Transparent operations and faster response times
- Higher productivity by implementing a fully automated and computer monitored system
- FIFO principle (first in, first out) is strictly observed
- Link-up to warehouse management systems allows permanent inventory control
- Inclined live storage levels make sure that all loads move unassisted to the picking face, even loads with poor travel characteristics

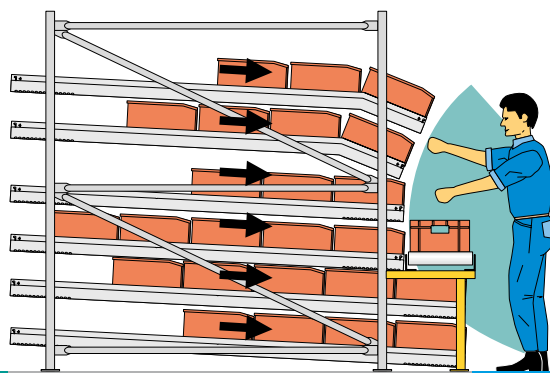

Ergonomically designed picking face

## Kanban shelving



## Automated carton live storage



## Carton live storage with buffer stock on top



STORAGE AND ORDER PICKING SOLUTIONS



Further information on this product is provided in our catalogue **PROJECT GUIDE** which is available free of charge. To obtain your copy please send us an email to [info@bito.com](mailto:info@bito.com)





## Automated small parts storage and retrieval – the ultimate boost for operational efficiency

Order picking installations based on the goods-to-operator principle are increasingly integrated into total logistic systems. Most common on the market are ASRS systems – automated small parts storage and retrieval systems (BITO type „AKL“) with individual locations for bins and trays.

In this market, BITO is one of the few suppliers to provide the racking technology complete with bins, containers and trays.



## Your benefits

- Extremely short access times
- Optimum utilisation of available warehouse height with high bay shelving and racking
- Modern warehouse management systems provide a very good availability of all product lines and permanent inventory control
- Even heavy-weight storage units can be handled conveniently
- Closed system prevents unauthorised access to goods

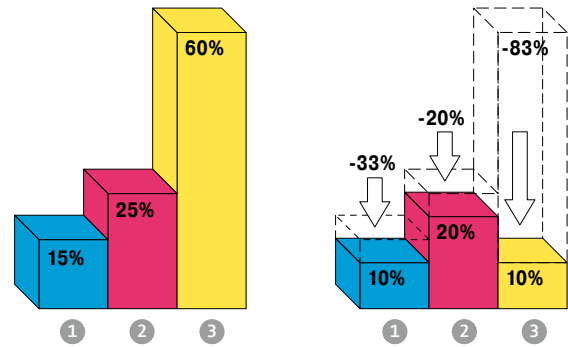

The optimum ergonomic layout of the picking area in front of an automated bin or tray storage installation reduces reading and picking times. There is almost no walking required for order pickers which reduces travel times considerably.  
 (1) Reading (2) Picking (3) Travelling

## Plastic bins and containers



## Plastic trays



## Steel trays with collar



## Steel trays



## Customised solutions



Further information on this product is provided in our catalogue **PROJECT GUIDE** which is available free of charge. To obtain your copy please send us an email to [info@bito.com](mailto:info@bito.com)





## BITO Pallet racking – the ageless „classic“ in product storage and handling

Racking installations with wide aisles are the most common solution. As a rule, loading and unloading is done with front stackers, stacker cranes or order picking trucks.

Pallet racking can also be realised as a narrow aisle configuration. In most cases, loading and picking is done with rail guided or inertially guided vehicles.



## Your benefits

- Accommodates Euro pallets, wire-mesh box pallets and special size pallets
- Various bay widths and constructive details allow long and short side pallet handling
- Double deep storage
- Compatible with other shelving and racking systems
- Allows automated servicing
- Can be realised as multi-tier construction
- Broad range of system specific accessories

## Broad aisle configuration

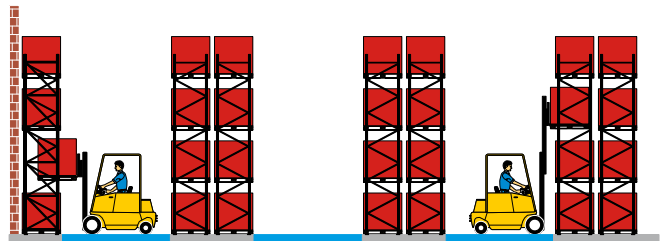

## Narrow aisle configuration

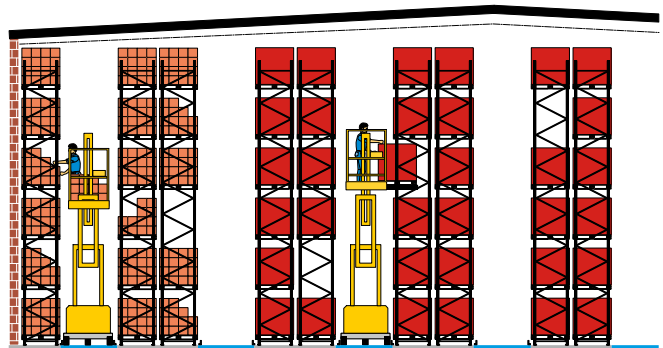
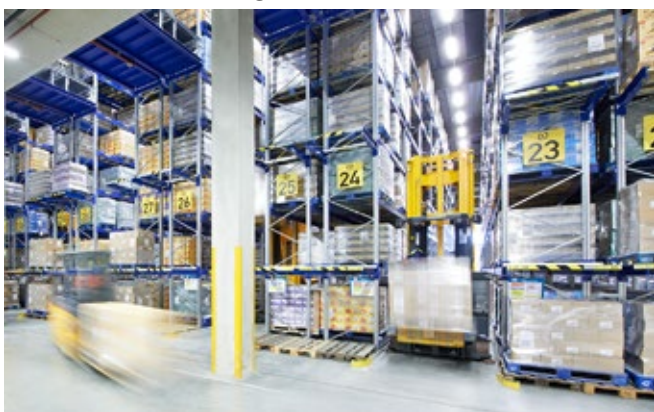

## Automated pallet racking

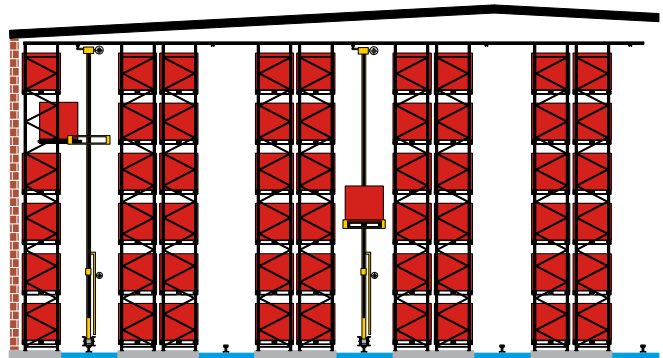

Further information on this product is provided in our catalogue **PROJECT GUIDE** which is available free of charge. To obtain your copy please send us an email to [info@bito.com](mailto:info@bito.com)



STORAGE AND ORDER PICKING SOLUTIONS





## BITO Drive-in racking

– requires fewer service aisles, allowing you to save on expensive storage space

Drive-in racking allows storage of several pallets in depth per storage level, thus providing optimum utilisation of floor surface and warehouse volume.

This storage solution is ideal for low pallet turnover such as seasonal storage.



## Your benefits

- Cost efficient high-density storage
- Optimum utilisation of warehouse surface and height
- Good utilisation of available storage volume
- Safe storage of pressure sensitive goods and pallets with unstable loads
- Hook-in brackets allow fast and easy adjustment of storage levels

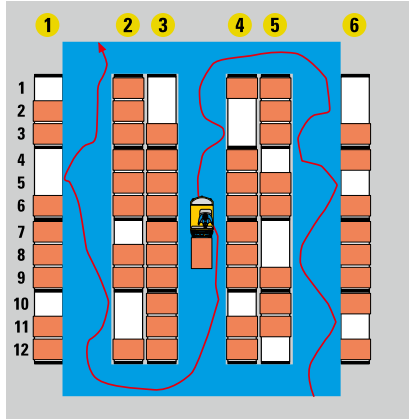

Classic pallet racking

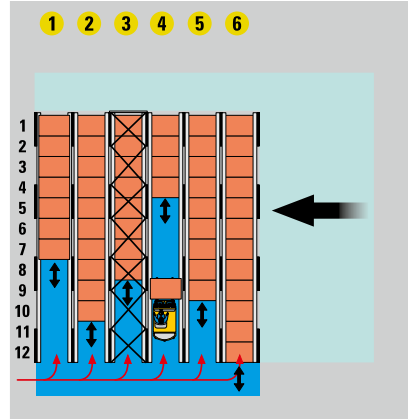

Drive-in racking

## Drive-in racking configuration

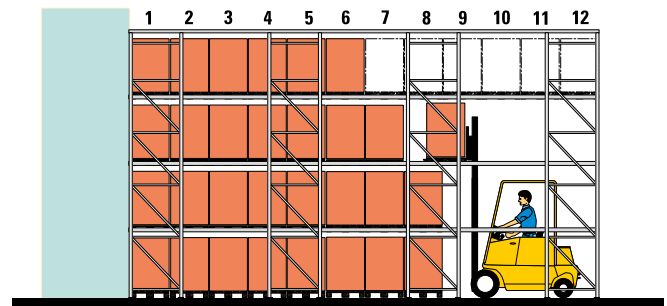

STORAGE AND ORDER PICKING SOLUTIONS

➔ Further information on this product is provided in our catalogue **PROJECT GUIDE** which is available free of charge. To obtain your copy please send us an email to [info@bito.com](mailto:info@bito.com)





## BITO Pallet live storage PROflow – gets your stock moving

Pallet live storage systems play an increasingly important role in storage and handling, as users recognise their potential for improving efficiency.

In the past, pallet live storage was mainly used for buffer stocks in production areas, warehouses and despatch departments. Today, the focus is on using the pallet live storage system for order picking according to the FIFO-principle or as space saving push-back solution working on the LIFO basis.

Lane configuration making best use of space in racking width and height provides high-density storage and allows optimum use of the available headroom.

The increase in efficiency over conventional racking can be as high as 60%.

Moreover, constant availability of stock avoids idle times.



## Your benefits

- Compared to bulk storage, live storage provides direct access to all reference lines on stock
- High degree of flexibility, fast order picking
- Adherence to the FIFO principle (first in, first out)
- Easy control of sell-by dates, call-off quantities and production batches
- No idle times
- Clear layout allows immediate product access thereby reducing process times and improving process predictability
- Separate loading and picking aisles
- Undisturbed working, as lift truck operators cannot get in each other's way. This improves work performance and operational safety in your warehouse.
- Reduced number of racking aisles, shorter in-house travel routes
- Gain in storage space of up to 60% compared to conventional pallet racking. Compact storage on a smaller surface is less energy consuming; a 40% reduction in travel time reduces electricity/fuel consumption of service vehicles.

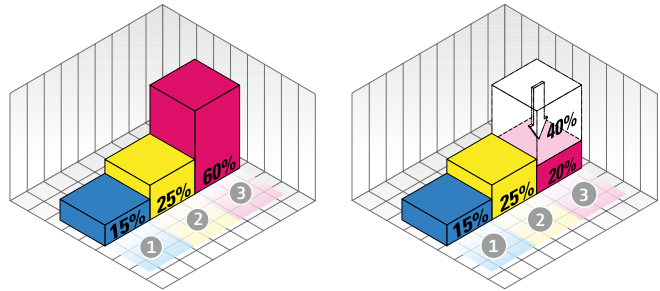

Compared to conventional pallet racking, pallet live storage reduces travel times by two thirds.

(1) Reading (2) Picking (3) Travelling



Further information on this product is provided in our catalogue **PROJECT GUIDE** which is available free of charge. To obtain your copy please send us an email to [info@bito.com](mailto:info@bito.com)



Scan this QR code:  
**Product video PROflow**  
[www.bitto.com/qr-proflow-int](http://www.bitto.com/qr-proflow-int)

## FlowStop load separator



The BITO FlowStop load separator has been designed to reliably separate the first pallet at the picking face from the other pallets in the lane. This allows to retrieve the pallet at the picking face safely without lane pressure and without damaging the FlowStop load separator. The load separator has been fitted out of reach for truck forks. This means substantially lower repair costs as well as safe and convenient pallet loading and unloading.

## Pallet live storage

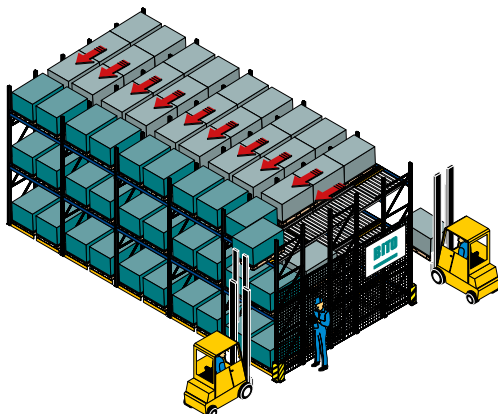

Operates according to the FIFO principle: first in, first out

## Push-back pallet racking

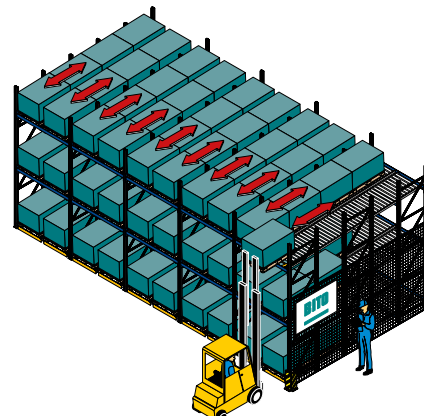

Operates according to the LIFO principle: last in, first out





## BITO Cantilever racking – ideal for long and bulky loads

Cantilever racking is a very versatile storage system which accommodates a wide range of loads: long loads such as bars and pipes, flat materials like wooden and metal sheets and plates as well as bulky items.

The system's complete modularity is a big asset for a „perfect fit“. All components can be manufactured to suit your individual requirements as to load capacity and layout.

Based on your specific data such as warehouse or storage area dimensions, flooring characteristics and product requirements we will work out a customised solution. Our experienced team will be pleased to provide professional support.





## Your benefits

- For rigid long loads: cantilever arms with and without end stop
- For flexible long loads, bars of any length and bulky goods: straight cantilever arms with shelves
- For ergonomically favourable picking at assembly places: inclined cantilever arms with shelves
- For coils and vertically stored goods: tubular arms



Further information on this product is provided in our catalogue **PROJECT GUIDE** which is available free of charge. To obtain your copy please send us an email to [info@bito.com](mailto:info@bito.com)

## Cantilever racking for indoor use



## Cantilever racking for outdoor use



## Mobile cantilever racking



## For heavy duty applications







## Maximum storage density with PRO mobile pallet racking

Floor space optimisation and storage density are key to any consideration of cutting down warehouse costs. When the aim is to make optimum use of existing floor space or to reduce floor space occupation in order to create space for another purpose, mobile pallet racking will be the most efficient solution.

Depending on the system installed, storage capacity increases by up to 80% and floor space occupation reduces by up to 50%. These savings translate into a real money value, as investment costs are reduced considerably for new warehouse constructions.

Modern warehouse management systems combined with thorough planning and knowledgeable support from concept to completion are a sound basis for realising efficient storage solutions.





## Your benefits

- **Save on space in new constructions**
  - Compact storage saves on floor surface and storage volume
  - Floor space is released by eliminating the need for several aisles
  - Savings on energy costs, particularly in cooler and freezer storage environments
  - Substantially reduced investment cost
- **Gain storage capacity in existing premises**
  - Substantial increase in storage capacity on the same surface area
  - No costs for setting up a new building
  - Optimum use of floor space in existing premises

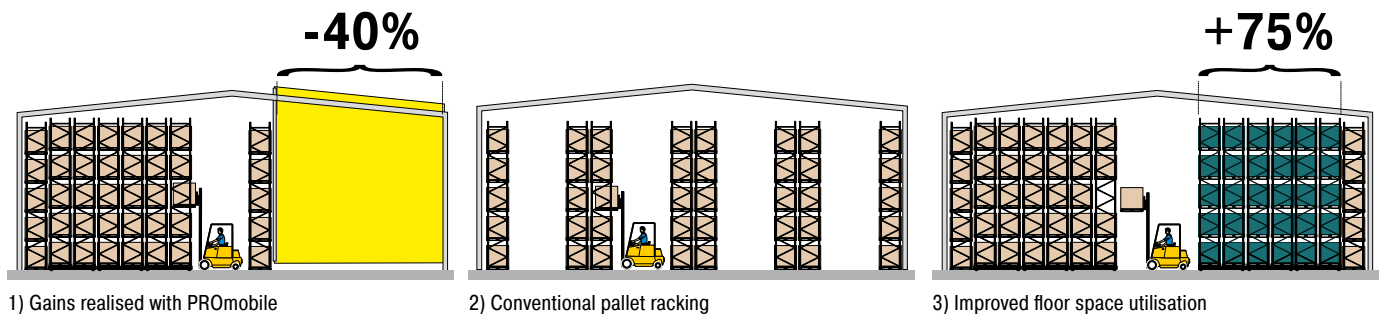

## PROmobile pallet racking



STORAGE AND ORDER PICKING SOLUTIONS

➔ Further information on this product is provided in our catalogue **PROJECT GUIDE** which is available free of charge. To obtain your copy please send us an email to [info@bito.com](mailto:info@bito.com)

## 0-9

- 2-component LEO track paint .....303
- 360° hemispherical mirrors .....283

## A

- Access steps .....329
- Adapters > Flexi-posts.....272
- Additional charge for door with mail slot > Cube lockers .....375
- Additional charge for door with viewing window > Cube lockers...375
- Additional fencing planks .....205
- Additional hose levels
  - > Hose shelving .....162
- Additional levels > Shelving with extra large shelves .....148
- Additional levels
  - > Supply shelving .....150, 151, 152, 153
- Additional shelf levels > Shelving with extra large shelves .....149
- Additional shelves > Shelving .....174
- Add-on feet > BITO TEC.....349
- Add-on feet for sheet material stands > Sheet material stands.....333
- Add-on fork entry shoes
  - > European size stacking containers XL.....63
- Add-on fork entry shoes > Multi-purpose containers MB....115
- Add-on support stands
  - > Heavy duty pallet dollies .....336
- Aluminium folding steps ...248, 249, 255
- Aluminium folding trolleys.....312
- Aluminium platform steps .....256
- Aluminium transport dollies TR64MB > Multi-purpose containers MB 600 x 400 mm .....99
- Anchor bolts .....192, 200, 213, 214
- Anchor bolts > Shelving .....171
- Archive shelving .....142, 143

## B

- Back cladding .....329
- Back cladding > Shelving .....173
- Back cladding for workbenches > Workbenches .....351
- Back stop beam > Pallet racking .....208
- Barcoded security seals > Multi-purpose containers MB.....91, 99, 109, 115, 119
- Beams > Pallet racking .....196, 197, 198, 201, 260
- Belt barrier posts .....273
- Bend segments
  - > Roller conveyors .....339, 340
- Bin racks .....27
- Bin shelves for loose goods > Shelving .....178
- Bin suspension rails > Louvered panels .....23
- Bin trolleys .....27
- Bins & containers .....14, 15, 134
- BITO PharmaBOX .....90
- Board/panel trucks .....305
- Bolt tensioners
  - > Wire-mesh partitions .....243

- Boltless shelving complete with RK bins .....46, 47, 156
- Boltless shelving complete with SK bins .....28, 158, 159
- Boltless shelving complete with XL and RK bins.....160
- Boltless shelving complete with XL bins.....160
- Boltless shelving for industry requirements .....144, 150
- Boltless shelving with wire baskets ...164
- Bottle holder .....329
- Bracket for back cladding > Wide span racking.....192
- Brackets for back stops and back cladding > Pallet racking.....208
- Brake clips
  - > Unit load order picking.....219
- Brake rollers
  - > Unit load order picking.....219, 224
- Bucket/can holders > Drum racking .....260
- Buffer lane for LEO locative drop-off stations .....299
- Buffer lane for LEO locative pick-up stations .....299

## C

- Cabinet workbenches .....352, 353, 355, 356, 357
- Cabinets & Cupboards ....358, 359, 364, 365, 366, 367
- Cabinets for environmentally hazardous goods.....370
- Cabinets for fire fighting equipment ..163
- Cantilever arms > Cantilever racking components type L and S.....233
- Cantilever arms > Cantilever racking type ES.....241
- Cantilever racking .....226, 236
- Cantilever racking columns > Cantilever racking components type L and S.....232
- Cantilever racking columns > Cantilever racking type ES .....240
- Cantilever racking type ES.....238, 239
- Cantilever racking type L...227, 228, 229
- Cantilever racking type S.....230, 231
- Cantilever trolleys.....332
- Carry/safety handle > Storage and handling bins RK....45
- Carry/safety handle > Storage and handling bins RK, C-item bins CTB .....39, 45
- Carton live storage Flex....221, 222, 223
- Case studies .....134
- Cash & Carry trolleys .....313
- Centre rails.....143
- Chain kit for hemispherical mirrors...283
- Chain links .....273
- Chain posts.....272
- Chipboard decking > Pallet racking.....202
- C-item bins CTB.....37
- C-item bins CTB > Kanban bin shelving for small parts, Mobile Kanban bin shelving for small parts .....38
- Cloakroom bench seats.....379
- Clothes rails (set) > Shelving .....180
- Cold pack PCM .....91

- Cold packs .....92
- Cold packs for chilled and frozen products .....89
- Cold packs for chilled products .....89
- Column guards > Pallet racking.....192, 196, 197, 198, 200, 206
- Complete levels > Pallet racking.....224, 225
- Complete levels > Wide span racking.....191
- Computer desktops > BITO TEC.....349
- Computer workstation > BITO TEC....347
- Connector beams > BITO TEC.....349
- Connector beams > Cantilever racking components type L and S.....233
- Connector beams > Cantilever racking type ES .....240
- Connector clips > Multi-purpose containers MB....99
- Connectors for back-to-back shelving > Shelving .....180
- Container Pick Walls with large XL containers.....35
- Container Pick Walls with medium XL containers .....34
- Container Pick Walls with small XL containers .....34
- Containers for automated systems....66
- Containers with fork entry shoes 800 x 600 .....112, 116, 120
- Corner buffering.....271
- Corner protection barriers .....280
- Corner shelving.....166
- Covers for palletised loads > European size stacking containers XL, Small parts containers KLT .....51, 63, 76, 119
- Cross bracing > Cantilever racking components type L and S.....233
- Cross bracing > Cantilever racking type ES .....241
- Cross bracing > Shelving .....170
- Cross dividers > Insert bins .....61, 77
- Cross dividers > Storage and handling bins PK....41
- Cross dividers > Storage and handling bins RK....45
- Cross dividers > Wide span racking.....192
- Cross dividers CQT > C-item bins CTB .....39
- Cross dividers for thermo boxes .....89
- Cube lockers .....374, 375
- Custom-assembled tilt-open container modules .....49
- Cutter units > BITO TEC .....349

## D

- Data tariff europe-wide SmartHub/SmartLock .....91
- Data tariff worldwide SmartHub/SmartLock .....91
- Display pallets K9.....132
- Display storage systems.....48
- Display systems .....286
- Distribution trays DT 640 .....78
- Distribution trays DT 670 .....79
- Divider bars > Racks for vertical storage.....235

- Divider bars > Sheet material stands and trolleys ..... 333  
 Divider bars for long goods  
   > Shelving ..... 178  
 Document clips > European size stacking containers ..... 65  
 Document pockets ..... 331  
 Document pockets  
   > Multi-purpose containers MB ..... 51, 76, 99, 105, 115, 125  
 Document pockets > Small parts containers KLT ..... 99, 115  
 Document pockets from rigid PVC ..... 288  
 Door modules, 1 wing  
   > Wire-mesh partitions ..... 243  
 Door modules, 2 wings  
   > Wire-mesh partitions ..... 243  
 Drawer blocks > Workbenches ..... 351  
 Drawer blocks with 3 drawers  
   > Shelving ..... 182  
 Drawer blocks with 7 drawers  
   > Shelving ..... 182  
 Drawer cabinets ..... 380, 381, 382, 384  
 Drop-on lid  
   > Heavy duty containers SL ..... 31, 63, 119, 125  
 Drop-on lid > Multi-purpose containers MB ..... 99, 115  
 Drop-on lid > Pallet boxes ..... 128  
 Drop-on lid  
   > Stack and nest containers DSL ..... 110  
 Drop-on lid >  
   Stack and nest containers DST ..... 111  
 Drop-on lid > Stack and nest containers U-Turn ..... 109  
 Drop-on lids > European size stacking containers BN ..... 33, 65  
 Drop-on lids > European size stacking containers XL ..... 31, 63  
 Drop-on lids  
   > Folding boxes EQ ..... 105  
 Drop-on lids  
   > Folding distribution boxes MFB ..... 107  
 Drop-on lids  
   > Small parts containers KLT ..... 76  
 Drop-on lids  
   > Storage bins SK ..... 23  
 Drop-on steel panels  
   > Pallet racking ..... 202  
 Drum pallets ..... 263  
 Drum racking ..... 260, 261  
 Drum supports > Drum racking ..... 260  
 Dust covers > European size stacking containers XL ..... 61, 77  
 Dust covers  
   > Small parts containers KLT ..... 77  
 Dust covers  
   > Storage and handling bins RK ..... 45  
 Dust covers > Storage bins PK ..... 29  
 Dust covers > Storage bins SK ..... 23  
 Dust covers CSD  
   > C-item bins CTB ..... 39  
**E**  
 Easy peel label holders  
   > C-item bins CTB ..... 39  
 Easy peel label holders > Multi-purpose containers MB ..... 99, 101, 115  
 Edge buffering  
   > Edge and corner buffering ..... 271  
 End stop plates  
   > Roller conveyors ..... 342, 343  
 End stops/dividers for cantilever arms  
   > Cantilever racking components type L and S ..... 233  
 Environmental protection ..... 258, 259  
 ESD table trolleys ..... 326  
 European size stacking containers ..... 52, 70, 116  
 European size s tacking containers BN ..... 32, 64  
 European size stacking containers XL ..... 30, 54, 55, 57, 117, 118, 193, 222, 223  
 European size stacking containers XL with double base ..... 59  
 European size stacking containers XL with ribbed base RX ..... 58  
 European size storage bins and containers ..... 30, 34  
 European size trays ..... 79  
**F**  
 Fixing bracket for mirrors ..... 283  
 Fixing elements > Spill prevention systems ..... 262  
 Fixing kit > Steps & shelving access ladders ..... 247  
 Fixing material ..... 26, 172  
 Fixing material > Shelving ..... 26, 172  
 Flexible bollards ..... 276  
 Flexible column and pole protectors ..... 276  
 Flexible end-of-rack barriers ..... 277  
 Flexible pedestrian guard railing ..... 274  
 Flexible safety railing ..... 274  
 Flexible traffic railing ..... 275  
 Flexible traffic railing "Plus" ..... 275  
 Flexible upright protectors  
   > Pallet racking ..... 207  
 Flexi-posts ..... 272  
 Floor anchor set ..... 272  
 Floor level shelves > Cantilever racking components type L and S ..... 233  
 Floor-mounted roller conveyor segments ..... 213  
 Folding boxes EQ ..... 104, 105  
 Folding bulk containers ..... 131  
 Folding containers ..... 102  
 Folding distribution boxes MFB ..... 106  
 Foot plinths > Shelving ..... 180  
 Four sided platform trucks - Grey Edition ..... 325  
 Frame extension  
   > Pallet racking ..... 209  
 Framed sign holders ..... 292  
 Frames for boltless shelving  
   > Shelving ..... 169, 170  
 Frames for wide span racking  
   > Wide span racking ..... 190  
 Full sheet dividers  
   > BITO TEC ..... 349  
 Full sheet dividers  
   > Shelf, 40 mm high ..... 177  
**G**  
 Garment lockers ..... 376, 377  
 Garment lockers/File lockers ..... 369  
 General purpose trolley ..... 310  
 Grip closures > European size stacking containers BN ..... 65  
 Grip closures > European size stacking containers XL ..... 63  
 Guide roller ..... 329  
**H**  
 Hand pallet truck with scissor lift ..... 307  
 Hand pallet trucks ..... 193, 306, 307  
 Hand pallet trucks  
   > Heavy duty containers SL ..... 125  
 Handle ..... 127  
 Handles > European size stacking containers XL, European size stacking containers BN ..... 31, 33  
 Handles > Storage bins PK ..... 29  
 Handles > Storage bins SK ..... 23  
 Handrails for double sided access > Warehouse steps ..... 253  
 Handrails for single sided access  
   > Warehouse steps ..... 253  
 Heavy duty containers ..... 120  
 Heavy duty containers SL ..... 122, 123, 124  
 Heavy duty floor anchors  
   > Impact protection bollards ..... 280  
 Heavy duty hoop barriers ..... 280  
 Heavy duty pallets K2 with feet ..... 132  
 Heavy Duty Pick Walls with SL containers ..... 35  
 Heavy duty roller tracks ..... 214  
 Heavy duty shelving type S - shelf load 300 kg ..... 147  
 Hinge clips for lids > European size stacking containers BN ..... 33, 65  
 Hinged doors > Shelving ..... 181, 351  
 Horizontal spacer plates  
   > Heavy duty containers SL ..... 125  
 Hose shelving ..... 162  
 Housing for drawer cabinets ..... 383, 385  
 Hydraulic stackers ..... 308  
**I**  
 Identification & safety ..... 266, 267, 272  
 Impact protection bollards ..... 280  
 Inclined shelves  
   > Shelf trolleys ..... 323  
 Inclined shelves  
   > Shelving with inclined shelves ..... 154  
 Individual containers for tilt-open container modules  
   > Display storage systems ..... 48  
 Individual drawers  
   > BITO TEC, Workbenches ..... 349, 351  
 Individual drawers > Drawer cabinets "Premium Line" ..... 383, 385  
 Individual drawers > Shelving ..... 182  
 Individual modules  
   > Unit load order picking ..... 224, 225  
 In-house transport ..... 294, 295, 314, 343  
 In-line posts for fencing rows  
   > Pallet racking ..... 205  
 Insert bins > European size stacking containers XL ..... 62  
 Insert bins > European size stacking containers XL, Small parts containers KLT ..... 61  
 Insert bins  
   > Small parts containers KLT ..... 77  
 Insert bins > XLmotion containers for automated systems ..... 69  
 Insertable windows > European size stacking containers BN ..... 33  
 Insertable windows > European size stacking containers XL ..... 31, 119  
 Insertable windows  
   > Storage bins PK ..... 29  
 Insertable windows  
   > Storage bins SK ..... 23  
**J**  
 Janitorial lockers ..... 368  
**K**  
 Kanban bin shelving for small parts ..... 40, 155  
 Kick steps ..... 257  
**L**  
 Label covers > European size stacking containers BN ..... 33, 65  
 Label covers > Small parts containers KLT, European size stacking containers XL ..... 31, 63, 76, 119  
 Label covers  
   > Storage and handling bins RK ..... 45  
 Label covers  
   > Storage bins SK ..... 23  
 Label frames  
   > Folding distribution boxes MFB ..... 107  
 Label holders  
   > Heavy duty containers SL ..... 125  
 Label sheets > Cross dividers ..... 45  
 Label sheets  
   > European size stacking containers XL, Small parts containers KLT ..... 31, 63, 76, 119, 291  
 Label sheets > Self-adhesive ticket holders ..... 291  
 Label sheets > Storage and handling bins RK ..... 45, 177  
 Label sheets  
   > Storage and handling bins RK, Self-adhesive ticket holders ..... 45, 291  
 Label sheets  
   > Storage bins SK ..... 23  
 Label sheets > Storage bins SK, Cross dividers ..... 23, 45, 291  
 Labels ..... 292  
 Labels > European size stacking containers XL, Small parts containers KLT ..... 31, 76  
 Ladder mounting rail, steel > Steps & shelving access ladders ..... 247  
 Lane marking tape "flex" ..... 303  
 Lane marking tape "robust" ..... 303  
 Lane marking tape "ultra" ..... 303  
 Large volume containers ..... 128, 131  
 Large volume nesting and folding containers ..... 131  
 LEO Automatic charging station ..... 301  
 LEO Battery charger ..... 301  
 LEO Charging bar ..... 301  
 LEO custom starter package ..... 298  
 LEO custom transporter ..... 298  
 LEO Handheld scanner ..... 302  
 LEO lithium battery 24 V ..... 301



- LEO locative Blue Spot .....303  
 LEO locative connector set for twin stations.....303  
 LEO locative Drop-off station - set.....299  
 LEO locative Pick-up station - set.....299  
 LEO locative powered roller platform.....299  
 LEO locative station transmitter, push-fit mounting.....303  
 LEO locative transporter.....299  
 LEO locative Twin station - set.....299  
 LEO Smart Box lite.....302  
 LEO Smart Box pro.....302  
 LEO starter package.....299  
 LEO Tablet.....302  
 LEO tablet stand.....302  
 LEO Upgrade Smart Box pro.....302  
 Level decking options to fit BITO-TwinTop® beams  
 > Pallet racking..... 203, 260  
 Lift-up gates  
 > Roller conveyors .....339, 341  
 Light duty pallets K8 with feet ..... 132  
 Light duty shelving type EL - shelf load 100 kg..... 144  
 Light duty shelving type L - shelf load 100 kg..... 145, 166  
 Light duty steel barriers .....279  
 Line marking applicators .....268  
 Line marking paint.....268  
 Load retention plates  
 > Cantilever trolleys .....332  
 Locking clips > Multi-purpose containers MB .....99, 115  
 Locking options > Shelving ..... 183  
 Locking systems BS ..... 76  
 Longitudinal dividers > Insert bins.....61  
 Longitudinal dividers  
 > Storage and handling bins PK.....41  
 Longitudinal dividers  
 > Storage and handling bins RK.... 45  
 Longitudinal dividers  
 > Storage bins SK..... 23  
 Louvered panel kits complete with bins ..... 24  
 Louvered panels > Shelving.....26, 172  
 Louvered panels  
 > Storage bins SK..... 25, 349  
 Louvered panel uprights  
 > Louvered panels ..... 23
- M**  
 Magnetic document holders.....285  
 Magnetic document holders "Security" .....286  
 Magnetic document pockets.....289  
 Magnetic label holders.....293  
 Magnetic label pouches .....293  
 MAGNUM Optimum Box - Foldable pallet boxes..... 130  
 MAGNUM Optimum Box 975 S - MAGNUM Optimum Box..... 130  
 Manual stackers.....308  
 Marking board .....329  
 Marking tape dispensers .....269  
 Marking tapes.....269  
 Medium duty shelving type M - shelf load 200 kg ..... 146  
 Memo board .....329  
 Mesh sided platform trucks ..... 315  
 Mobile access platforms .....252  
 Mobile aluminium access ladders .....251  
 Mobile aluminium access platforms ..254  
 Mobile aluminium platform ladders ..250  
 Mobile shelving trolleys..... 157, 159, 161  
 Mobile workbenches.....354  
 Modular stacking containers EMB. 50, 51  
 Modular workbenches..... 353, 354  
 Multi-purpose containers .....80, 112  
 Multi-purpose containers MB Food & Delivery ..... 82, 83, 84, 89  
 Multi-purpose containers MB..... 82, 83, 84, 85, .....94, 95, 264  
 Multi-purpose containers MB - Mail custom solution..... 95  
 Multi-purpose containers MB Eco.....97  
 Multi-purpose containers MB with double base..... 87, 114, 193  
 Multi-purpose containers MB with ribbed base .....86, 113  
 "Multi-purpose containers MB "Mobile Office" ..... 99  
 Multi-purpose hanging rails  
 > BITO TEC .....349  
 Multi-trip transport solution .....126  
 Multi-trip transport solution for bins and containers .... 51, 65, 76, 99, ..... 105, 109, 119, 125
- N**  
 Nesting and folding containers.....80, 102, 108, 110  
 Non-slip grip matting  
 > Heavy duty containers SL..... 125
- O**  
 Office desks > BITO TEC .....346  
 Order picking of palletised loads .....210  
 Order picking trolleys..... 328, 330
- P**  
 Pallet boxes.....128  
 Pallet collars > European size stacking containers BN ..... 65  
 Pallet container CB1 .....129  
 Pallet container CB3 .....129  
 Pallet dollies.....335  
 Pallet dollies - Grey Edition.....325  
 Pallet dolly .....127  
 Pallet foot sleeves, blue .....289  
 Pallet foot sleeves, transparent .....289  
 Pallet racking.....194  
 Pallet racking - complete sets..... 196, 197, 198  
 Pallet racking - Extension bay > Pallet racking..... 196, 197, 198  
 Pallet racking - Frames > Pallet racking.....199, 200  
 Pallet support bars > Pallet racking.....201  
 Pallet top cap .....127  
 Pallets .....132  
 Pallets K1 with runners.....132  
 Pallets K6 with runners.....132  
 Panelled platform trucks.....315  
 Pick walls with BN containers 600 x 400 mm ..... 34  
 Picking of unit loads .....215, 220  
 Pipework buffering ..... 271  
 Plastic chains .....273  
 Plastic deck trolleys.....318  
 Plastic pallet Euro L1 ..... 133  
 Plastic pallets ..... 132  
 Plastic pallets D1 ..... 133  
 Plastic pallets L3.....133  
 Platform trolleys .....314  
 Platform trolleys - Grey Edition.....324  
 Platform trucks with folding handle ..... 312  
 Platform trucks with four sides ..... 316, 317  
 Platform trucks with handle bar .....310, 314, 326  
 Platform trucks with handle bar - Grey Edition .....324  
 Platform trucks with one short side ..... 316, 317, 327  
 Platform trucks with three sides ..... 316, 317  
 Platform trucks with two short sides ..... 316, 317  
 Post and chain kits .....272  
 Post mounted signs.....273  
 Posts > Wire-mesh partitions.....243  
 Product feeder panels CDS > C-item bins CTB ..... 39  
 Protective caps  
 > Unit load order picking.....219  
 Pt100 4-wire dry ice sensor .....91  
 Pt100 4-wire liquid nitrogen sensor (LN2).....91  
 Pull-out units > Pallet racking .....204  
 Push-back protection  
 > Unit load order picking.....219
- R**  
 Rack end protector set.....205  
 Racks for vertical storage ..... 234, 235  
 Rails for A4 hanging files > Multi-purpose containers MB..... 99  
 Ramp edges .....262  
 Rear upstands > Workbenches ..... 351  
 Replacement lid ..... 92  
 Roll containers with wire mesh sides .331  
 Roll forward tipping skips .....337  
 Roller conveyor segments ..... 212, 213, ..... 338, 340  
 Roller conveyor segments suited for hand pallet truck retrieval ..... 212  
 Roller guard .....213  
 Roller track braces  
 > Unit load order picking.....219  
 Roller track connectors  
 > Unit load order picking.....219  
 Roller tracks ..... 215, 218, 219
- S**  
 Sack trucks ..... 304, 305  
 Safety clips  
 > Folding distribution boxes MFB . 107  
 Scanner holder .....329  
 Scissor lift table.....308  
 Security mirrors.....283  
 Security seals > European size stacking containers XL, Multi-purpose containers MB, Heavy duty containers SL 99, 115, 119  
 Security seals > European size stacking containers XL, Small parts containers KLT .....63, 76  
 Security seals  
 > Folding distribution boxes MFB . 107  
 Security seals > Multi-purpose containers MB .....63, 99, .....109, 115, 119  
 Security seals with laser marking  
 > Folding boxes EQ ..... 105  
 Self-adhesive document holders .....285  
 Self-adhesive document holders "Security" .....285  
 Self-adhesive hazard warning tape ..269  
 Self-adhesive ticket holders.....293  
 Self-locking push handle  
 > Heavy duty pallet dollies .....336  
 Self-tipping skips .....337  
 Service hatches  
 > Wire-mesh partitions .....243  
 Sheet material stands .....333  
 Sheet material trolleys .....333  
 Sheet/plate racks .....242  
 Sheet/plate racks for oddments .....242  
 Shelf clips > Shelving ..... 173  
 Shelf dividers.....177  
 Shelf dividers  
 > Shelf, 25 mm high..... 142, 177  
 Shelf ledges  
 > Shelf, 25 mm high.....47, 142, 156, ..... 159, 174, 180  
 Shelf ledges  
 > Shelf, 40 mm high..... 174, 180  
 Shelf levels > BITO TEC .....349  
 Shelf levels > Cabinets with hinged double door .....360, 361, ..... 362, 363  
 Shelf levels > Cabinets with sliding doors ..... 371, 372, 373  
 Shelf levels > Roll containers..... 331  
 Shelf levels with wire infill .....329  
 Shelf trolleys ..... 321, 322, 323, 327  
 Shelf trolleys - ESD version .....326  
 Shelf trolleys - Grey Edition .....325  
 Shelf, 25 mm high  
 > Shelving .....40, 142, 174  
 Shelf, 40 mm high  
 > Shelving ..... 143, 144, 145, ..... 146, 147, 164, ..... 167, 174, 265, 351  
 Shelves > Cantilever trolleys and mobile tool racks.....332  
 Shelves > Shelving.....185  
 Shelving.....140, 142, 144, ..... 150, 168, 184  
 Shelving & Racking..... 136, 137  
 Shelving access ladders from aluminium ..... 246, 247  
 Shelving for industry requirements - accessories.....168  
 Shelving with extra large chipboard shelves ..... 148  
 Shelving with extra large steel shelves ..... 149  
 Shelving with extra large steel shelves - shelf load 350 kg ..149  
 Shelving with inclined shelves..... 154  
 Shelving with wire shelves ..... 165  
 Shims > Pallet racking .....200  
 Shims > Shelving ..... 171  
 Shims > Wide span racking .....192  
 Shock absorbing bumpers.....270  
 Shoe racks  
 > Cloakroom bench seats ..... 379  
 Side capping for track profiles  
 > Roller conveyors .....342  
 Side cladding > Shelving ..... 171  
 Side cladding for workbenches  
 > Workbenches .....351  
 Side protection > Shelving ..... 142, 143

- Side railing > Roller conveyors ..... 342  
 Sides with bag holder notches 63, 76, 99  
 Skatewheel expandaveyors ..... 343  
 Sliding doors  
 > Wire-mesh partitions ..... 243  
 Sloping top > Cube lockers and garment lockers ..... 375, 377  
 Slot-in divider strips > European size stacking containers BN, European size stacking containers XL, Small parts containers KLT ..... 51, 60, ..... 65, 76, 119  
 Slot-in divider strips  
 > Heavy duty containers SL ..... 125  
 Small parts containers ..... 70  
 Small parts containers KLT ..... 72, 73  
 Small parts containers KLT with double base ..... 75  
 Small parts containers KLT with ribbed base ..... 74  
 Small parts storage ..... 36, 40, 48  
 Small parts storage bins and containers ..... 22  
 SMARTBOX Large volume containers ..... 130  
 SmartHub ..... 91  
 SmartHub Alkaline ..... 91  
 SmartLock ..... 91  
 Spacers ..... 276  
 Spacers for back-to-back pallet racking rows > Pallet racking ..... 209  
 Spigots for louvred panels  
 > Louvred panels ..... 25, 349  
 Spill containment shelving ..... 265  
 Spill deck modules ..... 262  
 Spill trays > Drum racking ..... 261  
 Sprung towbar and coupling pin  
 > Heavy duty pallet dollies ..... 336  
 Stack and nest containers ..... 108, 110  
 Stack and nest containers DSL ..... 110  
 Stack and nest containers DST ..... 111  
 Stack and nest containers U-Turn ..... 108  
 Stainless steel shelving ..... 184  
 Stand alone tilt-open container cabinets  
 > Display storage systems ..... 49  
 Starter marker package ..... 302  
 Steel shelves > Cantilever racking components type L and S ..... 233  
 Step stools ..... 257  
 Stiffening beams > Shelving ..... 176  
 Stock identification signs ..... 290  
 Stock labels ..... 290  
 Storage and handling bins ..... 40  
 Storage and handling bins PK ..... 41  
 Storage and handling bins RK ..... 43  
 Storage bins PK ..... 29  
 Storage bins SK ..... 22  
 Storage bins with pick opening ..... 22, 30, 34  
 Supply chain logistics with C-item bins ..... 36  
 Supply shelving ..... 150, 151, 152, 153  
 Support brackets, aluminium, mounted along rail length > Steps & shelving access ladders ..... 247  
 Support brackets, aluminium, mounted at rail ends > Steps & shelving access ladders ..... 247  
 Support rail for tubular arms  
 > Cantilever racking components type L and S ..... 227  
 Support rails for divider bars  
 > Shelving ..... 178  
 Support trays > Pallet racking ..... 201  
 Surveillance mirrors ..... 283  
 Suspension file kits > Shelving ..... 180  
 Swan neck handle trolleys ..... 311  
 Swivel castor kit complete with 4 castors ..... 309  
**T**  
 Table trolleys ..... 314, 327  
 Table trolleys with multiplex shelves ..... 319, 320  
 Table trolleys with multiplex shelves - Grey Edition ..... 324  
 Table trolleys with steel shelves ..... 318  
 TempBeacon data logger ..... 91  
 Thermo boxes 32 ..... 89  
 Thermo boxes 64 ..... 89  
 Thermo inlays > Multi-purpose containers MB ..... 93  
 Thermo insert boxes ..... 92  
 Thermo insulation sets  
 > Multi-purpose containers MB ..... 92  
 Threaded eye bolts ..... 272  
 Throughbolt anchors  
 > Impact protection bollards ..... 280  
 Throughbolt anchors 12/120 ..... 279, 280  
 Tilt-open container modules ..... 48  
 Tool kit for adjusting flexible buffer profiles  
 > Flexible upright protectors ..... 207  
 TOTALSTOP central locking system ..... 309  
 Tow bar and coupling pin ..... 329  
 Tow bar and coupling pin  
 > Heavy duty pallet dollies ..... 336  
 Towing coupler ..... 127  
 Track connector units  
 > Skatewheel expandaveyors ..... 343  
 Track end guard  
 > Unit load order picking ..... 214  
 Traffic and pedestrian control ..... 272  
 Transport dollies ..... 310  
 Transport dollies - ESD version  
 > Stacking containers 600 x 400 mm / 400 x 300 mm ..... 105, 107, 109  
 Transport dollies  
 > Containers 800 x 600 mm ... 31, 63, ..... 107, 125, 334  
 Transport dollies  
 > Multi-purpose containers MB 600 x 400 mm ..... 99, 334  
 Transport dollies  
 > Multi-purpose containers MB 800 x 400 mm ..... 99, 334  
 Transport dollies  
 > Multi-purpose containers MB 800 x 600 mm ..... 99, 334  
 Transport dollies  
 > Stacking containers 600 x 400 mm / 400 x 300 mm ..... 31, 51, 63, ..... 65, 76, 105, ..... 107, 109, 334  
 Tray shelves  
 > Spill containment shelving ..... 179, 265  
 Trays ..... 78  
 Trays XLT ..... 79  
 Trays XLT-P ..... 79  
 Trough inserts > Shelving ..... 183  
 Tubular cantilever arms  
 > Cantilever racking components type L and S ..... 227  
 Tubular steel push handle  
 > Heavy duty pallet dollies ..... 335  
 Twin support stands  
 > Roller conveyors ..... 341  
 Tyre beams > Shelving ..... 167, 176  
 Tyre shelving ..... 167  
 Tyre trucks ..... 304  
**U**  
 Universal beams > Shelving ..... 176  
 Universal floor anchors S12 + bolt 8/100  
 > Corner protection barriers, Wheel stop barriers, Heavy duty hoop barriers, Light duty steel barriers ..... 279, 280  
 Universal lane dividers  
 > Unit load order picking ..... 224  
 Upright caps > Shelving ..... 180  
 Upright protectors > Pallet racking ..... 206  
 USB Power adapter ..... 91  
 USB Type C charging cable ..... 91  
 Utility cupboards ..... 360, 361, 362, ..... 363, 371, 372, 373  
**V**  
 Vertical wire divider  
 > Racks for vertical storage ..... 235  
**W**  
 Wall fixing brackets  
 > Shelving ..... 171, 185  
 Wall mounted tilt-open container cabinets  
 > Display storage systems ..... 49  
 Wall panels ..... 243  
 Wall receiver clip ..... 273  
 Wheel stop barriers ..... 279  
 Wheel stop barriers for corner areas ..... 279  
 Wide span racking ..... 186, 188, 193  
 Wide span racking  
 > Wide span racking ..... 188, 189  
 Wide span racking, complete units ..... 188, 189  
 Wide span shelving – coordinating products ..... 193  
 Wire baskets  
 > Shelving, Boltless shelving with wire baskets ..... 164, 179  
 Wire divider with label holder  
 > Racks for vertical storage ..... 235  
 Wire dividers ..... 329  
 Wire dividers > Boltless shelving with wire baskets ..... 164, 179  
 Wire shelves  
 > Shelving ..... 165, 179, 265  
 Wire shelves GRID  
 > Shelving ..... 175  
 Wire-mesh back cladding  
 > Pallet racking ..... 192, 208  
 Wire-mesh side cladding for frames  
 > Wide span racking ..... 190  
 Workbenches ..... 350  
 Workstation frames > BITO TEC ..... 346  
 Workstation systems ..... 344, 345  
 Workstations > BITO TEC ..... 347  
 Worktops > BITO TEC ..... 349  
**X**  
 XLmotion containers for automated systems ..... 68  
**Z**  
 Z-fronted wardrobes ..... 378

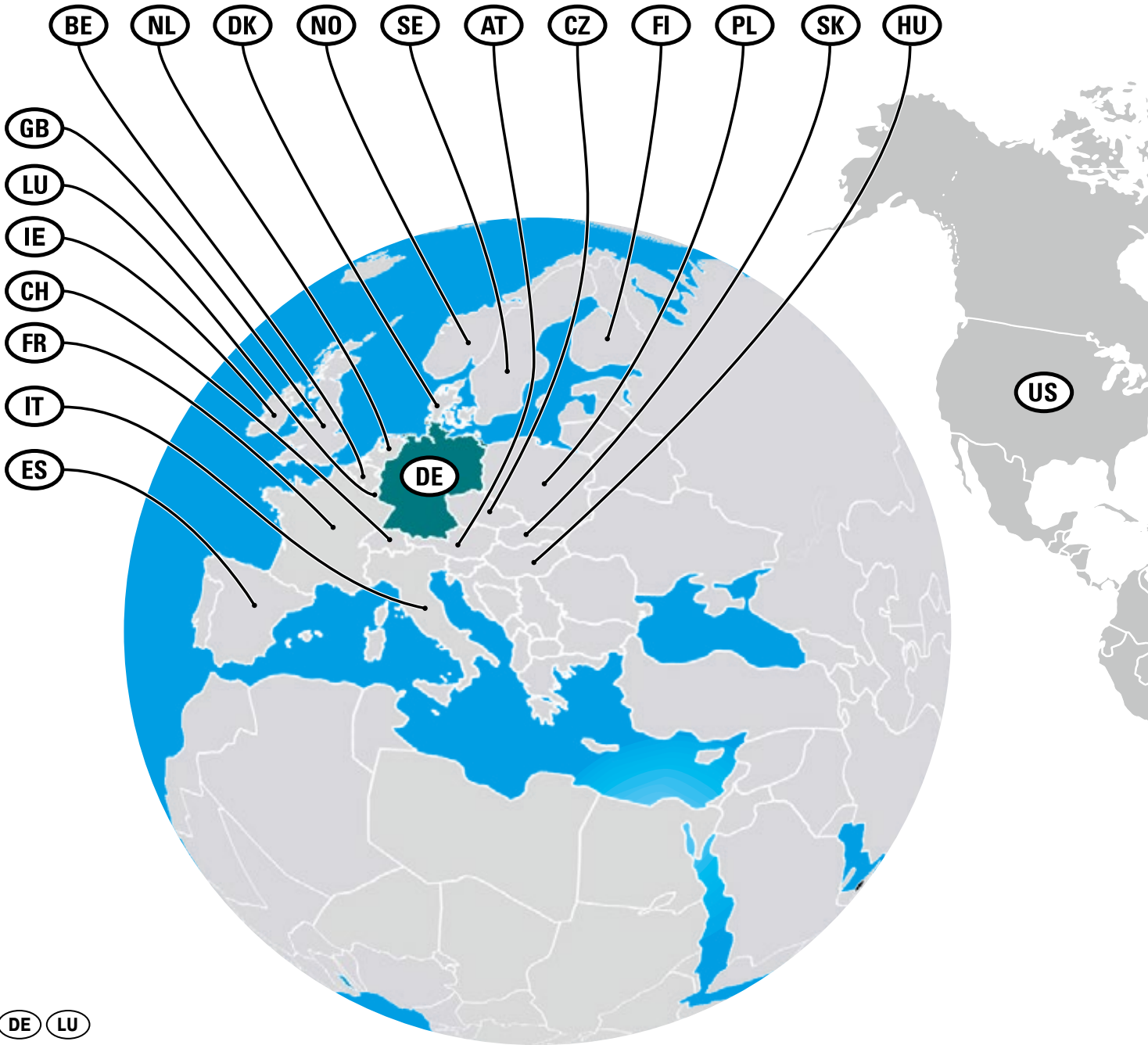

**DE LU**

**BITO-Lagertechnik  
Bittmann GmbH  
Postfach 200  
D-55587 Meisenheim**  
Tel.: +49 67 53 122-0  
Fax: +49 67 53 122-399  
E-Mail: info@bito.com  
www.bitto.com

**BITO Steel Construction GmbH  
Schloßstraße 9  
55543 Bad Kreuznach**  
E-Mail: info@bsc.bitto.com  
www.bitto-steel-construction.com

**AT**

**BITO Lagertechnik  
Austria GmbH  
Handelsring 5a  
A-4481 Asten**  
Tel.: +43 72 24 655 55-0  
Fax: +43 72 24 655 55-20  
E-Mail: info.at@bito.com  
www.bitto.com

**BE NL**

**Hoofdkantoor België:  
BITO Systems nv  
Boomsesteeweg 97  
B-2630 Aartselaar**  
Tel.: +32 3 870 99 00  
Fax: +32 3 870 99 01  
E-Mail: info.BE-NL@bito.com  
www.bitto.com

**Kantoor Nederland:  
BITO Systems nv  
Bredaseweg 185  
NL-4872 LA Etten-Leur**  
Tel.: +31 30 711 30 90  
Fax: +31 30 711 30 91  
E-Mail: info.BE-NL@bito.com  
www.bitto.com

**CH**

**BITO-Lagertechnik  
Bittmann AG  
Industriestrasse 11  
CH-6343 Rotkreuz**  
Tel.: +41 41 7 90 20 64  
Fax: +41 41 7 90 43 28  
E-Mail: info.ch@bito.com  
www.bitto.com

**FR**

**BITO SYSTEMES  
1, avenue des 22 arpents  
F-77230 MOUSSY-LE-NEUF**  
Tél. : +33 1 72 84 90 20  
Fax: +33 1 72 84 90 30  
E-Mail : info.fr@bito.com  
www.bitto.com

**GB**

**BITO STORAGE SYSTEMS LTD  
Finch Way, Hemdale Business Park  
Nuneaton  
GB-Warwickshire CV11 6WH**  
Tel.: +44 24 7638 8850  
Fax: +44 24 7638 8860  
E-Mail: info.uk@bito.com  
www.bitto.com

**IE**

**BITO LOGISTICS SOLUTIONS LIMITED  
77 Lower Camden Street  
IE-Dublin 2**  
E-Mail: Info.ie@bito.com  
www.bitto.com

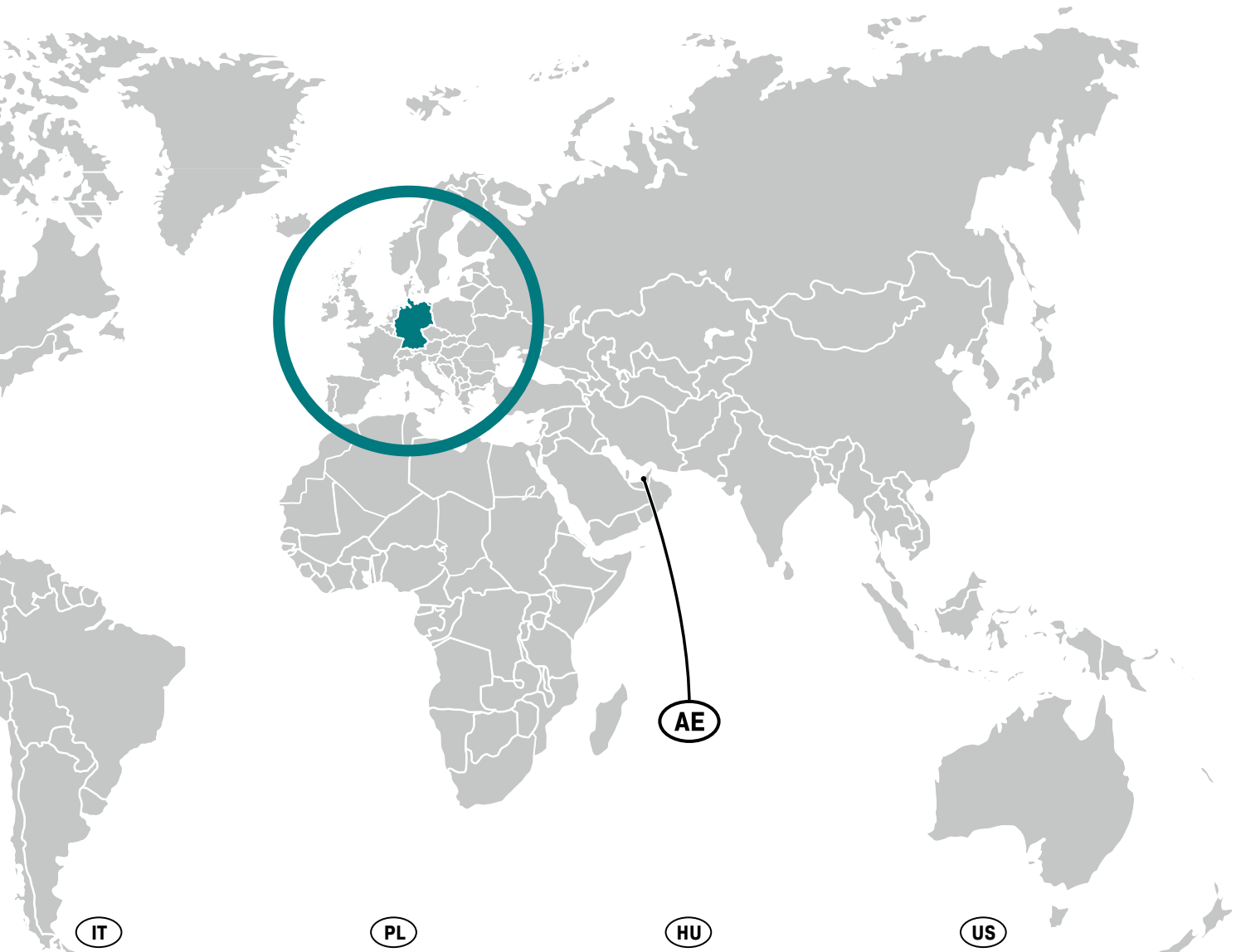
**IT**

**BITO Italia SRL**  
Via Marzabotto, 4  
I-10095 Grugliasco (TO)  
Tel.: +39 011 90 63 242  
Fax: +39 011 74 35 027  
E-Mail: info.it@bito.com  
www.bito.com

**PL**

**BITO Polska Sp. z o.o.**  
Ul. Połczyńska 116A  
01-304 Warszawa  
Tel.: +48 22 666 22 20 wew. 21  
Fax: +48 22 666 22 21  
E-Mail: info.pl@bito.com  
www.bito.com

**HU**

**BITO Raktártechnika Kft.**  
Könyves Kálmán Körút 12 - 14.  
HU-1097 Budapest  
Tel.: +36 1 421 5385  
E-Mail: info.hu@bito.com  
www.bito.com

**US**

**BITO Storage Solutions US, Inc.**  
10621 Iron Bridge Road, Suites M-N  
US-20794 Jessup (MD)  
Tel.: +1 410 892 6658  
E-Mail: sales@us.bito.com  
www.bito.com

**DK**

**BITO Storage Systems Nordic**  
Agerhatten 16C, indgang 4  
DK-5220 Odense SØ  
Tel.: +45 70 21 51 51  
Fax: +45 65 90 52 41  
E-Mail: info.dk@bito.com  
www.bito.com

**SE**

**BITO Lagersystem**  
Florettgatan 29c  
SE-254 67 Helsingborg  
Tel: +46 (0) 42 151910  
E-Mail: info.se@bito.com  
www.bito.com

**NO**

**Reolteknikk AS**  
Hellenvegen 22  
NO-2022 Gjerdrum  
Tel: +47 6393 5200  
Fax: +47 6393 5201  
E-Mail: info.no@bito.com  
www.bito.com

**ES**

**BITO Sistemas de Almacenaje, S.L.**  
Parque Empresarial @Sant Cugat  
Av. Via Augusta 15-25, Edif. B2, Pl. 9  
E-08174 Sant Cugat del Vallés (Barcelona)  
Tel.: +34 93 557 10 20  
Fax: +34 93 557 10 21  
Email: info.es@bito.com  
www.bito.com

**FI**

**BITO Varastotekniikka**  
Äyritie 12 B  
FI-01510 Vantaa  
Tel: +358 10 324 6510  
Fax: +358 9 8700 1131  
E-Mail: info.fi@bito.com  
www.bito.com

**SK**

**BITO Skladovacia technika s.r.o**  
Sládkovičova 757/38A  
SK-95701 Bánovce nad Bebravou  
Tel.: +421 38 760 00 86  
Fax: +421 38 760 00 88  
Mail: info.sk@bito.com  
www.bito.com

**CZ**

**BITO skladovací technika CZ s.r.o.**  
Sezemická 2757/2  
Horní Počernice  
CZ-193 00 PRAHA 9  
Tel.: +420 270 006 021  
Fax: +420 270 006 022  
E-Mail: info.cz@bito.com  
www.bito.com

**AE**

**BITO STORAGE SYSTEMS MIDDLE EAST DWC-LLC**  
Dubai World Central Logistics City  
DUBAI, UNITED ARAB EMIRATES  
Tel: +971 4887 9027  
Fax.: +971 4887 9754  
E-Mail: info.ae@bito.com  
www.bito.com





# Contact



## CONTACT US DIRECTLY ...

- + Our sales offices will be glad to assist you. You will find all contact data on the last pages of this catalogue.
- + Call our hotline **DK +45 70 21 51 51, SE +46 42 15 19 10, FI +358 10 324 6510**
- + Send us your requests, comments and ideas on  
DK [info.dk@bito.com](mailto:info.dk@bito.com) / SE [info.se@bito.com](mailto:info.se@bito.com) /  
FI [info.fi@bito.com](mailto:info.fi@bito.com)

## ... AT WWW.BITO.COM AND

- + for requesting comprehensive info material
- + for viewing case studies of storage and order picking systems realised by BITO
- + for keeping up to date on BITO news
- + for downloading instructions of assembly and use

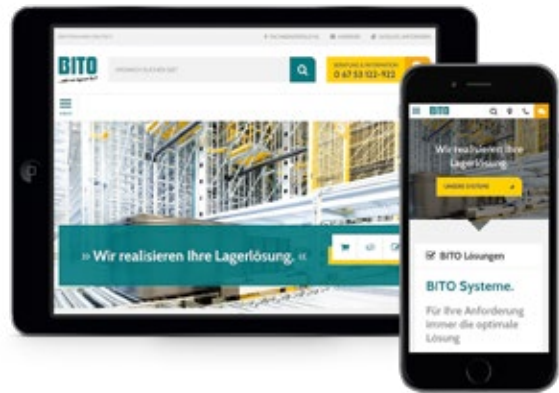

Social Media  
Connect now







# BITO is committed to the topic sustainability

Climate-neutral since 2021 – Sustainability  
is a broad field. BITO establishes it in many  
sub-areas.

You can find detailed information at [bitto.com](https://www.bitto.com)